



Choke coils for PFC dynamic characteristic data

Pin terminal type

PFC QN series

PFC3820QN

PFC3831QN

Choke coils for PFC

PFC QN series

FEATURES

- The PFC QN series achieves high power and a small floor area.
- The rated input voltage corresponds to AC220V.
- PFC output power corresponds to 800 to 900W.

CONTENTS

Part number	Height	PFC output power	Page
PFC3820QN-900K11B-00	50mm (Small floor area)	800W	3
PFC3831QN-351K08B-00	50mm (Small floor area)	900W	5
Reference circuit diagram		800 to 900W	7

PFC QN series PFC3820QN-900K11B-00

REFERENCE DYNAMIC CHARACTERISTICS

Vout = 378Vdc

Power Factor

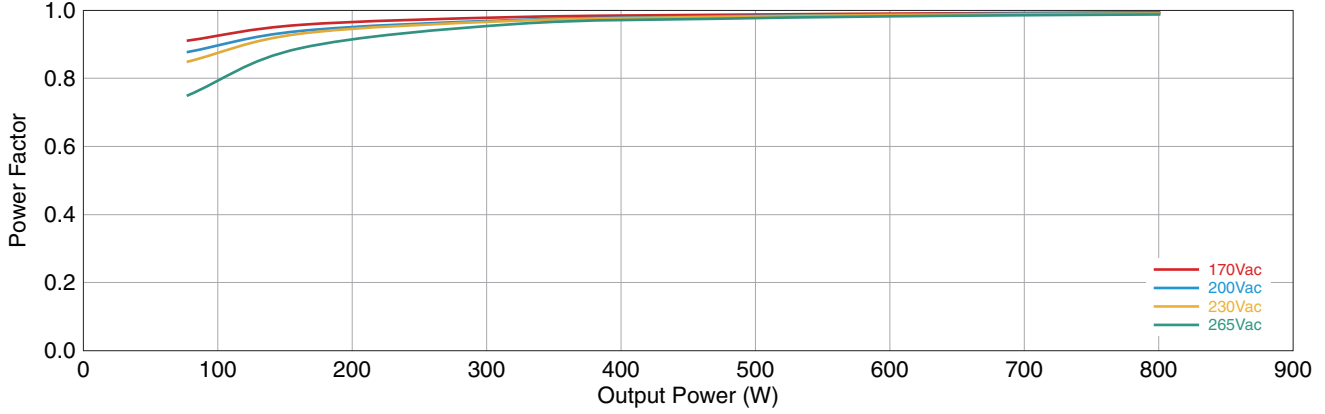

Efficiency

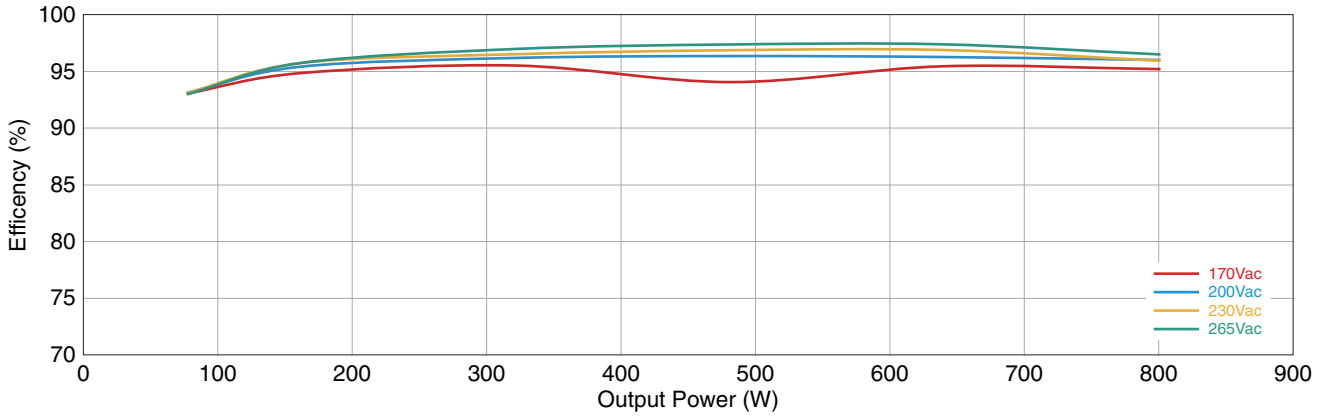

REFERENCE TEMPERATURE

Vin = 170Vac, Vout = 378Vdc, Pout = 800W, Room Temp.

a : Core Surface, b : Coil Surface

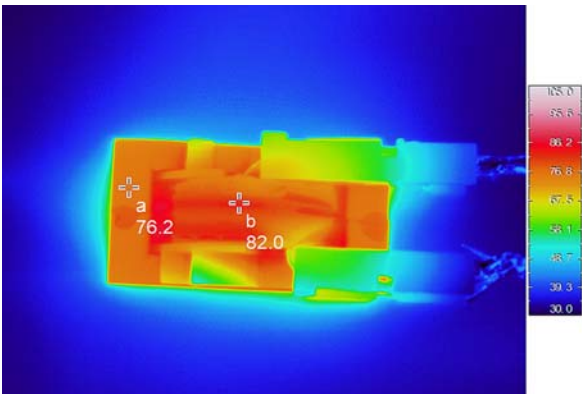

Note: The temperature of the PFC choke coil is measured while floating from the board.

 Please be sure to request delivery specifications that provide further details on the features and specifications of the products for proper and safe use. Please note that the contents may change without any prior notice due to reasons such as upgrading.

PFC QN series PFC3820QN-900K11B-00

REFERENCE OPERATING WAVEFORM

Input Voltage / Current

Vin=200Vac,Po=800W 5A/div 250V/div 10ms/div

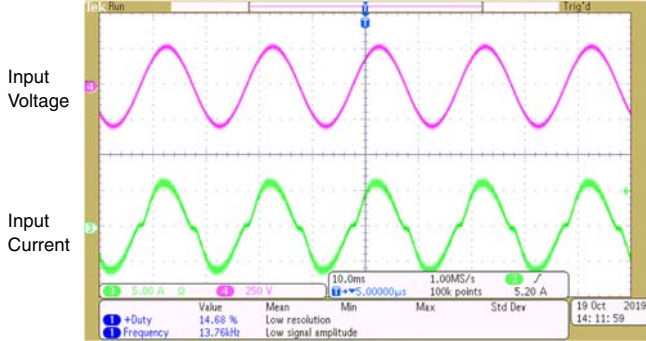

Vin=230Vac,Po=800W 5A/div 250V/div 10ms/div

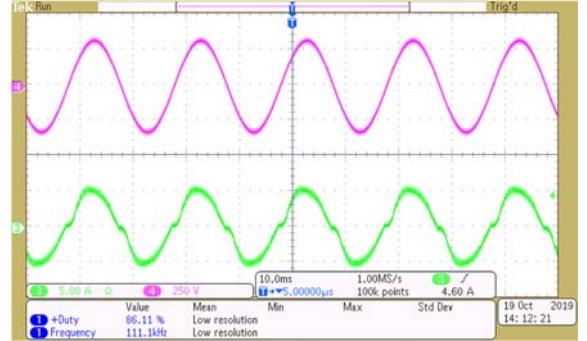

Vds / IL

Vin=200Vac,Po=800W 10A/div 250V/div 4ms/div

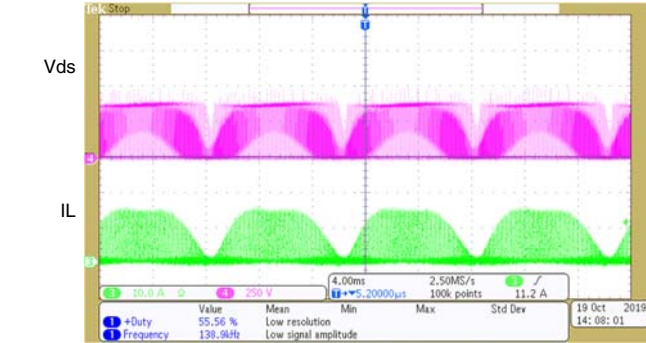

Vin=230Vac,Po=800W 10A/div 250V/div 4ms/div

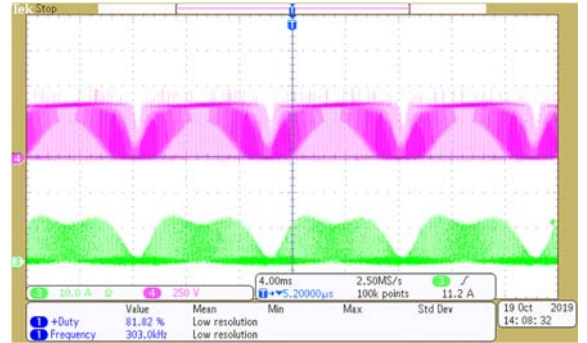

Vds / Ids

Vin=200Vac,Po=800W 10A/div 250V/div 8µs/div

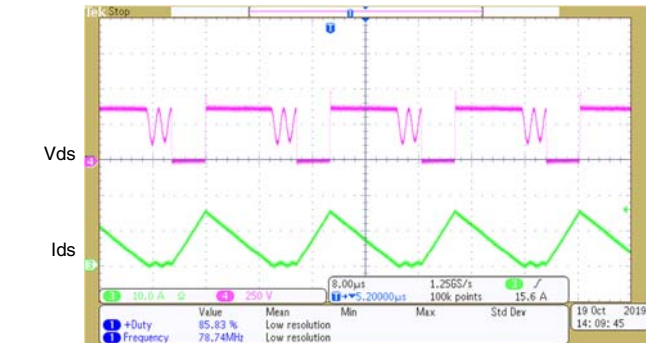

Vin=230Vac,Po=800W 10A/div 250V/div 8µs/div

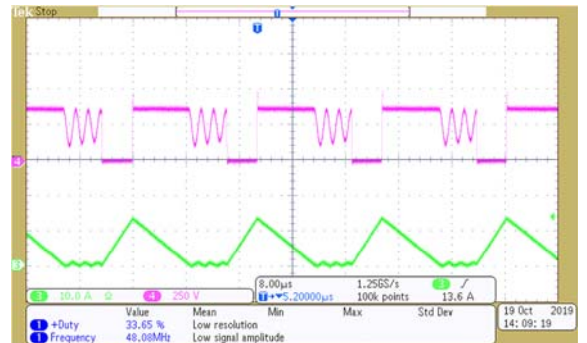

⚠ Please be sure to request delivery specifications that provide further details on the features and specifications of the products for proper and safe use. Please note that the contents may change without any prior notice due to reasons such as upgrading.

PFC QN series PFC3831QN-351K08B-00

REFERENCE DYNAMIC CHARACTERISTICS

Vout = 377Vdc

Power Factor

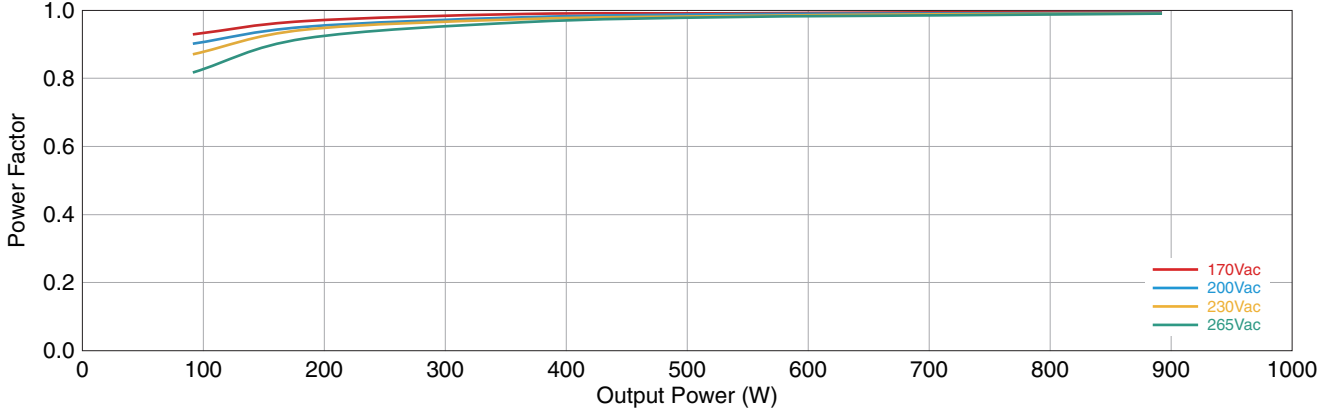

Efficiency

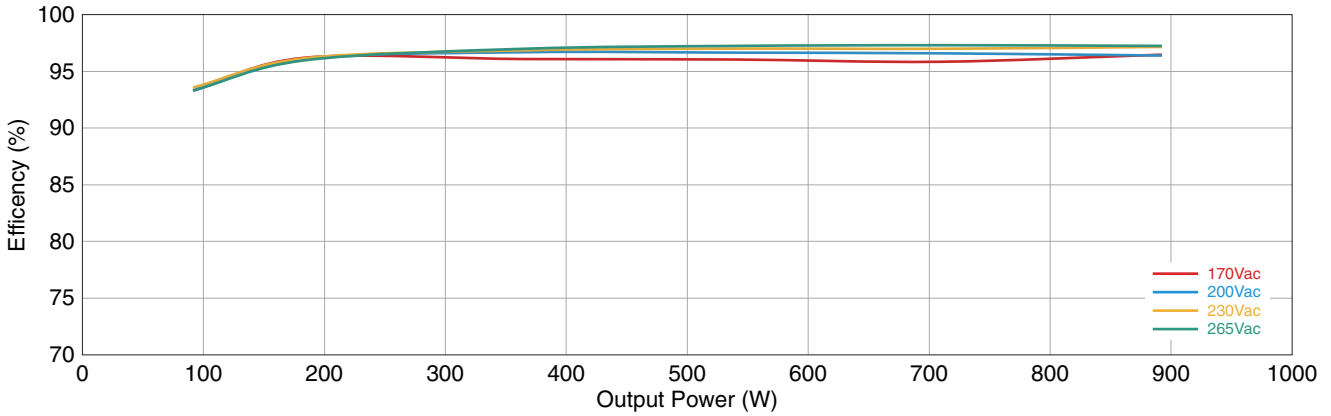

REFERENCE TEMPERATURE

Vin = 170Vac, Vout = 377Vdc, Pout = 900W, Room Temp.

a,c : Core Surface, b : Coil Surface

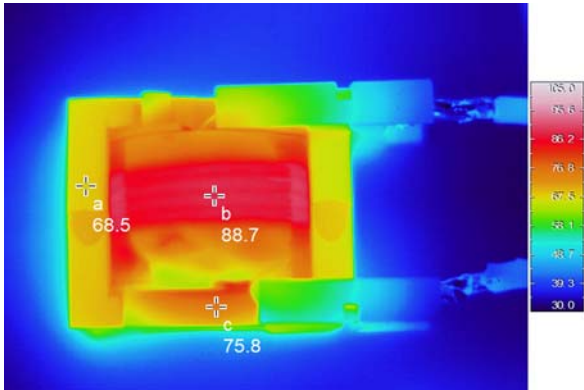

Note: The temperature of the PFC choke coil is measured while floating from the board.

 Please be sure to request delivery specifications that provide further details on the features and specifications of the products for proper and safe use. Please note that the contents may change without any prior notice due to reasons such as upgrading.

PFC QN series PFC3831QN-351K08B-00

REFERENCE OPERATING WAVEFORM

Input Voltage / Current

Vin=200Vac,Po=900W 5A/div 500V/div 10ms/div

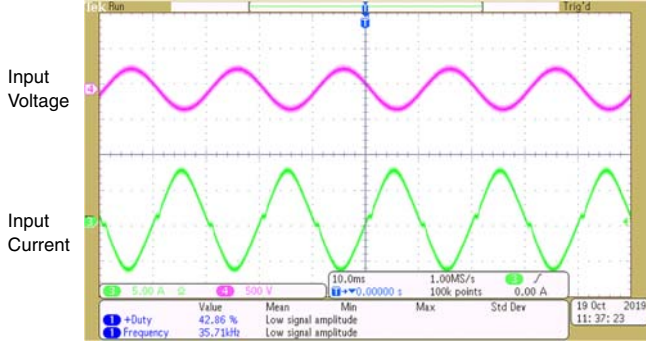

Vin=230Vac,Po=900W 5A/div 500V/div 10ms/div

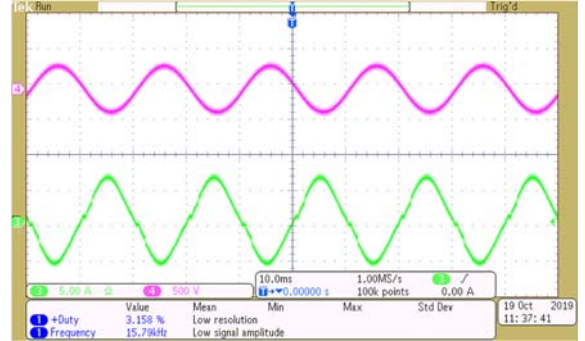

Vds / IL

Vin=200Vac,Po=900W 5A/div 250V/div 4ms/div

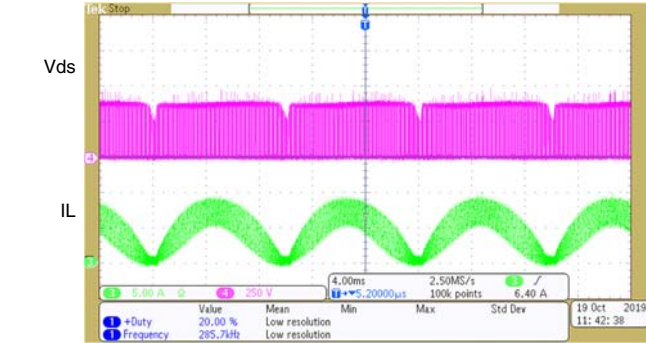

Vin=230Vac,Po=900W 5A/div 250V/div 4ms/div

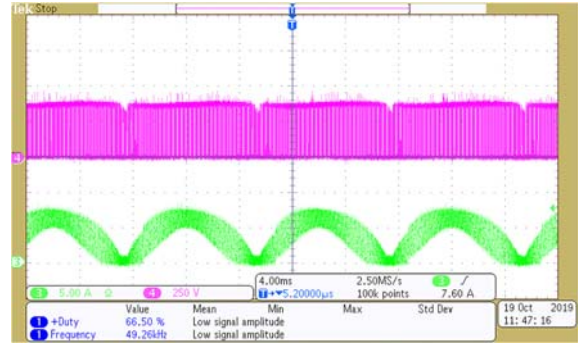

Vds / Ids

Vin=200Vac,Po=900W 5A/div 250V/div 8μs/div

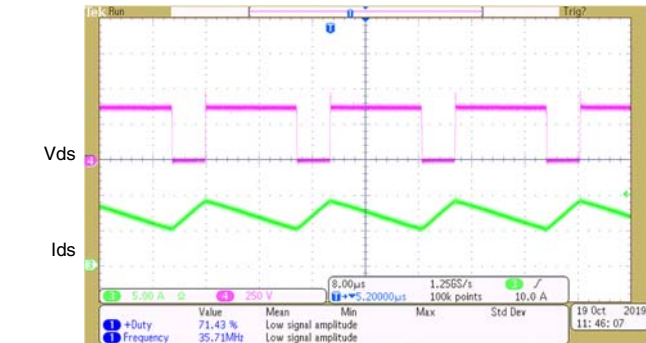

Vin=230Vac,Po=900W 5A/div 250V/div 8μs/div

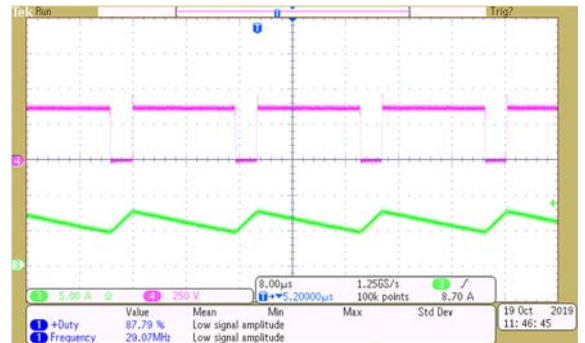

⚠ Please be sure to request delivery specifications that provide further details on the features and specifications of the products for proper and safe use. Please note that the contents may change without any prior notice due to reasons such as upgrading.

PFC QN series PFC output power : 800 to 900W

REFERENCE CIRCUIT DIAGRAM

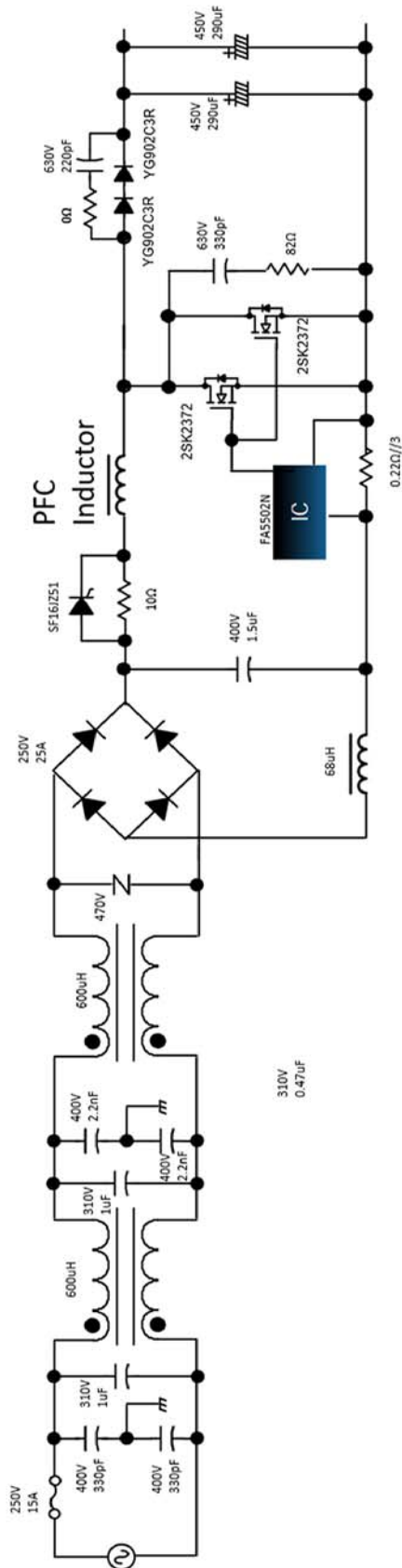

 Please be sure to request delivery specifications that provide further details on the features and specifications of the products for proper and safe use. Please note that the contents may change without any prior notice due to reasons such as upgrading.