

DELIVERY SPECIFICATION

SPEC. No. C-Soft-i

D A T E : Oct., 2023

Non-Controlled Copy

CUSTOMER'S PRODUCT NAME	TDK PRODUCT NAME MULTILAYER CERAMIC CHIP CAPACITORS(Soft Termination) Bulk and Tape packaging 【RoHS2 compliant】 C1005,C1608,C2012,C3216,C3225,C4532,C5750,C7563 Type C0G,X5R,X7R,X7S,X7T,X8R,X8L Characteristics
-------------------------	---

Please return this specification to TDK representatives with your signature.
 If orders are placed without returned specification, please allow us to judge that specification is accepted by your side.

RECEIPT CONFIRMATION

DATE: _____ YEAR MONTH DAY

TDK Corporation
 Sales
 Electronic Components
 Sales & Marketing Group

Engineering
 Electronic Components Business Company
 Ceramic Capacitors Business Group

APPROVED	Person in charge

APPROVED	CHECKED	Person in charge

SCOPE

This delivery specification shall be applied to Multilayer ceramic chip capacitors(Soft Termination Electrode) to be delivered to _____.

PRODUCTION PLACES

Production places defined in this specification shall be TDK Corporation, TDK(Suzhou)Co.,Ltd and TDK Components U.S.A.,Inc.

PRODUCT NAME

The name of the product to be defined in this specifications shall be C◇◇◇◇○○○△△□□□×◎※※※S.

REFERENCE STANDARD

JIS C 5101-1 : 2010	Fixed capacitors for use in electronic equipment-Part 1: Generic specification
C 5101-21 : 2014	Fixed capacitors for use in electronic equipment-Part 21 : Sectional specification : Fixed surface mount multilayer capacitors of ceramic dielectric,Class1
C 5101-22 : 2014	Fixed capacitors for use in electronic equipment-Part 22 : Sectional specification : Fixed surface mount multilayer capacitors of ceramic dielectric,Class2
C 0806-3 : 2014	Packaging of components for automatic handling - Part 3: Packaging of surface mount components on continuous tapes
JEITA RCR-2335 C 2014	Safety application guide for fixed ceramic capacitors for use in electronic equipment

CONTENTS

1. CODE CONSTRUCTION
2. COMBINATION OF RATED CAPACITANCE AND TOLERANCE
3. OPERATING TEMPERATURE RANGE
4. STORING CONDITION AND TERM
5. P.C. BOARD
6. INDUSTRIAL WASTE DISPOSAL
7. PERFORMANCE
8. INSIDE STRUCTURE AND MATERIAL
9. CAUTION FOR PRODUCTS WITH SOFT TERMINATION
10. PACKAGING
11. RECOMMENDATION
12. SOLDERING CONDITION
13. CAUTION
14. TAPE PACKAGING SPECIFICATION

<EXPLANATORY NOTE>

When the mistrust in the spec arises, this specification is given priority. And it will be confirmed by written spec change after conference of both posts involved.

This specification warrants the quality of the ceramic chip capacitor. Capacitors should be evaluated or confirmed a state of mounted on your product.

If the use of the capacitors goes beyond the bounds of this specification, we can not afford to guarantee.

Division	Date	SPEC. No.
Ceramic Capacitors Business Group	October, 2023	C-Soft-i

1. CODE CONSTRUCTION

(Example) $\frac{C2012}{(1)}$ $\frac{X7R}{(2)}$ $\frac{1H}{(3)}$ $\frac{105}{(4)}$ $\frac{K}{(5)}$ $\frac{T}{(6)}$ $\frac{\times\times\times S}{(7)}$

(1) Case size

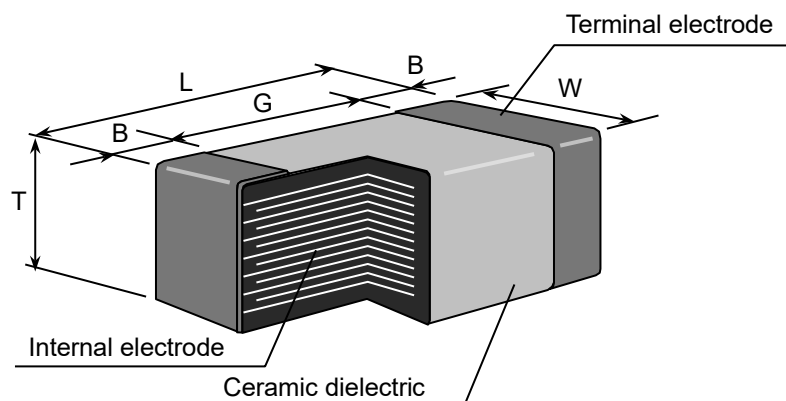

Type	Dimensions (Unit : mm)				
TDK[EIA style]	L	W	T	B	G
C1005 [CC0402]	$1.00^{+0.15}_{-0.05}$	$0.50^{+0.10}_{-0.05}$	$0.50^{+0.10}_{-0.05}$	0.10 min.	0.30 min.
	$1.00^{+0.25}_{-0.10}$	$0.50^{+0.20}_{-0.10}$	$0.50^{+0.20}_{-0.10}$		
C1608 [CC0603]	$1.60^{+0.20}_{-0.10}$	$0.80^{+0.15}_{-0.10}$	$0.80^{+0.15}_{-0.10}$	0.20 min.	0.30 min.
C2012 [CC0805]	$2.00^{+0.45}_{-0.20}$	$1.25^{+0.25}_{-0.20}$	0.60 ± 0.15	0.20 min.	0.50 min.
			0.85 ± 0.15		
			$1.25^{+0.25}_{-0.20}$		
C3216 [CC1206]	$3.20^{+0.40}_{-0.20}$	$1.60^{+0.30}_{-0.20}$	0.85 ± 0.15	0.20 min.	1.00 min.
			1.15 ± 0.15		
			1.30 ± 0.20		
C3225 [CC1210]	$3.20^{+0.50}_{-0.40}$	2.50 ± 0.30	$1.60^{+0.30}_{-0.20}$	0.20 min.	—
			$2.00^{+0.30}_{-0.20}$		
			$2.30^{+0.30}_{-0.20}$		
			2.50 ± 0.30		
C4532 [CC1812]	$4.50^{+0.50}_{-0.40}$	3.20 ± 0.40	$2.00^{+0.30}_{-0.20}$	0.20 min.	—
			$2.30^{+0.30}_{-0.20}$		
			2.50 ± 0.30		
C5750 [CC2220]	$5.70^{+0.50}_{-0.40}$	5.00 ± 0.40	$2.30^{+0.30}_{-0.20}$	0.20 min.	—
			2.50 ± 0.30		
C7563 [CC3025]	7.50 ± 0.50	6.30 ± 0.50	2.50 max.	0.30 min.	—
			3.00 max.		

* As for each item, please refer to detail page on TDK web.

(2) Temperature Characteristics

* Details are shown in table 1 No.6 and No.7 at 7.PERFORMANCE

(3) Rated Voltage

Symbol	Rated Voltage	Symbol	Rated Voltage
2 J	DC 630 V	1 V	DC 35 V
2 W	DC 450 V	1 E	DC 25 V
2 E	DC 250 V	1 C	DC 16 V
2 A	DC 100 V	1 A	DC 10 V
1 H	DC 50 V	0 J	DC 6.3 V

(4) Rated Capacitance

Stated in three digits and in units of pico farads (pF).
The first and Second digits identify the first and second significant figures of the capacitance, the third digit identifies the multiplier.

(Example)

Symbol	Rated Capacitance
105	1,000,000 pF

(5) Capacitance tolerance

* M tolerance shall be standard for over 10uF.

Symbol	Tolerance
J	± 5 %
K	± 10 %
*M	± 20 %

(6) Packaging

* C1005 type is applicable to tape packaging only.

Symbol	Packaging
B	Bulk
T	Taping

(7) TDK internal code

※※※ S

S : Soft Termination

These TDK internal codes are subject to change without notice.

2. COMBINATION OF RATED CAPACITANCE AND TOLERANCE

Class	Temperature Characteristics	Capacitance tolerance	Rated capacitance
1	C0G	J ($\pm 5\%$)	E – 12 series
2	X5R X7R X7S X7T X8R X8L	K ($\pm 10\%$) M ($\pm 20\%$)	E – 6 series

Capacitance Step in E series

E series	Capacitance Step											
E-6	1.0		1.5		2.2		3.3		4.7		6.8	
E-12	1.0	1.2	1.5	1.8	2.2	2.7	3.3	3.9	4.7	5.6	6.8	8.2

3. OPERATING TEMPERATURE RANGE

T.C.	Min. operating Temperature	Max. operating Temperature	Reference Temperature
X5R	-55°C	85°C	25°C
C0G/X7R/X7S/X7T	-55°C	125°C	25°C
X8R/X8L	-55°C	150°C	25°C

4. STORING CONDITION AND TERM

Storing temperature	Storing humidity	Storing term
5~40°C	20~70%RH	Within 6 months upon receipt.

5. P.C. BOARD

When mounting on an aluminum substrate, the capacitors are more likely to be affected by heat stress from the substrate.

Please inquire separate specification when mounted on the substrate.

6. INDUSTRIAL WASTE DISPOSAL

Dispose this product as industrial waste in accordance with the Industrial Waste Law.

7. PERFORMANCE

table 1

No.	Item	Performance	Test or inspection method																	
1	External Appearance	No defects which may affect performance.	Inspect with magnifying glass (3×)																	
2	Insulation Resistance	Please refer to detail page on TDK web.	Measuring voltage : Rated voltage (As for the capacitor of rated voltage 630V DC, apply 500V DC.) Voltage application time : 60s.																	
3	Voltage Proof	Withstand test voltage without insulation breakdown or other damage.	<table border="1"> <thead> <tr> <th>Class</th> <th>Rated voltage(RV)</th> <th>Apply voltage</th> </tr> </thead> <tbody> <tr> <td rowspan="2">1</td> <td>$RV \leq 100V$</td> <td>3 × rated voltage</td> </tr> <tr> <td>$100V < RV$</td> <td>1.5 × rated voltage</td> </tr> <tr> <td rowspan="3">2</td> <td>$RV \leq 100V$</td> <td>2.5 × rated voltage</td> </tr> <tr> <td>$100V < RV \leq 500V$</td> <td>1.5 × rated voltage</td> </tr> <tr> <td>$500V < RV$</td> <td>1.3 × rated voltage</td> </tr> </tbody> </table> <p>Voltage application time : 1s. Charge / discharge current : 50mA or lower</p>	Class	Rated voltage(RV)	Apply voltage	1	$RV \leq 100V$	3 × rated voltage	$100V < RV$	1.5 × rated voltage	2	$RV \leq 100V$	2.5 × rated voltage	$100V < RV \leq 500V$	1.5 × rated voltage	$500V < RV$	1.3 × rated voltage		
Class	Rated voltage(RV)	Apply voltage																		
1	$RV \leq 100V$	3 × rated voltage																		
	$100V < RV$	1.5 × rated voltage																		
2	$RV \leq 100V$	2.5 × rated voltage																		
	$100V < RV \leq 500V$	1.5 × rated voltage																		
	$500V < RV$	1.3 × rated voltage																		
4	Capacitance	Within the specified tolerance.	<p>《Class1》</p> <table border="1"> <thead> <tr> <th>Capacitance</th> <th>Measuring frequency</th> <th>Measuring voltage</th> </tr> </thead> <tbody> <tr> <td>1000pF and under</td> <td>1MHz±10%</td> <td rowspan="2">0.5 - 5 Vrms.</td> </tr> <tr> <td>Over 1000pF</td> <td>1kHz±10%</td> </tr> </tbody> </table> <p>《Class2》</p> <table border="1"> <thead> <tr> <th>Capacitance</th> <th>Measuring frequency</th> <th>Measuring voltage</th> </tr> </thead> <tbody> <tr> <td>10uF and under</td> <td>1kHz±10%</td> <td>1.0±0.2Vrms</td> </tr> <tr> <td>Over 10uF</td> <td>120Hz±20%</td> <td>0.5±0.2Vrms.</td> </tr> </tbody> </table> <p>As for measuring condition, please contact with our sales representative.</p>	Capacitance	Measuring frequency	Measuring voltage	1000pF and under	1MHz±10%	0.5 - 5 Vrms.	Over 1000pF	1kHz±10%	Capacitance	Measuring frequency	Measuring voltage	10uF and under	1kHz±10%	1.0±0.2Vrms	Over 10uF	120Hz±20%	0.5±0.2Vrms.
Capacitance	Measuring frequency	Measuring voltage																		
1000pF and under	1MHz±10%	0.5 - 5 Vrms.																		
Over 1000pF	1kHz±10%																			
Capacitance	Measuring frequency	Measuring voltage																		
10uF and under	1kHz±10%	1.0±0.2Vrms																		
Over 10uF	120Hz±20%	0.5±0.2Vrms.																		
5	Q (Class1) Dissipation Factor (Class2)	Please refer to detail page on TDK web.	See No.4 in this table for measuring condition.																	
6	Temperature Characteristics of Capacitance (Class1)	<table border="1"> <thead> <tr> <th>T.C.</th> <th>Temperature Coefficient</th> </tr> </thead> <tbody> <tr> <td>C0G</td> <td>0 ± 30 (ppm/°C)</td> </tr> </tbody> </table> <p>Capacitance drift within ± 0.2% or ± 0.05pF, whichever larger.</p>	T.C.	Temperature Coefficient	C0G	0 ± 30 (ppm/°C)	<p>Temperature coefficient shall be calculated based on values at 25°C and 85°C temperature.</p> <p>Measuring temperature below 25°C shall be -10°C and -25°C.</p>													
T.C.	Temperature Coefficient																			
C0G	0 ± 30 (ppm/°C)																			

(continued)

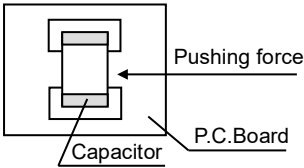
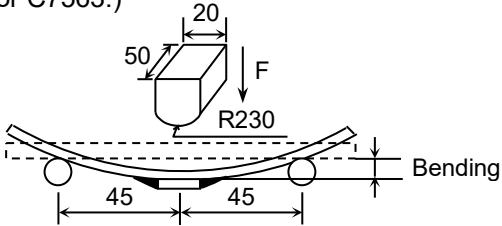
No.	Item	Performance	Test or inspection method										
7	Temperature Characteristics of Capacitance (Class2)	<p style="text-align: center;">Capacitance Change (%)</p> <hr/> <p style="text-align: center;">No voltage applied</p> <hr/> <p style="text-align: center;">X5R : ± 15 X7R : ± 15 X7S : ± 22</p> <p style="text-align: center;">X7T : $\begin{matrix} +22 \\ -33 \end{matrix}$</p> <p style="text-align: center;">X8R : ± 15</p> <p style="text-align: center;">X8L : $\begin{matrix} +15 \\ -40 \end{matrix}$</p> <hr/>	<p>Capacitance shall be measured by the steps shown in the following table after thermal equilibrium is obtained for each step. ΔC be calculated ref. STEP3 reading</p> <table border="1" data-bbox="965 389 1430 707"> <thead> <tr> <th>Step</th> <th>Temperature(°C)</th> </tr> </thead> <tbody> <tr> <td>1</td> <td>Reference temp. ± 2</td> </tr> <tr> <td>2</td> <td>Min. operating temp. ± 2</td> </tr> <tr> <td>3</td> <td>Reference temp. ± 2</td> </tr> <tr> <td>4</td> <td>Max. operating temp. ± 2</td> </tr> </tbody> </table> <p>As for Min./Max. operating temp and Reference temp., please refer to "3. OPERATING TEMPERATURE RANGE" As for measuring voltage, please contact with our sales representative.</p>	Step	Temperature(°C)	1	Reference temp. ± 2	2	Min. operating temp. ± 2	3	Reference temp. ± 2	4	Max. operating temp. ± 2
Step	Temperature(°C)												
1	Reference temp. ± 2												
2	Min. operating temp. ± 2												
3	Reference temp. ± 2												
4	Max. operating temp. ± 2												
8	Robustness of Terminations	No sign of termination coming off, breakage of ceramic, or other abnormal signs.	<p>Reflow solder the capacitors on a P.C.Board shown in Appendix 2. Apply a pushing force gradually at the center of a specimen in a horizontal direction of P.C.board. Pushing force : 5N (2N is applied for C1005 type.) Holding time : 10±1s.</p> 										
9	Bending	External appearance	<p>No mechanical damage.</p> <p>Reflow solder the capacitors on a P.C.Board shown in Appendix 1 and bend it for 5mm. (2mm is applied for C4532 and C5750. 1mm is applied for C7563.)</p>  <p style="text-align: right;">(Unit : mm)</p>										

(continued)

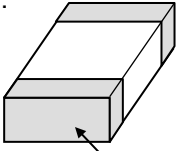
No.	Item	Performance	Test or inspection method									
10	Solderability	<p>New solder to cover over 75% of termination. 25% may have pin holes or rough spots but not concentrated in one spot. Ceramic surface of A sections shall not be exposed due to melting or shifting of termination material.</p>  <p style="text-align: center;">A section</p>	<p>Solder : Sn-3.0Ag-0.5Cu</p> <p>Flux : Isopropyl alcohol (JIS K 8839) Rosin (JIS K 5902) 25% solid solution.</p> <p>Solder temp. : 245±5°C</p> <p>Dwell time : 3±0.3s.</p> <p>Solder position : Until both terminations are completely soaked.</p>									
11	Resistance to solder heat	<p>External appearance</p> <p>No cracks are allowed and terminations shall be covered at least 60% with new solder.</p> <p>Capacitance</p> <table border="1" data-bbox="534 884 917 1164"> <thead> <tr> <th colspan="2">Characteristics</th> <th>Change from the value before test</th> </tr> </thead> <tbody> <tr> <td>Class1</td> <td>C0G</td> <td>± 2.5 %</td> </tr> <tr> <td>Class2</td> <td>X5R X7R X7S X7T X8R X8L</td> <td>± 7.5 %</td> </tr> </tbody> </table> <p>Q (Class1)</p> <p>Meet the initial spec.</p> <p>D.F. (Class2)</p> <p>Meet the initial spec.</p> <p>Insulation Resistance</p> <p>Meet the initial spec.</p> <p>Voltage proof</p> <p>No insulation breakdown or other damage.</p>	Characteristics		Change from the value before test	Class1	C0G	± 2.5 %	Class2	X5R X7R X7S X7T X8R X8L	± 7.5 %	<p>Solder : Sn-3.0Ag-0.5Cu</p> <p>Flux : Isopropyl alcohol (JIS K 8839) Rosin (JIS K 5902) 25% solid solution.</p> <p>Solder temp. : 260±5°C</p> <p>Dwell time : 10±1s.</p> <p>Solder position : Until both terminations are completely soaked.</p> <p>Pre-heating : Temp. — 110~140°C Time — 30~60s.</p> <p>Leave the capacitors in ambient condition for Class 1 : 6~24h Class 2 : 24±2h before measurement.</p>
Characteristics		Change from the value before test										
Class1	C0G	± 2.5 %										
Class2	X5R X7R X7S X7T X8R X8L	± 7.5 %										
12	Vibration	<p>External appearance</p> <p>No mechanical damage.</p> <p>Capacitance</p> <table border="1" data-bbox="534 1601 917 1904"> <thead> <tr> <th colspan="2">Characteristics</th> <th>Change from the value before test</th> </tr> </thead> <tbody> <tr> <td>Class1</td> <td>C0G</td> <td>± 2.5 %</td> </tr> <tr> <td>Class2</td> <td>X5R X7R X7S X7T X8R X8L</td> <td>± 7.5 %</td> </tr> </tbody> </table> <p>Q (Class1)</p> <p>Meet the initial spec.</p> <p>D.F. (Class2)</p> <p>Meet the initial spec.</p>	Characteristics		Change from the value before test	Class1	C0G	± 2.5 %	Class2	X5R X7R X7S X7T X8R X8L	± 7.5 %	<p>Frequency : 10~55~10Hz</p> <p>Reciprocating sweep time : 1 min.</p> <p>Amplitude : 1.5mm</p> <p>Repeat this for 2h each in 3 perpendicular directions(Total 6h).</p> <p>Reflow solder the capacitors on a P.C.Board shown in Appendix 2 before testing.</p>
Characteristics		Change from the value before test										
Class1	C0G	± 2.5 %										
Class2	X5R X7R X7S X7T X8R X8L	± 7.5 %										

(continued)

No.	Item		Performance	Test or inspection method															
13	Temperature cycle	External appearance	No mechanical damage.	Expose the capacitors in the condition step1 through step 4 listed in the following table. Temp. cycle : 5 cycles <table border="1"> <thead> <tr> <th>Step</th> <th>Temperature(°C)</th> <th>Time (min.)</th> </tr> </thead> <tbody> <tr> <td>1</td> <td>Min. operating temp.±3</td> <td>30 ± 3</td> </tr> <tr> <td>2</td> <td>Ambient Temp.</td> <td>2 ~ 5</td> </tr> <tr> <td>3</td> <td>Max. operating temp.±2</td> <td>30 ± 2</td> </tr> <tr> <td>4</td> <td>Ambient Temp.</td> <td>2 ~ 5</td> </tr> </tbody> </table> As for Min./Max. operating temp., please refer to "3. OPERATING TEMPERATURE RANGE" Leave the capacitors in ambient condition for Class 1 : 6~24h Class 2 : 24±2h before measurement. Reflow solder the capacitors on a P.C.Board shown in Appendix2 before testing.	Step	Temperature(°C)	Time (min.)	1	Min. operating temp.±3	30 ± 3	2	Ambient Temp.	2 ~ 5	3	Max. operating temp.±2	30 ± 2	4	Ambient Temp.	2 ~ 5
		Step	Temperature(°C)		Time (min.)														
		1	Min. operating temp.±3		30 ± 3														
		2	Ambient Temp.		2 ~ 5														
		3	Max. operating temp.±2		30 ± 2														
		4	Ambient Temp.		2 ~ 5														
		Capacitance	Characteristics		Change from the value before test														
Class1	C0G		Please contact with our sales representative.																
Class2	X5R																		
	X7R																		
X7S																			
X7T																			
X8R																			
X8L																			
Q (Class1)	Meet the initial spec.																		
D.F. (Class2)	Meet the initial spec.																		
Insulation Resistance	Meet the initial spec.																		
Voltage proof	No insulation breakdown or other damage.																		
14	Moisture Resistance (Steady State)	External appearance	No mechanical damage.	Test temp. : 40±2°C Test humidity : 90~95%RH Test time : 500 +24,0h Leave the capacitors in ambient condition for Leave the capacitors in ambient condition for Class 1 : 6~24h Class 2 : 24±2h before measurement. Reflow solder the capacitors on a P.C.Board shown in Appendix2 before testing.															
		Capacitance	Characteristics		Change from the value before test														
			Class1		C0G	Please contact with our sales representative.													
		Class2	X5R																
			X7R																
X7S																			
X7T																			
X8R																			
X8L																			
Q (Class1)	350 min.																		
D.F. (Class2)	200% of initial spec. max.																		
Insulation Resistance	Please contact with our sales representative.																		

(continued)

No.	Item		Performance		Test or inspection method	
15	Moisture Resistance	External appearance	No mechanical damage.		Test temp. : 40±2°C Test humidity : 90~95%RH Applied voltage : Rated voltage Test time : 500 +24,0h Charge/discharge current : 50mA or lower Leave the capacitors in ambient condition for Class 1 : 6~24h Class 2 : 24±2h before measurement. Reflow solder the capacitors on a P.C.Board shown in Appendix2 before testing. Initial value setting (only for class 2) Voltage conditioning «After voltage treat the capacitors under testing temperature and voltage for 1 hour,» leave the capacitors in ambient condition for 24±2h before measurement. Use this measurement for initial value.	
		Capacitance	Characteristics			Change from the value before test
			Class1	C0G		Please contact with our sales representative.
			Class2	X5R X7R X7S X7T X8R X8L		
		Q (Class1)		200 min.		
D.F. (Class2)	200% of initial spec. max.					
Insulation Resistance	Please contact with our sales representative.					
16	Life	External appearance	No mechanical damage.		Test temp. : Maximum operating temperature±2°C Applied voltage : Please contact with our sales representative. Test time : 1,000 +48,0h Charge/discharge current : 50mA or lower Leave the capacitors in ambient condition for Class 1 : 6~24h Class 2 : 24±2h before measurement. Reflow solder the capacitors on a P.C.Board shown in Appendix2 before testing. Initial value setting (only for class 2) Voltage conditioning «After voltage treat the capacitors under testing temperature and voltage for 1 hour,» leave the capacitors in ambient condition for 24±2h before measurement. Use this measurement for initial value.	
		Capacitance	Characteristics			Change from the value before test
			Class1	C0G		Please contact with our sales representative.
			Class2	X5R X7R X7S X7T X8R X8L		
		Q (Class1)		350 min.		
D.F. (Class2)	200% of initial spec. max.					
Insulation Resistance	Please contact with our sales representative.					

*As for the initial measurement of capacitors (Class2) on number 7,11,12,13 and 14 leave capacitors at 150 –10,0°C for 1 hour and measure the value after leaving capacitors for 24±2h in ambient condition.

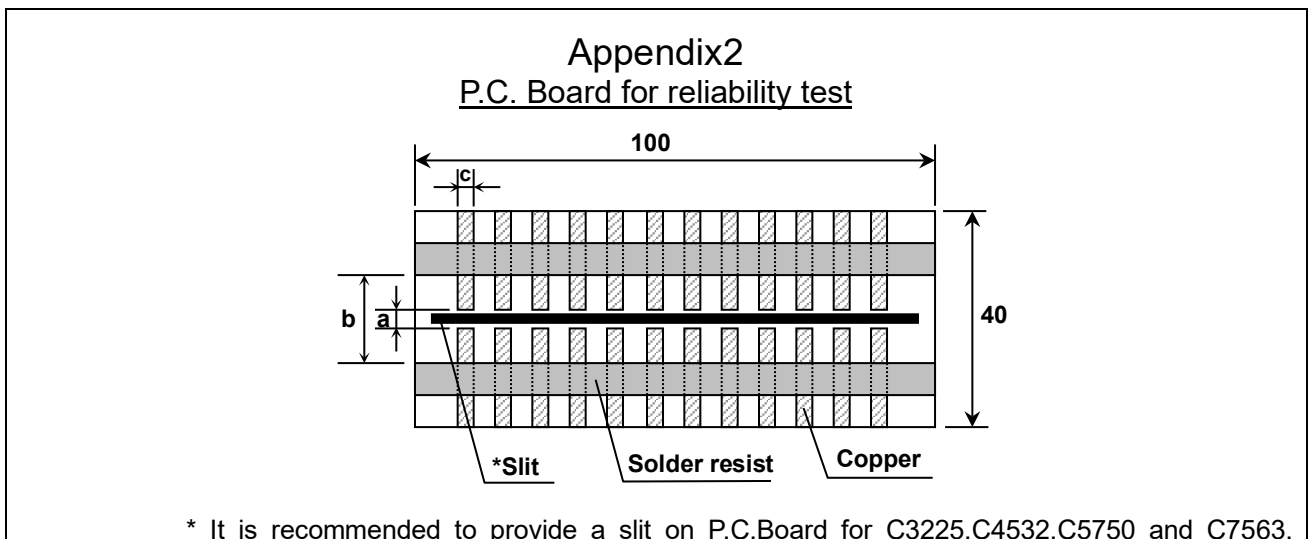
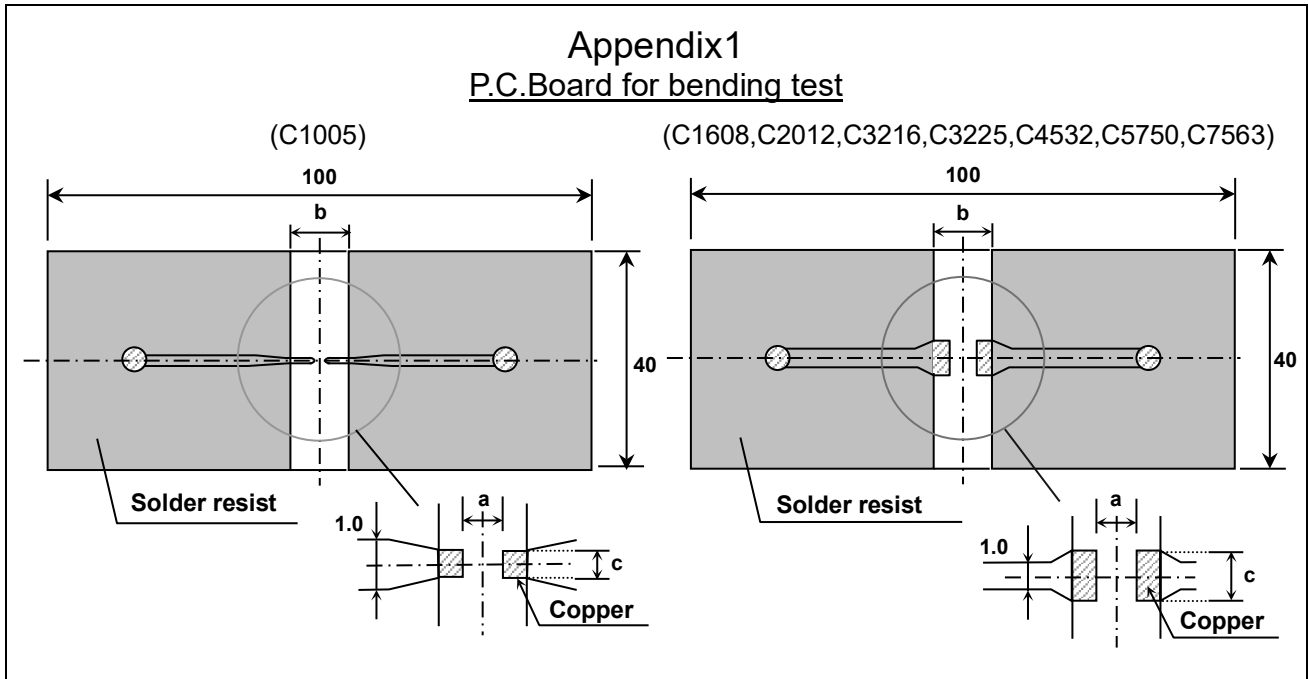

(Unit : mm)

Case size \ Symbol	a	b	c
C1005 [CC0402]	0.4	1.5	0.5
C1608 [CC0603]	1.0	3.0	1.2
C2012 [CC0805]	1.2	4.0	1.65
C3216 [CC1206]	2.2	5.0	2.0
C3225 [CC1210]	2.2	5.0	2.9
C4532 [CC1812]	3.5	7.0	3.7
C5750 [CC2220]	4.5	8.0	5.6
C7563 [CC3025]	5.5	9.1	6.9

1. Material : Glass Epoxy(As per JIS C6484 GE4)
2. Thickness : Appendix 1 — 0.8mm (C1005)
 — 1.6mm (C1608,C2012,C3216,C3225,C4532,C5750,C7563)
 : Appendix 2 — 1.6mm

Copper(Thickness:0.035mm)
 Solder resist

8. INSIDE STRUCTURE AND MATERIAL

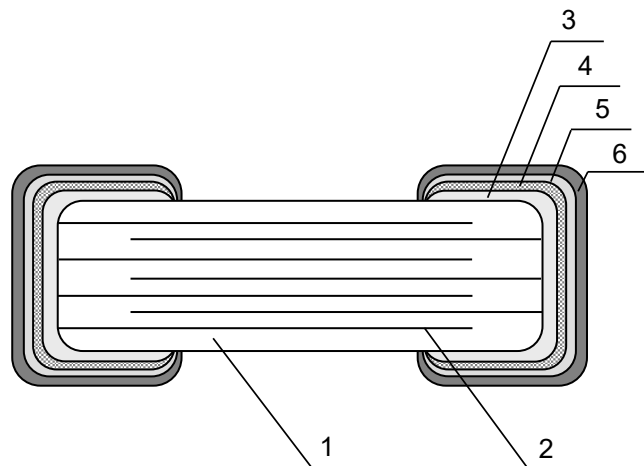

No.	NAME	MATERIAL	
		Class1	Class2
1	Dielectric	CaZrO ₃	BaTiO ₃
2	Electrode	Nickel (Ni)	
3	Termination	Copper (Cu)	
4		Conductive resin (Filler : Ag)	
5		Nickel (Ni)	
6		Tin (Sn)	

9. CAUTION FOR PRODUCTS WITH SOFT TERMINATION

This product contains Ag (Silver) as part of the middle layer of termination.

To avoid electromigration of Ag under high temperature and humidity, and failures caused by corrosive gas, chip capacitors on P.C boards should be protected by moisture proof-sealing.

10. PACKAGING

Packaging shall be done to protect the components from the damage during transportation and storing, and a label which has the following information shall be attached.

10.1 Each plastic bag for bulk packaging contains 1000pcs. And the minimum quantity for Bulk packaging is 1000pcs.

10.2 Tape packaging is as per 14. TAPE PACKAGING SPECIFICATION

. *C1005[CC0402] type is applicable to tape packaging only.

- 1) Inspection No.*
- 2) TDK P/N
- 3) Customer's P/N
- 4) Quantity

*Composition of Inspection No.

Example E 3 A - 23 - 001
 (a) (b) (c) (d) (e)

- (a) Line code
- (b) Last digit of the year
- (c) Month and A for January and B for February and so on. (Skip I)
- (d) Inspection Date of the month.
- (e) Serial No. of the day

*Composition of new Inspection No.

(Implemented on and after May 1, 2019 in sequence)

Example

I	F	3	E	2	3	A	0	0	1
---	---	---	---	---	---	---	---	---	---

 (a) (b) (c) (d) (e) (f) (g)

- (a) Prefix
- (b) Line code
- (c) Last digit of the year
- (d) Month and A for January and B for February and so on. (Skip I)
- (e) Inspection Date of the month.
- (f) Serial No. of the day(00 ~ ZZ)
- (g) Suffix(00 ~ ZZ)

*It was shifted to the new inspection No. on and after May 2019, but the implementation timing may be different depending on shipment bases.

Until the shift is completed, either current or new composition of inspection No. will be applied.

11. RECOMMENDATION

As for C3225 [CC1210] and larger, It is recommended to provide a slit (about 1mm wide) in the board under the components to improve washing Flux. And please make sure to dry detergent up completely before.

12. SOLDERING CONDITION

As for C1005[CC0402], C3225[CC1210] and larger, reflow soldering only. For other case sizes than the above, reflow soldering is recommended.

13. CAUTION

No.	Process	Condition
1	Operating Condition (Storage, Use, Transportation)	<p>1-1. Storage, Use The capacitors must be stored in an ambient temperature of 5 to 40°C with a relative humidity of 20 to 70%RH. JIS C 60721-3-1 Class 1K2 should be followed for the other climatic conditions.</p> <p>1) High temperature and humidity environment may affect a capacitor's solder ability because it accelerates terminal oxidization. They also deteriorate performance of taping and packaging. Therefore, SMD capacitors shall be used within 6 months. For capacitors with terminal electrodes consisting of silver or silver-palladium which tend to become oxidized or sulfurized, use as soon as possible, such as within one month after opening the bag.</p> <p>2) When capacitors are stored for a longer time period than 6 months, confirm the solderability of the capacitors prior to use. During storage, keep the minimum packaging unit in its original packaging without opening it. Do not deviate from the above temperature and humidity conditions even for a short term.</p> <p>3) Corrosive gasses in the air or atmosphere may result in deterioration of the reliability, such as poor solderability of the terminal electrodes. Do not store capacitors where they will be exposed to corrosive gas (e.g., hydrogen sulfide, sulfur dioxide, chlorine ammonia etc.)</p> <p>4) Solderability and electrical performance may deteriorate due to photochemical change in the terminal electrode if stored in direct sunlight, or due to condensation from rapid changes in humidity. The capacitors especially which use resin material must be operated and stored in an environment free of dew condensation, as moisture absorption due to condensation may affect the performance.</p> <p>5) Refer to JIS C 60721-3-1, class 1K2 for other climate conditions.</p> <p>1-2. Handling in transportation In case of the transportation of the capacitors, the performance of the capacitors may be deteriorated depending on the transportation condition. (Refer to JEITA RCR-2335C 9.2 Handling in transportation)</p>
2	Circuit design  Caution	<p>2-1. Operating temperature</p> <p>1) Upper category temperature (maximum operating temperature) is specified. It is necessary to select a capacitor whose rated temperature is higher than the operating temperature. Also, it is necessary to consider the temperature distribution in the equipment and seasonal temperature variation.</p> <p>2) Surface temperature including self heating should be below maximum operating temperature. Due to dielectric loss, capacitors will heat itself when AC is applied due to ESR. Especially at high frequencies, please be careful that the heat might be so extreme. Also, even if the surface temperature of the capacitor includes self-heating and is the maximum operating temperature or lower, excessive heating of the capacitor due to self-heating may cause deterioration of the characteristics and reliability of the capacitor. The self-heating temperature rise of the capacitor changes depending on the difference in heat radiation due to the mounting method to the device, the ambient temperature, the cooling method of the device and circuit board material and the design, etc. The load should be contained so that the self-heating temperature rise of the capacitor body in a natural convection environment at an ambient temperature of 25°C remain below 20°C. When using in a high-frequency circuit or a circuit in which a capacitor generates heat, such as when a high-frequency ripple current flows, pay attention to the above precautions. (Note that accurate measurement may not be possible with self-heating measurement when the equipment applies cooling other than natural convection such as a cooling fan.)</p> <p>3) The electrical characteristics of the capacitors will vary depending on the temperature. The capacitors should be selected and designed in taking the temperature into consideration.</p>

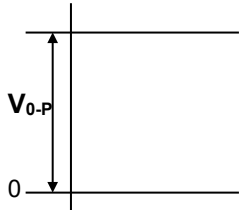
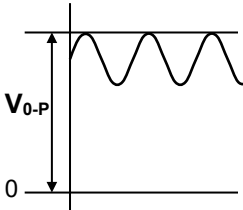
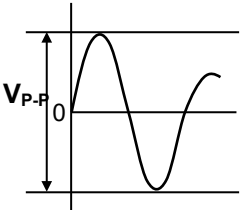
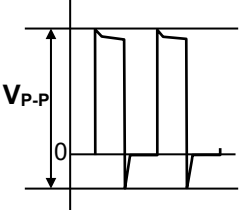
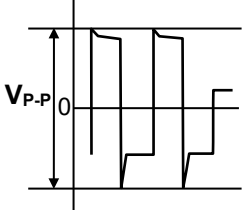
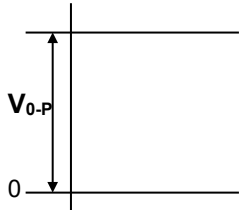
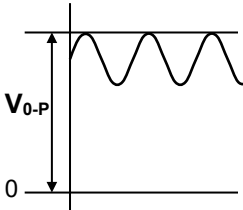
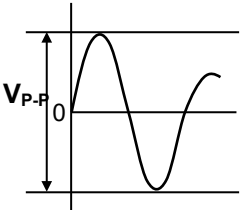
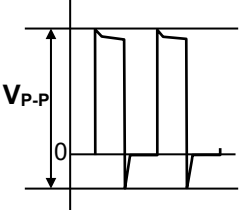
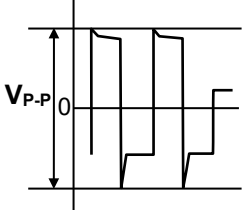
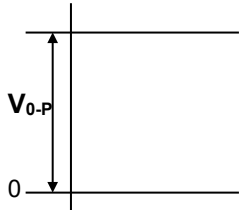
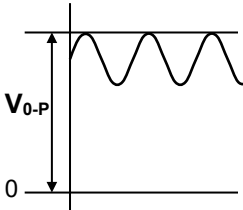
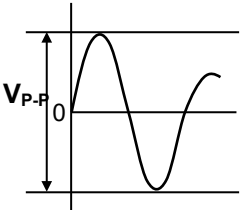
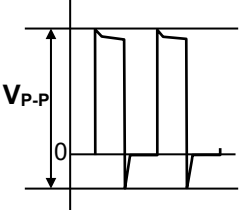
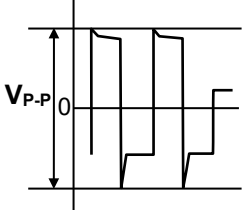
No.	Process	Condition														
2	Circuit design  Caution	<p>2-2. When overvoltage is applied Applying overvoltage to a capacitor may cause dielectric breakdown and result in a short circuit. The duration until dielectric breakdown depends on the applied voltage and the ambient temperature.</p> <p>2-3. Operating voltage 1) Operating voltage across the terminals should be below the rated voltage. When AC and DC are super imposed, V_{0-P} must be below the rated voltage. — (1) and (2) AC or pulse with overshooting, V_{P-P} must be below the rated voltage. — (3), (4) and (5)</p> <p>When the voltage is started to apply to the circuit or it is stopped applying, the irregular voltage may be generated for a transit period because of resonance or switching. Be sure to use the capacitors within rated voltage containing these Irregular voltage.</p> <table border="1" data-bbox="485 663 1465 931"> <thead> <tr> <th data-bbox="485 663 679 701">Voltage</th> <th data-bbox="679 663 938 701">(1) DC voltage</th> <th data-bbox="938 663 1201 701">(2) DC+AC voltage</th> <th data-bbox="1201 663 1465 701">(3) AC voltage</th> </tr> </thead> <tbody> <tr> <td data-bbox="485 701 679 931">Positional Measurement (Rated voltage)</td> <td data-bbox="679 701 938 931">  </td> <td data-bbox="938 701 1201 931">  </td> <td data-bbox="1201 701 1465 931">  </td> </tr> </tbody> </table> <table border="1" data-bbox="485 965 1201 1234"> <thead> <tr> <th data-bbox="485 965 679 1003">Voltage</th> <th data-bbox="679 965 938 1003">(4) Pulse voltage (A)</th> <th data-bbox="938 965 1201 1003">(5) Pulse voltage (B)</th> </tr> </thead> <tbody> <tr> <td data-bbox="485 1003 679 1234">Positional Measurement (Rated voltage)</td> <td data-bbox="679 1003 938 1234">  </td> <td data-bbox="938 1003 1201 1234">  </td> </tr> </tbody> </table> <p>2) Even below the rated voltage, if repetitive high frequency AC or pulse is applied, the reliability of the capacitors may be reduced.</p> <p>3) The effective capacitance will vary depending on applied DC and AC voltages. The capacitors should be selected and designed in taking the voltages into consideration.</p> <p>4) Abnormal voltage (surge voltage, static electricity, pulse voltage, etc.) shall not exceed the rated voltage.</p> <p>5) When capacitors are used in a series connection, it is necessary to add a balancing circuit such as voltage dividing resistors in order to avoid an imbalance in the voltage applied to each capacitor.</p> <p>2-4. Frequency When the capacitors (Class 2) are used in AC and/or pulse voltages, the capacitors may vibrate themselves and generate audible sound.</p>	Voltage	(1) DC voltage	(2) DC+AC voltage	(3) AC voltage	Positional Measurement (Rated voltage)				Voltage	(4) Pulse voltage (A)	(5) Pulse voltage (B)	Positional Measurement (Rated voltage)		
Voltage	(1) DC voltage	(2) DC+AC voltage	(3) AC voltage													
Positional Measurement (Rated voltage)																
Voltage	(4) Pulse voltage (A)	(5) Pulse voltage (B)														
Positional Measurement (Rated voltage)																

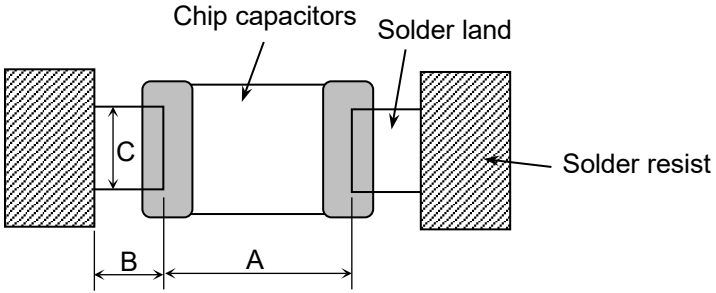
No.	Process	Condition																																																																																																
3	Designing P.C.board	<p>The amount of solder at the terminations has a direct effect on the reliability of the capacitors.</p> <ol style="list-style-type: none"> 1) The greater the amount of solder, the higher the stress on the chip capacitors, and the more likely that it will break. When designing a P.C.board, determine the shape and size of the solder lands to have proper amount of solder on the terminations. 2) Avoid using common solder land for multiple terminations and provide individual solder land for each terminations. 3) Size and recommended land dimensions. <div style="text-align: center;">  </div> <table border="1" style="width: 100%; border-collapse: collapse;"> <thead> <tr> <th colspan="5" style="text-align: left;">Reflow soldering</th> <th style="text-align: right;">(Unit : mm)</th> </tr> <tr> <th style="text-align: center;">Case size</th> <th style="text-align: center;">C1005</th> <th style="text-align: center;">C1608</th> <th style="text-align: center;">C2012</th> <th style="text-align: center;">C3216</th> <th></th> </tr> <tr> <th style="text-align: center;">Symbol</th> <th style="text-align: center;">[CC0402]</th> <th style="text-align: center;">[CC0603]</th> <th style="text-align: center;">[CC0805]</th> <th style="text-align: center;">[CC1206]</th> <th></th> </tr> </thead> <tbody> <tr> <td style="text-align: center;">A</td> <td style="text-align: center;">0.3 ~ 0.5</td> <td style="text-align: center;">0.6 ~ 0.8</td> <td style="text-align: center;">0.9 ~ 1.2</td> <td style="text-align: center;">2.0 ~ 2.4</td> <td></td> </tr> <tr> <td style="text-align: center;">B</td> <td style="text-align: center;">0.35 ~ 0.45</td> <td style="text-align: center;">0.6 ~ 0.8</td> <td style="text-align: center;">0.7 ~ 0.9</td> <td style="text-align: center;">1.0 ~ 1.2</td> <td></td> </tr> <tr> <td style="text-align: center;">C</td> <td style="text-align: center;">0.4 ~ 0.6</td> <td style="text-align: center;">0.6 ~ 0.8</td> <td style="text-align: center;">0.9 ~ 1.2</td> <td style="text-align: center;">1.1 ~ 1.6</td> <td></td> </tr> </tbody> </table> <table border="1" style="width: 100%; border-collapse: collapse;"> <thead> <tr> <th style="text-align: center;">Case size</th> <th style="text-align: center;">C3225</th> <th style="text-align: center;">C4532</th> <th style="text-align: center;">C5750</th> <th style="text-align: center;">C7563</th> <th></th> </tr> <tr> <th style="text-align: center;">Symbol</th> <th style="text-align: center;">[CC1210]</th> <th style="text-align: center;">[CC1812]</th> <th style="text-align: center;">[CC2220]</th> <th style="text-align: center;">[CC3025]</th> <th></th> </tr> </thead> <tbody> <tr> <td style="text-align: center;">A</td> <td style="text-align: center;">2.0 ~ 2.4</td> <td style="text-align: center;">3.1 ~ 3.7</td> <td style="text-align: center;">4.1 ~ 4.8</td> <td style="text-align: center;">5.2 ~ 5.8</td> <td></td> </tr> <tr> <td style="text-align: center;">B</td> <td style="text-align: center;">1.0 ~ 1.2</td> <td style="text-align: center;">1.2 ~ 1.4</td> <td style="text-align: center;">1.2 ~ 1.4</td> <td style="text-align: center;">1.7 ~ 1.9</td> <td></td> </tr> <tr> <td style="text-align: center;">C</td> <td style="text-align: center;">1.9 ~ 2.5</td> <td style="text-align: center;">2.4 ~ 3.2</td> <td style="text-align: center;">4.0 ~ 5.0</td> <td style="text-align: center;">6.4 ~ 7.4</td> <td></td> </tr> </tbody> </table> <table border="1" style="width: 100%; border-collapse: collapse;"> <thead> <tr> <th colspan="4" style="text-align: left;">Flow soldering (Unrecommend)</th> <th style="text-align: right;">(Unit : mm)</th> </tr> <tr> <th style="text-align: center;">Case size</th> <th style="text-align: center;">C1608</th> <th style="text-align: center;">C2012</th> <th style="text-align: center;">C3216</th> <th></th> </tr> <tr> <th style="text-align: center;">Symbol</th> <th style="text-align: center;">[CC0603]</th> <th style="text-align: center;">[CC0805]</th> <th style="text-align: center;">[CC1206]</th> <th></th> </tr> </thead> <tbody> <tr> <td style="text-align: center;">A</td> <td style="text-align: center;">0.7 ~ 1.0</td> <td style="text-align: center;">1.0 ~ 1.3</td> <td style="text-align: center;">2.1 ~ 2.5</td> <td></td> </tr> <tr> <td style="text-align: center;">B</td> <td style="text-align: center;">0.8 ~ 1.0</td> <td style="text-align: center;">1.0 ~ 1.2</td> <td style="text-align: center;">1.1 ~ 1.3</td> <td></td> </tr> <tr> <td style="text-align: center;">C</td> <td style="text-align: center;">0.6 ~ 0.8</td> <td style="text-align: center;">0.8 ~ 1.1</td> <td style="text-align: center;">1.0 ~ 1.3</td> <td></td> </tr> </tbody> </table>	Reflow soldering					(Unit : mm)	Case size	C1005	C1608	C2012	C3216		Symbol	[CC0402]	[CC0603]	[CC0805]	[CC1206]		A	0.3 ~ 0.5	0.6 ~ 0.8	0.9 ~ 1.2	2.0 ~ 2.4		B	0.35 ~ 0.45	0.6 ~ 0.8	0.7 ~ 0.9	1.0 ~ 1.2		C	0.4 ~ 0.6	0.6 ~ 0.8	0.9 ~ 1.2	1.1 ~ 1.6		Case size	C3225	C4532	C5750	C7563		Symbol	[CC1210]	[CC1812]	[CC2220]	[CC3025]		A	2.0 ~ 2.4	3.1 ~ 3.7	4.1 ~ 4.8	5.2 ~ 5.8		B	1.0 ~ 1.2	1.2 ~ 1.4	1.2 ~ 1.4	1.7 ~ 1.9		C	1.9 ~ 2.5	2.4 ~ 3.2	4.0 ~ 5.0	6.4 ~ 7.4		Flow soldering (Unrecommend)				(Unit : mm)	Case size	C1608	C2012	C3216		Symbol	[CC0603]	[CC0805]	[CC1206]		A	0.7 ~ 1.0	1.0 ~ 1.3	2.1 ~ 2.5		B	0.8 ~ 1.0	1.0 ~ 1.2	1.1 ~ 1.3		C	0.6 ~ 0.8	0.8 ~ 1.1	1.0 ~ 1.3	
Reflow soldering					(Unit : mm)																																																																																													
Case size	C1005	C1608	C2012	C3216																																																																																														
Symbol	[CC0402]	[CC0603]	[CC0805]	[CC1206]																																																																																														
A	0.3 ~ 0.5	0.6 ~ 0.8	0.9 ~ 1.2	2.0 ~ 2.4																																																																																														
B	0.35 ~ 0.45	0.6 ~ 0.8	0.7 ~ 0.9	1.0 ~ 1.2																																																																																														
C	0.4 ~ 0.6	0.6 ~ 0.8	0.9 ~ 1.2	1.1 ~ 1.6																																																																																														
Case size	C3225	C4532	C5750	C7563																																																																																														
Symbol	[CC1210]	[CC1812]	[CC2220]	[CC3025]																																																																																														
A	2.0 ~ 2.4	3.1 ~ 3.7	4.1 ~ 4.8	5.2 ~ 5.8																																																																																														
B	1.0 ~ 1.2	1.2 ~ 1.4	1.2 ~ 1.4	1.7 ~ 1.9																																																																																														
C	1.9 ~ 2.5	2.4 ~ 3.2	4.0 ~ 5.0	6.4 ~ 7.4																																																																																														
Flow soldering (Unrecommend)				(Unit : mm)																																																																																														
Case size	C1608	C2012	C3216																																																																																															
Symbol	[CC0603]	[CC0805]	[CC1206]																																																																																															
A	0.7 ~ 1.0	1.0 ~ 1.3	2.1 ~ 2.5																																																																																															
B	0.8 ~ 1.0	1.0 ~ 1.2	1.1 ~ 1.3																																																																																															
C	0.6 ~ 0.8	0.8 ~ 1.1	1.0 ~ 1.3																																																																																															

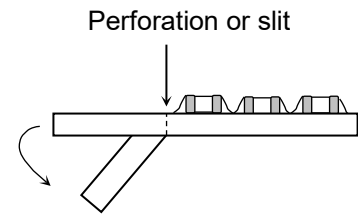
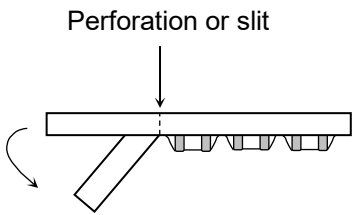
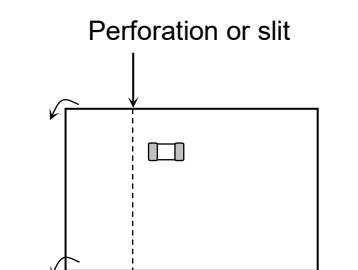
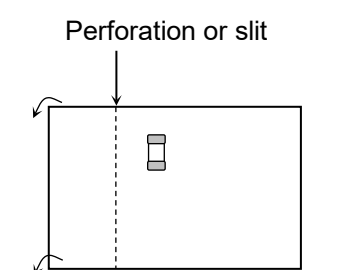
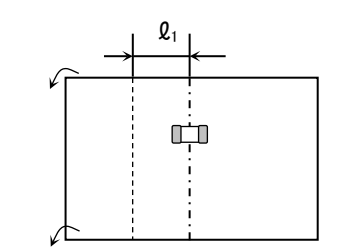
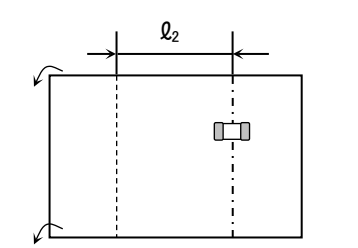
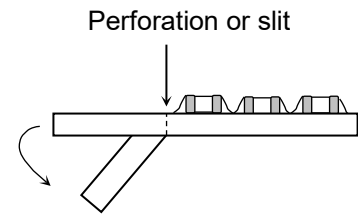
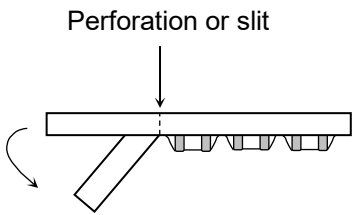
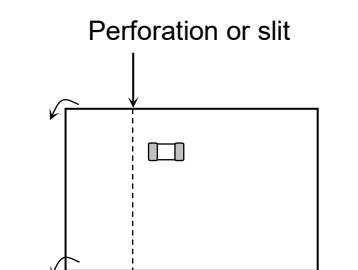
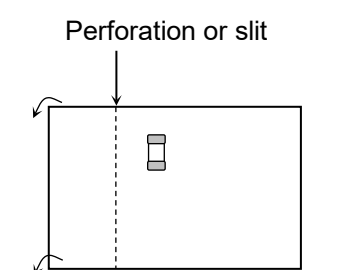
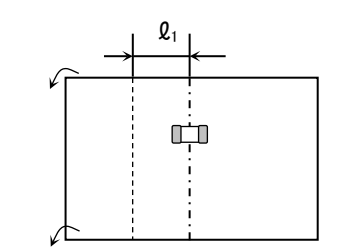
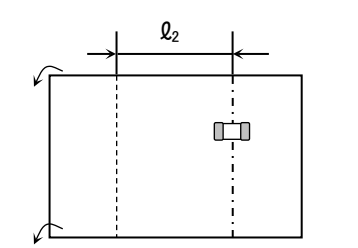
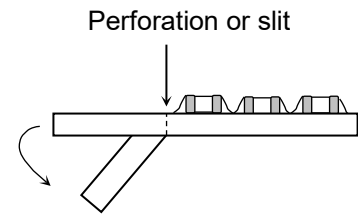
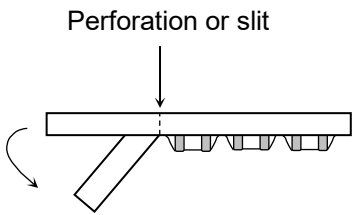
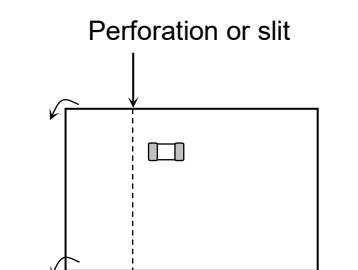
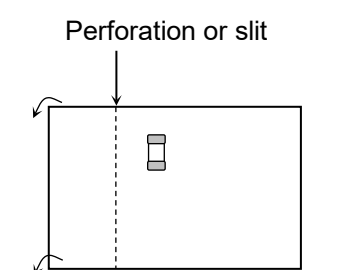
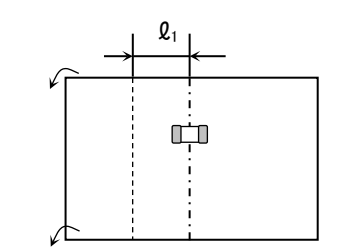
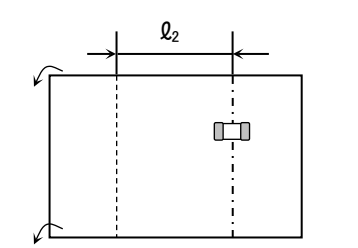
No.	Process	Condition												
3	Designing P.C.board	<p>4) Recommended chip capacitors layout is as following.</p> <table border="1" style="width: 100%; border-collapse: collapse;"> <thead> <tr> <th style="width: 20%;"></th> <th style="width: 40%;">Disadvantage against bending stress</th> <th style="width: 40%;">Advantage against bending stress</th> </tr> </thead> <tbody> <tr> <td style="text-align: center; vertical-align: middle;">Mounting face</td> <td style="text-align: center;"> <p>Perforation or slit</p>  <p>Break P.C.board with mounted side up.</p> </td> <td style="text-align: center;"> <p>Perforation or slit</p>  <p>Break P.C.board with mounted side down.</p> </td> </tr> <tr> <td style="text-align: center; vertical-align: middle;">Chip arrangement (Direction)</td> <td style="text-align: center;"> <p>Perforation or slit</p>  </td> <td style="text-align: center;"> <p>Perforation or slit</p>  </td> </tr> <tr> <td style="text-align: center; vertical-align: middle;">Distance from slit</td> <td style="text-align: center;"> <p>Closer to slit is higher stress</p>  <p>($l_1 < l_2$)</p> </td> <td style="text-align: center;"> <p>Away from slit is less stress</p>  <p>($l_1 < l_2$)</p> </td> </tr> </tbody> </table>		Disadvantage against bending stress	Advantage against bending stress	Mounting face	<p>Perforation or slit</p>  <p>Break P.C.board with mounted side up.</p>	<p>Perforation or slit</p>  <p>Break P.C.board with mounted side down.</p>	Chip arrangement (Direction)	<p>Perforation or slit</p> 	<p>Perforation or slit</p> 	Distance from slit	<p>Closer to slit is higher stress</p>  <p>($l_1 < l_2$)</p>	<p>Away from slit is less stress</p>  <p>($l_1 < l_2$)</p>
	Disadvantage against bending stress	Advantage against bending stress												
Mounting face	<p>Perforation or slit</p>  <p>Break P.C.board with mounted side up.</p>	<p>Perforation or slit</p>  <p>Break P.C.board with mounted side down.</p>												
Chip arrangement (Direction)	<p>Perforation or slit</p> 	<p>Perforation or slit</p> 												
Distance from slit	<p>Closer to slit is higher stress</p>  <p>($l_1 < l_2$)</p>	<p>Away from slit is less stress</p>  <p>($l_1 < l_2$)</p>												

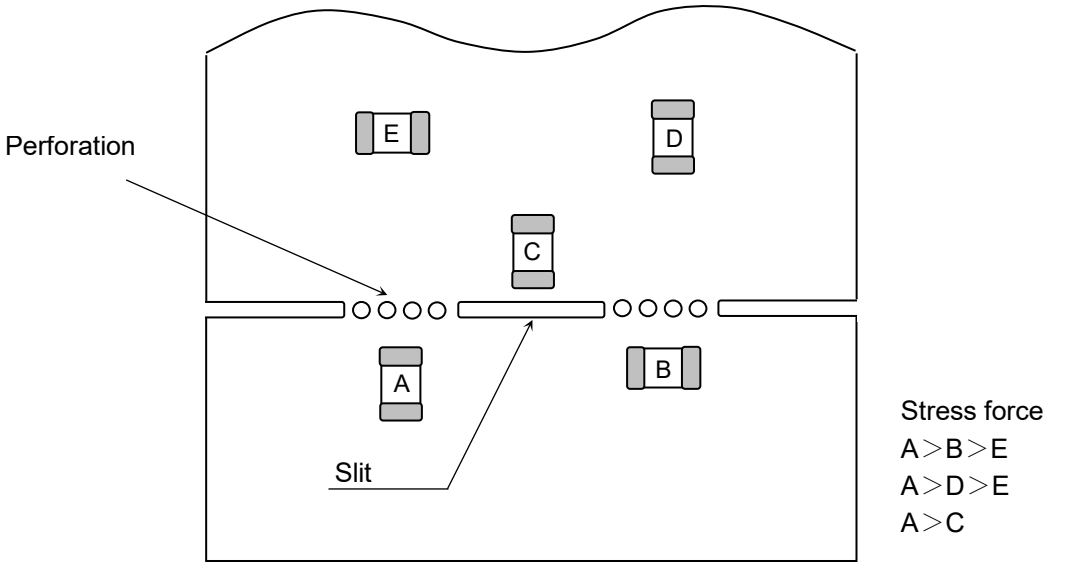
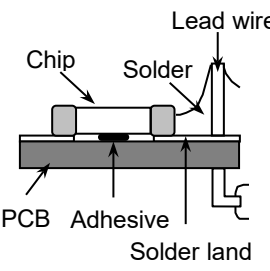
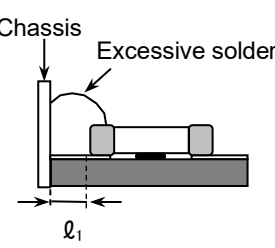
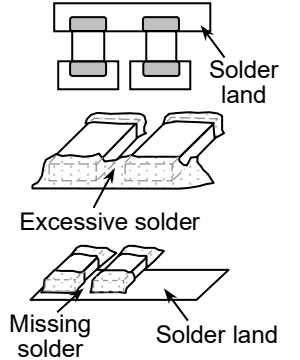
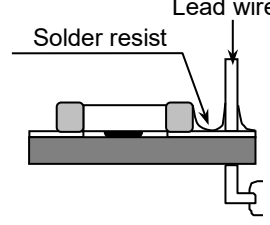
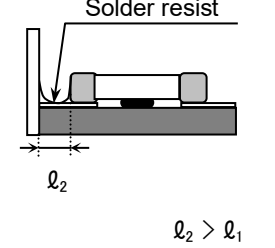
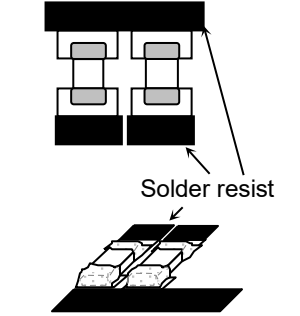
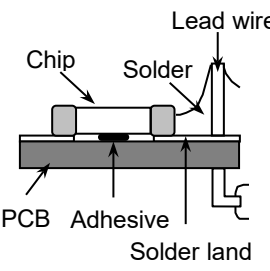
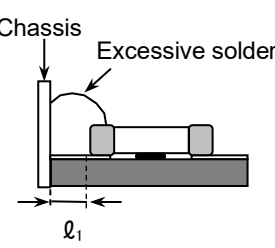
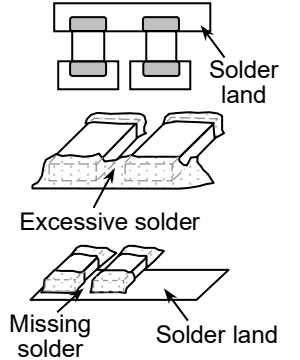
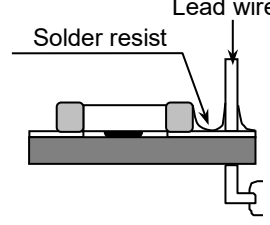
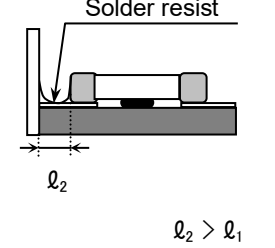
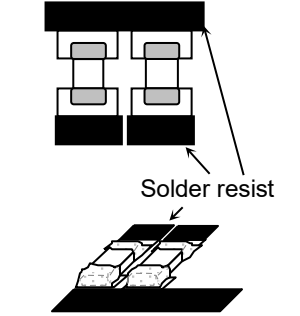
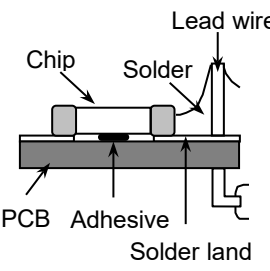
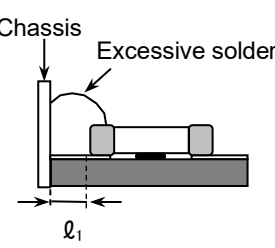
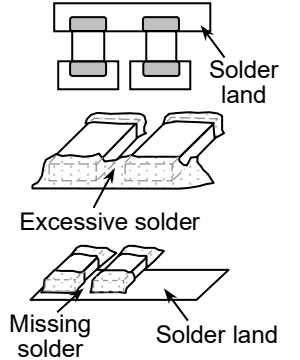
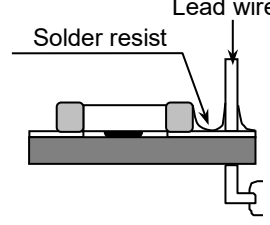
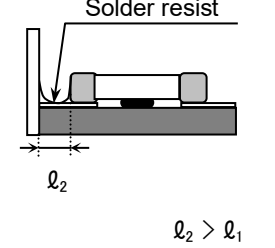
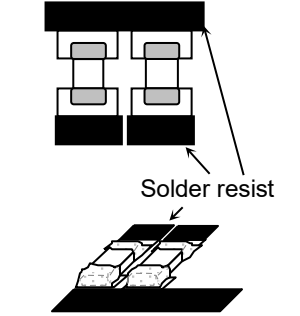
No.	Process	Condition												
3	Designing P.C.board	<p>5) Mechanical stress varies according to location of chip capacitors on the P.C.board.</p>  <p>When dividing printed wiring boards, the intensities of mechanical stress applied to capacitors are different according to each dividing method in the order of : Push-back < Slit < V-groove < Perforation. Therefore consider not only position of capacitors, but also the way of the dividing the printed wiring boards.</p> <p>6) Layout recommendation</p> <table border="1" data-bbox="395 1075 1497 1989"> <thead> <tr> <th data-bbox="395 1075 555 1187">Example</th> <th data-bbox="555 1075 858 1187">Use of common solder land</th> <th data-bbox="858 1075 1165 1187">Soldering with chassis</th> <th data-bbox="1165 1075 1497 1187">Use of common solder land with other SMD</th> </tr> </thead> <tbody> <tr> <td data-bbox="395 1187 555 1568">Need to avoid</td> <td data-bbox="555 1187 858 1568">  </td> <td data-bbox="858 1187 1165 1568">  </td> <td data-bbox="1165 1187 1497 1568">  </td> </tr> <tr> <td data-bbox="395 1568 555 1989">Recommendation</td> <td data-bbox="555 1568 858 1989">  </td> <td data-bbox="858 1568 1165 1989">  </td> <td data-bbox="1165 1568 1497 1989">  </td> </tr> </tbody> </table>	Example	Use of common solder land	Soldering with chassis	Use of common solder land with other SMD	Need to avoid				Recommendation			
Example	Use of common solder land	Soldering with chassis	Use of common solder land with other SMD											
Need to avoid														
Recommendation														

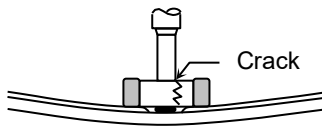
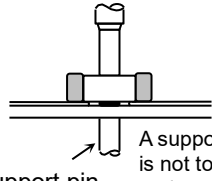
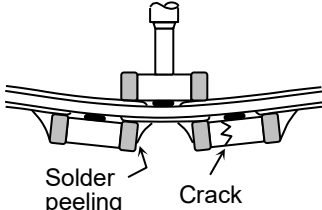
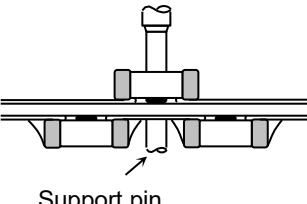
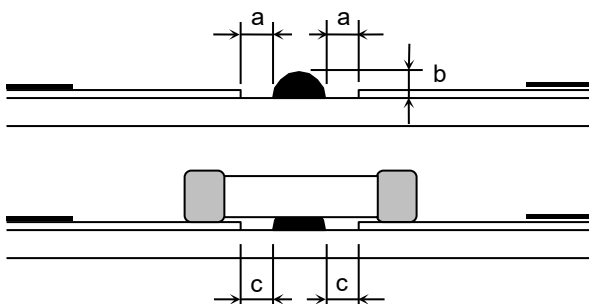
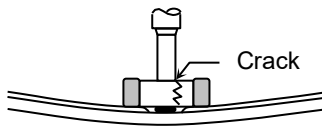
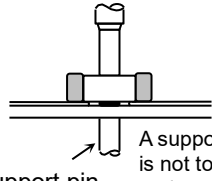
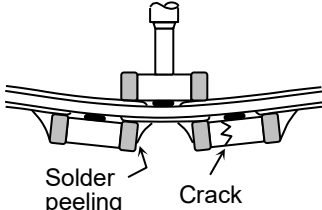
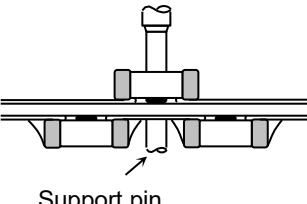
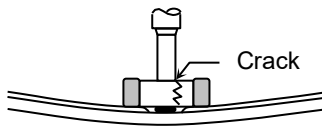
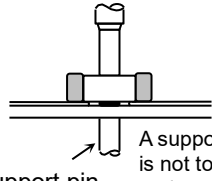
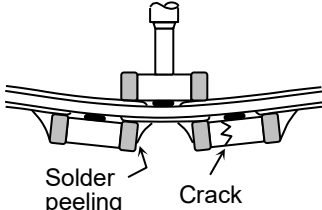
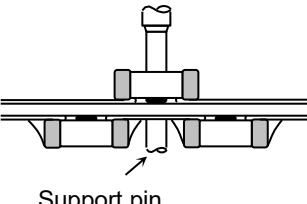
No.	Process	Condition															
4	Mounting	<p>4-1. Stress from mounting head</p> <p>If the mounting head is adjusted too low, it may induce excessive stress in the chip capacitors to result in cracking. Please take following precautions.</p> <ol style="list-style-type: none"> 1) Adjust the bottom dead center of the mounting head to reach on the P.C.board surface and not press it. 2) Adjust the mounting head pressure to be 1 to 3N of static weight. 3) To minimize the impact energy from mounting head, it is important to provide support from the bottom side of the P.C.board. <p>See following examples.</p> <table border="1" data-bbox="491 622 1445 1211"> <thead> <tr> <th></th> <th>Not recommended</th> <th>Recommended</th> </tr> </thead> <tbody> <tr> <td>Single-sided mounting</td> <td></td> <td> A support pin is not to be underneath the capacitor.</td> </tr> <tr> <td>Double-sides mounting</td> <td></td> <td></td> </tr> </tbody> </table> <p>When the centering jaw is worn out, it may give mechanical impact on the capacitors to cause crack. Please control the close up dimension of the centering jaw and provide sufficient preventive maintenance and replacement of it.</p> <p>4-2. Amount of adhesive</p>  <p>Example : C2012 [CC0805], C3216 [CC1206]</p> <table border="1" data-bbox="676 1778 1230 1944"> <tbody> <tr> <td>a</td> <td>0.2mm min.</td> </tr> <tr> <td>b</td> <td>70 ~ 100μm</td> </tr> <tr> <td>c</td> <td>Do not touch the solder land</td> </tr> </tbody> </table>		Not recommended	Recommended	Single-sided mounting		 A support pin is not to be underneath the capacitor.	Double-sides mounting			a	0.2mm min.	b	70 ~ 100μm	c	Do not touch the solder land
	Not recommended	Recommended															
Single-sided mounting		 A support pin is not to be underneath the capacitor.															
Double-sides mounting																	
a	0.2mm min.																
b	70 ~ 100μm																
c	Do not touch the solder land																

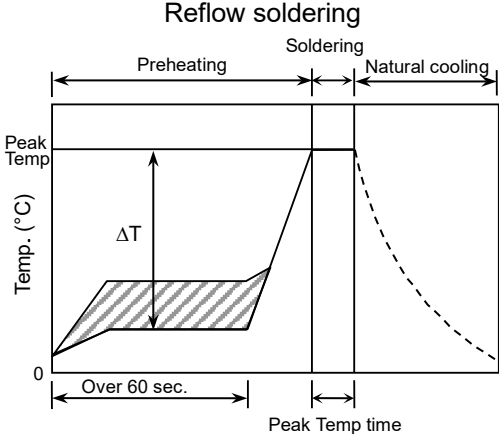
No.	Process	Condition														
5	Soldering	<p>5-1. Flux selection Flux can seriously affect the performance of capacitors. Confirm the following to select the appropriate flux.</p> <ol style="list-style-type: none"> 1) It is recommended to use a mildly activated rosin flux (less than 0.1wt% chlorine). Strong flux is not recommended. 2) Excessive flux must be avoided. Please provide proper amount of flux. 3) When water-soluble flux is used, enough washing is necessary. <p>5-2. Recommended soldering profile : Reflow method Refer to the following temperature profile at Reflow soldering.</p> <div style="text-align: center;"> <p>Reflow soldering</p>  </div> <p>Reflow soldering is recommended for C1608,C2012,C3216 types, but only reflow soldering is allowed for other case sizes.</p> <p>5-3. Recommended soldering peak temp and peak temp duration for Reflow soldering Pb free solder is recommended, but if Sn-37Pb must be used, refer to below.</p> <table border="1" data-bbox="496 1267 1289 1503"> <thead> <tr> <th rowspan="2" style="text-align: center;">Temp./Duration</th> <th colspan="2" style="text-align: center;">Reflow soldering</th> </tr> <tr> <th style="text-align: center;">Peak temp(°C)</th> <th style="text-align: center;">Duration(sec.)</th> </tr> </thead> <tbody> <tr> <td style="text-align: center;">Solder</td> <td></td> <td></td> </tr> <tr> <td style="text-align: center;">Lead Free Solder</td> <td style="text-align: center;">260 max.</td> <td style="text-align: center;">10 max.</td> </tr> <tr> <td style="text-align: center;">Sn-Pb Solder</td> <td style="text-align: center;">230 max.</td> <td style="text-align: center;">20 max.</td> </tr> </tbody> </table> <p>Recommended solder compositions Lead Free Solder : Sn-3.0Ag-0.5Cu</p>	Temp./Duration	Reflow soldering		Peak temp(°C)	Duration(sec.)	Solder			Lead Free Solder	260 max.	10 max.	Sn-Pb Solder	230 max.	20 max.
Temp./Duration	Reflow soldering															
	Peak temp(°C)	Duration(sec.)														
Solder																
Lead Free Solder	260 max.	10 max.														
Sn-Pb Solder	230 max.	20 max.														

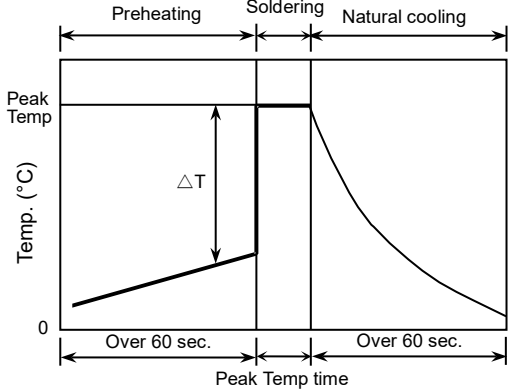
No.	Process	Condition																						
5	Soldering	<p data-bbox="437 215 1166 282">5-4. Soldering profile : Flow method (Unrecommend) Refer to the following temperature profile at Flow soldering.</p> <div data-bbox="651 300 1161 741" style="text-align: center;"> <p data-bbox="820 300 992 331">Flow soldering</p>  <p>The graph shows a temperature profile for flow soldering. The y-axis is labeled 'Temp. (°C)' and the x-axis is labeled 'Peak Temp time'. The profile is divided into three phases: 'Preheating', 'Soldering', and 'Natural cooling'. The 'Preheating' phase shows a linear increase in temperature from 0 to a peak level, with a time duration of 'Over 60 sec.' below the axis. The 'Soldering' phase is a horizontal line at the 'Peak Temp' level, also with a time duration of 'Over 60 sec.' below the axis. The 'Natural cooling' phase shows a curved decrease in temperature from the peak level back to 0. A vertical double-headed arrow labeled 'ΔT' indicates the temperature difference between the peak and the start of the soldering phase.</p> </div> <p data-bbox="461 768 1246 799">Reflow soldering is recommended for C1608,C2012,C3216 types.</p> <p data-bbox="437 840 1436 907">5-5. Recommended soldering peak temp and peak temp duration for Flow soldering Pb free solder is recommended, but if Sn-37Pb must be used, refer to below.</p> <table border="1" data-bbox="587 922 1332 1160"> <thead> <tr> <th data-bbox="587 922 837 1041" rowspan="2">Temp./Duration</th> <th colspan="2" data-bbox="837 922 1332 981">Flow soldering</th> </tr> <tr> <th data-bbox="837 981 1085 1041">Peak temp(°C)</th> <th data-bbox="1085 981 1332 1041">Duration(sec.)</th> </tr> </thead> <tbody> <tr> <td data-bbox="587 1041 837 1099">Lead Free Solder</td> <td data-bbox="837 1041 1085 1099">260 max.</td> <td data-bbox="1085 1041 1332 1099">5 max.</td> </tr> <tr> <td data-bbox="587 1099 837 1160">Sn-Pb Solder</td> <td data-bbox="837 1099 1085 1160">250 max.</td> <td data-bbox="1085 1099 1332 1160">3 max.</td> </tr> </tbody> </table> <p data-bbox="483 1169 922 1236">Recommended solder compositions Lead Free Solder : Sn-3.0Ag-0.5Cu</p> <p data-bbox="437 1270 770 1301">5-6. Avoiding thermal shock</p> <p data-bbox="437 1317 730 1348">1) Preheating condition</p> <table border="1" data-bbox="539 1348 1414 1585"> <thead> <tr> <th data-bbox="539 1348 762 1391">Soldering</th> <th data-bbox="762 1348 1204 1391">Case size</th> <th data-bbox="1204 1348 1414 1391">Temp. (°C)</th> </tr> </thead> <tbody> <tr> <td data-bbox="539 1391 762 1518" rowspan="2">Reflow soldering</td> <td data-bbox="762 1391 1204 1451">C1005[CC0402], C1608[CC0603], C2012[CC0805], C3216[CC1206]</td> <td data-bbox="1204 1391 1414 1451">$\Delta T \leq 150$</td> </tr> <tr> <td data-bbox="762 1451 1204 1518">C3225[CC1210], C4532[CC1812], C5750[CC2220], C7563[CC3025]</td> <td data-bbox="1204 1451 1414 1518">$\Delta T \leq 130$</td> </tr> <tr> <td data-bbox="539 1518 762 1585">Flow soldering</td> <td data-bbox="762 1518 1204 1585">C1608[CC0603], C2012[CC0805], C3216[CC1206]</td> <td data-bbox="1204 1518 1414 1585">$\Delta T \leq 150$</td> </tr> </tbody> </table> <p data-bbox="437 1619 699 1650">2) Cooling condition</p> <p data-bbox="483 1650 1461 1709">Natural cooling using air is recommended. If the chips are dipped into a solvent for cleaning, the temperature difference (ΔT) must be less than 100°C.</p>	Temp./Duration	Flow soldering		Peak temp(°C)	Duration(sec.)	Lead Free Solder	260 max.	5 max.	Sn-Pb Solder	250 max.	3 max.	Soldering	Case size	Temp. (°C)	Reflow soldering	C1005[CC0402], C1608[CC0603], C2012[CC0805], C3216[CC1206]	$\Delta T \leq 150$	C3225[CC1210], C4532[CC1812], C5750[CC2220], C7563[CC3025]	$\Delta T \leq 130$	Flow soldering	C1608[CC0603], C2012[CC0805], C3216[CC1206]	$\Delta T \leq 150$
Temp./Duration	Flow soldering																							
	Peak temp(°C)	Duration(sec.)																						
Lead Free Solder	260 max.	5 max.																						
Sn-Pb Solder	250 max.	3 max.																						
Soldering	Case size	Temp. (°C)																						
Reflow soldering	C1005[CC0402], C1608[CC0603], C2012[CC0805], C3216[CC1206]	$\Delta T \leq 150$																						
	C3225[CC1210], C4532[CC1812], C5750[CC2220], C7563[CC3025]	$\Delta T \leq 130$																						
Flow soldering	C1608[CC0603], C2012[CC0805], C3216[CC1206]	$\Delta T \leq 150$																						

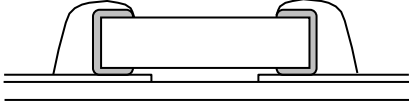
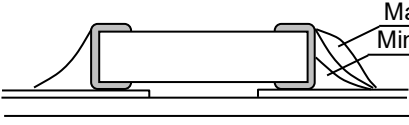
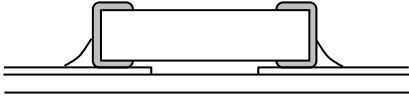
No.	Process	Condition
5	Soldering	<p data-bbox="438 264 699 293">5-7. Amount of solder</p> <p data-bbox="523 300 1465 387">Excessive solder will induce higher tensile force in chip capacitors when temperature changes and it may result in chip cracking. In sufficient solder may detach the capacitors from the P.C.board.</p> <hr/> <div data-bbox="496 443 619 510">Excessive solder</div> <div data-bbox="683 427 1093 528">  </div> <div data-bbox="1121 432 1414 521">Higher tensile force in chip capacitors to cause crack</div> <hr/> <div data-bbox="496 618 619 647">Adequate</div> <div data-bbox="683 568 1093 692">  </div> <div data-bbox="1062 568 1262 622">Maximum amount Minimum amount</div> <hr/> <div data-bbox="496 752 635 819">Insufficient solder</div> <div data-bbox="683 734 1093 835">  </div> <div data-bbox="1121 725 1414 837">Low robustness may cause contact failure or chip capacitors come off the P.C.board.</div> <hr/> <p data-bbox="438 913 651 943">5-8. Sn-Zn solder</p> <p data-bbox="464 949 1155 1005">Sn-Zn solder affects product reliability. Please contact TDK in advance when utilize Sn-Zn solder.</p> <p data-bbox="438 1043 863 1072">5-9. Countermeasure for tombstone</p> <p data-bbox="464 1079 1433 1263">The misalignment between the mounted positions of the capacitors and the land patterns should be minimized. The tombstone phenomenon may occur especially the capacitors are mounted (in longitudinal direction) in the same direction of the reflow soldering. (Refer to JEITA RCR-2335C Annex A (Informative) Recommendations to prevent the tombstone phenomenon)</p>

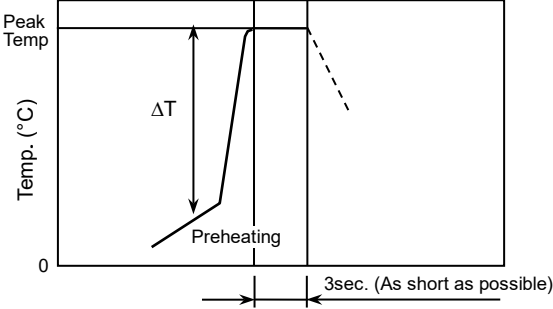
No.	Process	Condition																									
6	Solder repairing	<p>Solder repairing is unavoidable, refer to below.</p> <p>6-1. Solder repair by solder iron</p> <p>1) Selection of the soldering iron tip Tip temperature of solder iron varies by its type, P.C.board material and solder land size. The higher the tip temperature, the quicker the operation. However, heat shock may cause a crack in the chip capacitors. Please make sure the tip temp. before soldering and keep the peak temp and time in accordance with following recommended condition.</p> <div style="text-align: center;"> <p>Manual soldering (Solder iron)</p>  </div> <table border="1" style="margin: 10px auto; width: 80%; border-collapse: collapse;"> <thead> <tr> <th colspan="5" style="text-align: center;">Recommended solder iron condition (Sn-Pb Solder and Lead Free Solder)</th> </tr> <tr> <th style="width: 20%;">Case size</th> <th style="width: 15%;">Temp. (°C)</th> <th style="width: 15%;">Duration (sec.)</th> <th style="width: 15%;">Wattage (W)</th> <th style="width: 35%;">Shape (mm)</th> </tr> </thead> <tbody> <tr> <td>C1005[CC0402] C1608[CC0603] C2012[CC0805] C3216[CC1206]</td> <td style="text-align: center;">350 max.</td> <td rowspan="2" style="text-align: center;">3 max.</td> <td rowspan="2" style="text-align: center;">20 max.</td> <td rowspan="2" style="text-align: center;">ø3.0 max.</td> </tr> <tr> <td>C3225[CC1210] C4532[CC1812] C5750[CC2220] C7563[CC3025]</td> <td style="text-align: center;">280 max.</td> </tr> </tbody> </table> <p>* Please preheat the chip capacitors with the condition in 6-2 to avoid the thermal shock.</p> <p>2) Direct contact of the soldering iron with ceramic dielectric of chip capacitors may cause crack. Do not touch the ceramic dielectric and the terminations by solder iron.</p> <p>3) It is not recommended to reuse dismantled capacitors.</p> <p>6-2. Avoiding thermal shock</p> <p>Preheating condition</p> <table border="1" style="margin: 10px auto; width: 80%; border-collapse: collapse;"> <thead> <tr> <th style="width: 20%;">Soldering</th> <th style="width: 50%;">Case size</th> <th style="width: 30%;">Temp. (°C)</th> </tr> </thead> <tbody> <tr> <td rowspan="2" style="text-align: center;">Manual soldering</td> <td>C1005[CC0402], C1608[CC0603], C2012[CC0805], C3216[CC1206]</td> <td style="text-align: center;">$\Delta T \leq 150$</td> </tr> <tr> <td>C3225[CC1210], C4532[CC1812] C5750[CC2220], C7563[CC3025]</td> <td style="text-align: center;">$\Delta T \leq 130$</td> </tr> </tbody> </table>	Recommended solder iron condition (Sn-Pb Solder and Lead Free Solder)					Case size	Temp. (°C)	Duration (sec.)	Wattage (W)	Shape (mm)	C1005[CC0402] C1608[CC0603] C2012[CC0805] C3216[CC1206]	350 max.	3 max.	20 max.	ø3.0 max.	C3225[CC1210] C4532[CC1812] C5750[CC2220] C7563[CC3025]	280 max.	Soldering	Case size	Temp. (°C)	Manual soldering	C1005[CC0402], C1608[CC0603], C2012[CC0805], C3216[CC1206]	$\Delta T \leq 150$	C3225[CC1210], C4532[CC1812] C5750[CC2220], C7563[CC3025]	$\Delta T \leq 130$
Recommended solder iron condition (Sn-Pb Solder and Lead Free Solder)																											
Case size	Temp. (°C)	Duration (sec.)	Wattage (W)	Shape (mm)																							
C1005[CC0402] C1608[CC0603] C2012[CC0805] C3216[CC1206]	350 max.	3 max.	20 max.	ø3.0 max.																							
C3225[CC1210] C4532[CC1812] C5750[CC2220] C7563[CC3025]	280 max.																										
Soldering	Case size	Temp. (°C)																									
Manual soldering	C1005[CC0402], C1608[CC0603], C2012[CC0805], C3216[CC1206]	$\Delta T \leq 150$																									
	C3225[CC1210], C4532[CC1812] C5750[CC2220], C7563[CC3025]	$\Delta T \leq 130$																									

No.	Process	Condition
7	Cleaning	<p>1) If an unsuitable cleaning fluid is used, flux residue or some foreign articles may stick to chip capacitors surface to deteriorate especially the insulation resistance.</p> <p>2) If cleaning condition is not suitable, it may damage the chip capacitors.</p> <p>2)-1. Insufficient washing</p> <p>(1) Terminal electrodes may corrode by Halogen in the flux.</p> <p>(2) Halogen in the flux may adhere on the surface of capacitors, and lower the insulation resistance.</p> <p>(3) Water soluble flux has higher tendency to have above mentioned problems (1) and (2).</p> <p>2)-2. Excessive washing</p> <p>When ultrasonic cleaning is used, excessively high ultrasonic energy output can affect the connection between the ceramic chip capacitor's body and the terminal electrode. To avoid this, following is the recommended condition.</p> <p style="text-align: center;">Power : 20 W/ℓmax. Frequency : 40 kHz max. Washing time : 5 minutes max.</p> <p>2)-3. If the cleaning fluid is contaminated, density of Halogen increases, and it may bring the same result as insufficient cleaning.</p>

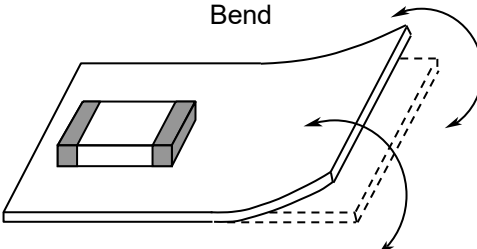
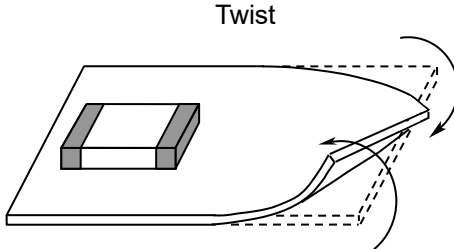
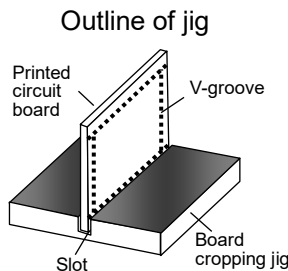
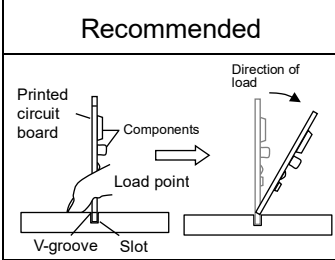
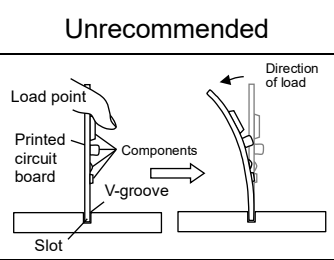
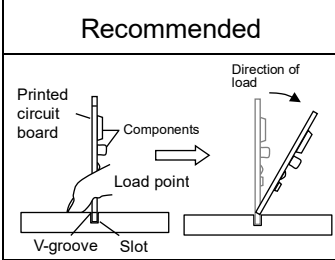
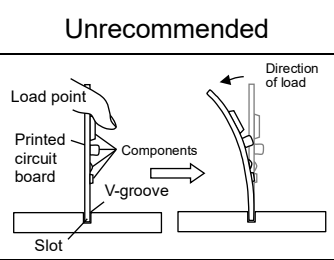
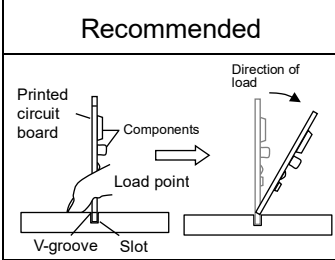
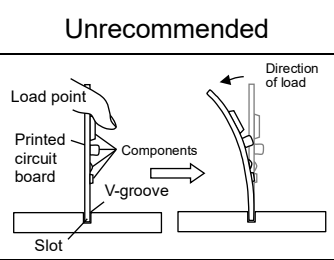
No.	Process	Condition				
8	Coating and molding of the P.C.board	<p>1) This product contains Ag (Silver) as part of the middle layer of termination. To avoid electromigration of Ag under high temperature and humidity, and failures caused by corrosive gas, chip capacitors on P.C boards should be protected by moisture proof-sealing.</p> <p>2) When the P.C.board is coated, please verify the quality influence on the product.</p> <p>3) Please verify carefully that there is no harmful decomposing or reaction gas emission during curing which may damage the chip capacitors.</p> <p>4) Please verify the curing temperature.</p>				
9	Handling after chip mounted  Caution	<p>1) Please pay attention not to bend or distort the P.C.board after soldering in handling otherwise the chip capacitors may crack.</p> <div style="display: flex; justify-content: space-around; align-items: center;"> <div style="text-align: center;">  <p>Bend</p> </div> <div style="text-align: center;">  <p>Twist</p> </div> </div> <p>2) Printed circuit board cropping should not be carried out by hand, but by using the proper tooling. Printed circuit board cropping should be carried out using a board cropping jig as shown in the following figure or a board cropping apparatus to prevent inducing mechanical stress on the board.</p> <p>(1) Example of a board cropping jig</p> <p>Recommended example: The board should be pushed from the back side, close to the cropping jig so that the board is not bent and the stress applied to the capacitor is compressive.</p> <p>Unrecommended example: If the pushing point is far from the cropping jig and the pushing direction is from the front side of the board, large tensile stress is applied to the capacitor, which may cause cracks.</p> <div style="display: flex; justify-content: space-around; align-items: center;"> <div style="text-align: center;">  <p>Outline of jig</p> </div> <table border="1" style="width: 100%; border-collapse: collapse;"> <thead> <tr> <th style="width: 50%; text-align: center;">Recommended</th> <th style="width: 50%; text-align: center;">Unrecommended</th> </tr> </thead> <tbody> <tr> <td style="text-align: center;">  </td> <td style="text-align: center;">  </td> </tr> </tbody> </table> </div>	Recommended	Unrecommended		
Recommended	Unrecommended					
						

No.	Process	Condition																		
9	Handling after chip mounted ⚠ Caution	<p>(2) Example of a board cropping machine</p> <p>An outline of a printed circuit board cropping machine is shown below. The top and bottom blades are aligned with one another along the lines with the V-grooves on printed circuit board when cropping the board.</p> <p>Unrecommended example: Misalignment of blade position between top and bottom, right and left, or front and rear blades may cause a crack in the capacitor.</p> <div style="display: flex; justify-content: space-around;"> <div data-bbox="566 517 981 772"> <p>Outline of machine</p> </div> <div data-bbox="973 517 1428 750"> <p>Principle of operation</p> </div> </div> <div style="text-align: center; margin-top: 10px;"> <p>Cross-section diagram</p> </div> <table border="1" style="width: 100%; text-align: center; margin-top: 20px;"> <thead> <tr> <th data-bbox="641 999 821 1048">Recommended</th> <th colspan="3" data-bbox="821 999 1353 1048">Unrecommended</th> </tr> <tr> <th></th> <th data-bbox="821 1048 1002 1131">Top-bottom misalignment</th> <th data-bbox="1002 1048 1166 1131">Left-right misalignment</th> <th data-bbox="1166 1048 1353 1131">Front-rear misalignment</th> </tr> </thead> <tbody> <tr> <td data-bbox="641 1086 821 1424"> </td> <td data-bbox="821 1086 1002 1424"> </td> <td data-bbox="1002 1086 1166 1424"> </td> <td data-bbox="1166 1086 1353 1424"> </td> </tr> </tbody> </table> <p>3) When functional check of the P.C. board is performed, check pin pressure tends to be adjusted higher for fear of loose contact. But if the pressure is excessive and bend the P.C. board, it may crack the chip capacitors or peel the terminations off. Please adjust the check pins not to bend the P.C. board.</p> <table border="1" style="width: 100%; text-align: center; margin-top: 20px;"> <thead> <tr> <th data-bbox="475 1671 616 1731">Item</th> <th data-bbox="616 1671 1034 1731">Not recommended</th> <th data-bbox="1034 1671 1430 1731">Recommended</th> </tr> </thead> <tbody> <tr> <td data-bbox="475 1731 616 1966">Board bending</td> <td data-bbox="616 1731 1034 1966"> </td> <td data-bbox="1034 1731 1430 1966"> </td> </tr> </tbody> </table>	Recommended	Unrecommended				Top-bottom misalignment	Left-right misalignment	Front-rear misalignment					Item	Not recommended	Recommended	Board bending		
Recommended	Unrecommended																			
	Top-bottom misalignment	Left-right misalignment	Front-rear misalignment																	
Item	Not recommended	Recommended																		
Board bending																				

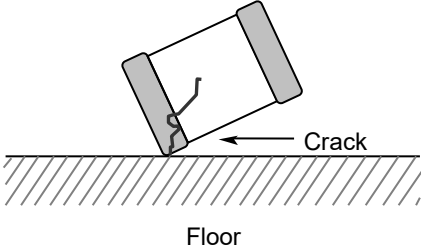
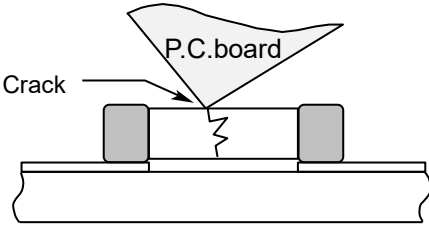
No.	Process	Condition
10	Handling of loose chip capacitors	<p>1) If dropped the chip capacitors may crack. Once dropped do not use it. Especially, the large case sized chip capacitors are tendency to have cracks easily, so please handle with care.</p>  <p>2) Piling the P.C.board after mounting for storage or handling, the corner of the P.C. board may hit the chip capacitors of another board to cause crack.</p> 
11	Capacitance aging	The capacitors (Class 2) have aging in the capacitance. They may not be used in precision time constant circuit. In case of the time constant circuit, the evaluation should be done well.
12	Estimated life and estimated failure rate of capacitors	As per the estimated life and the estimated failure rate depend on the temperature and the voltage. This can be calculated by the equation described in JEITA RCR-2335C Annex F (Informative) Calculation of the estimated lifetime and the estimated failure rate (Voltage acceleration coefficient : 3 multiplication rule, Temperature acceleration coefficient : 10°C rule) The failure rate can be decreased by reducing the temperature and the voltage but they will not be guaranteed.

No.	Process	Condition
13	Caution during operation of equipment	<p>1) A capacitor shall not be touched directly with bare hands during operation in order to avoid electric shock. Electric energy held by the capacitor may be discharged through the human body when touched with a bare hand. Even when the equipment is off, a capacitor may stay charged. The capacitor should be handled after being completely discharged using a resistor.</p> <p>2) The terminals of a capacitor shall not be short-circuited by any accidental contact with a conductive object. A capacitor shall not be exposed to a conductive liquid such as an acid or alkali solution. A conductive object or liquid, such as acid and alkali, between the terminals may lead to the breakdown of a capacitor due to short circuit</p> <p>3) Confirm that the environment to which the equipment will be exposed during transportation and operation meets the specified conditions. Do not to use the equipment in the following environments.</p> <p>(1) Environment where a capacitor is splattered with water or oil (2) Environment where a capacitor is exposed to direct sunlight (3) Environment where a capacitor is exposed to Ozone, ultraviolet rays or radiation (4) Environment where a capacitor exposed to corrosive gas(e.g. hydrogen sulfide, sulfur dioxide, chlorine. ammonia gas etc.) (5) Environment where a capacitor exposed to vibration or mechanical shock exceeding the specified limits. (6) Atmosphere change with causes condensation</p>
14	Others  Caution	<p>The products listed on this specification sheet are intended for use in general electronic equipment (AV equipment, telecommunications equipment, home appliances, amusement equipment, computer equipment, personal equipment, office equipment, measurement equipment, industrial robots) and automotive application under a normal operation and use condition.</p> <p>The products are not designed or warranted to meet the requirements of the applications listed below, whose performance and/or quality require a more stringent level of safety or reliability, or whose failure, malfunction or trouble could cause serious damage to society, person or property. Please understand that we are not responsible for any damage or liability caused by use of the products in any of the applications below or for any other use exceeding the range or conditions set forth in this specification sheet. If you intend to use the products in the applications listed below or if you have special requirements exceeding the range or conditions set forth in this specification, please contact us.</p> <p>(1) Aerospace/Aviation equipment (2) Transportation equipment (electric trains, ships, etc. except automotive application) (3) Medical equipment (Excepting Pharmaceutical Affairs Law classification Class1, 2) (4) Power-generation control equipment (5) Atomic energy-related equipment (6) Seabed equipment (7) Transportation control equipment (8) Public information-processing equipment (9) Military equipment (10) Electric heating apparatus, burning equipment (11) Disaster prevention/crime prevention equipment (12) Safety equipment (13) Other applications that are not considered general-purpose applications</p> <p>When designing your equipment even for general-purpose applications, you are kindly requested to take into consideration securing protection circuit/device or providing backup circuits in your equipment.</p>

14. TAPE PACKAGING SPECIFICATION

1. CONSTRUCTION AND DIMENSION OF TAPING

1-1. Dimensions of carrier tape

Dimensions of paper tape shall be according to Appendix 3, 4.

Dimensions of plastic tape shall be according to Appendix 5, 6.

1-2. Bulk part and leader of taping

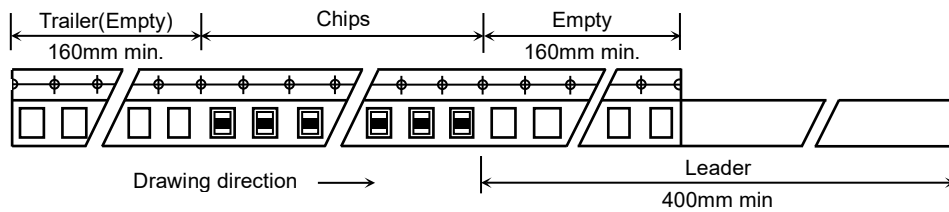

1-3. Dimensions of reel

Dimensions of $\varnothing 178$ reel shall be according to Appendix 7, 8.

Dimensions of $\varnothing 330$ reel shall be according to Appendix 9, 10.

1-4. Structure of taping

<Paper>

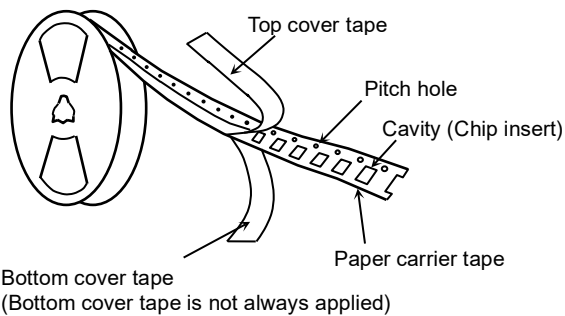

<Plastic>

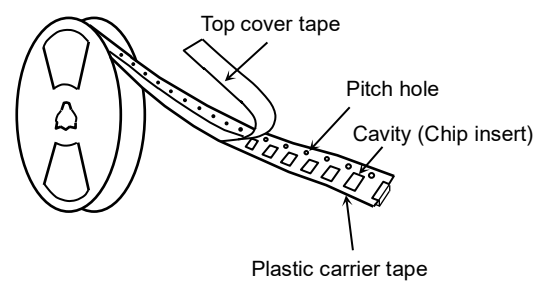

2. CHIP QUANTITY

Please refer to detail page on TDK web.

3. PERFORMANCE SPECIFICATIONS

3-1. Fixing peeling strength (top tape)

$$0.05\text{N} < \text{Peeling strength} < 0.7\text{N}$$

〈Paper〉

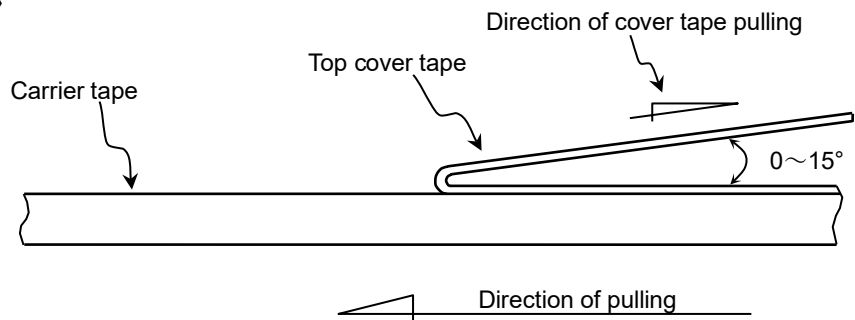

〔 Paper tape should not adhere to top cover tape when pull the cover tape. 〕

〈Plastic〉

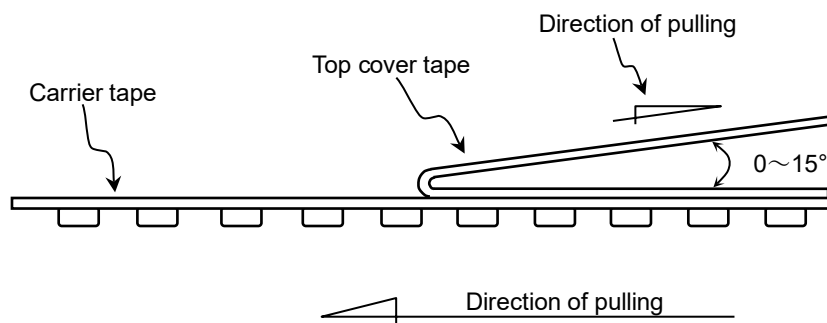

3-2. Carrier tape shall be flexible enough to be wound around a minimum radius of 30mm with components in tape.

3-3. The missing of components shall be less than 0.1%

3-4. Components shall not stick to fixing tape.

3-5. When removing the cover tape, there shall not be difficulties by unfitting clearance gap, burrs and crushes of cavities. Also the sprocket holes shall not be covered by absorbing dust into the suction nozzle.

Appendix 3

Paper Tape

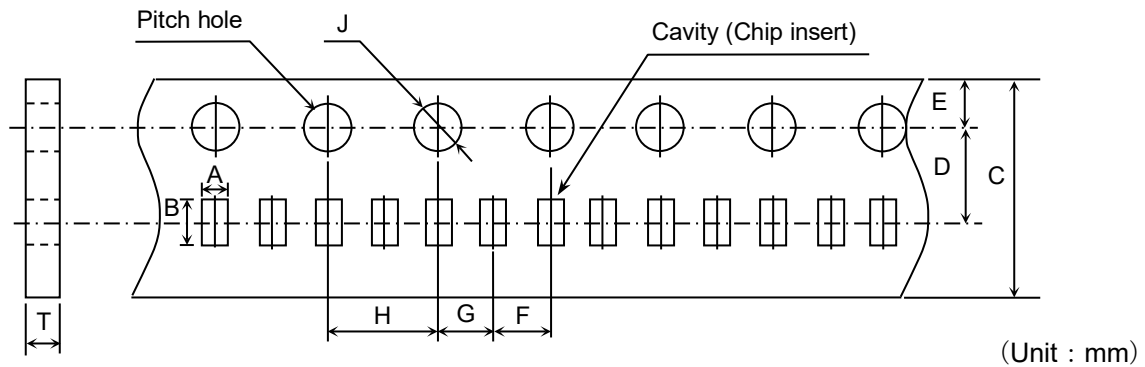

(Unit : mm)

Symbol	A	B	C	D	E	F
Case size						
C1005 [CC0402]	(0.65)	(1.15)	8.00 ± 0.30	3.50 ± 0.05	1.75 ± 0.10	2.00 ± 0.05

Symbol	G	H	J	T
Case size				
C1005 [CC0402]	2.00 ± 0.05	4.00 ± 0.10	$\varnothing 1.50 \begin{smallmatrix} +0.10 \\ 0 \end{smallmatrix}$	0.75 max.

() Reference value.

* Applied to thickness, 0.50 +0.20,-0.10mm products.

Appendix 4

Paper Tape

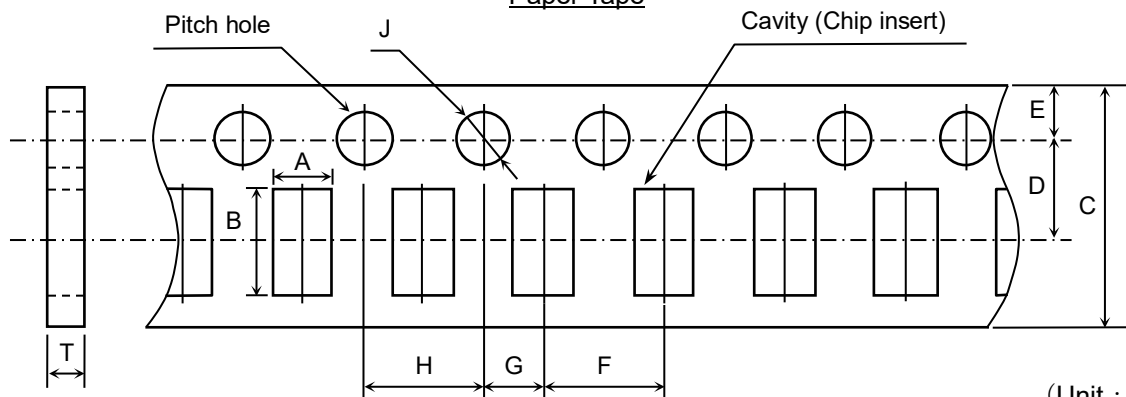

(Unit : mm)

Symbol	A	B	C	D	E	F
Case size						
C1608 [CC0603]	(1.10)	(1.90)	8.00 ± 0.30	3.50 ± 0.05	1.75 ± 0.10	4.00 ± 0.10
C2012 [CC0805]	(1.50)	(2.30)				
C3216 [CC1206]	(1.90)	(3.50)				

Symbol	G	H	J	T
Case size				
C1608 [CC0603]	2.00 ± 0.05	4.00 ± 0.10	$\varnothing 1.50 \begin{smallmatrix} +0.10 \\ 0 \end{smallmatrix}$	1.20 max.
C2012 [CC0805]				
C3216 [CC1206]				

() Reference value.

Appendix 5

Plastic Tape

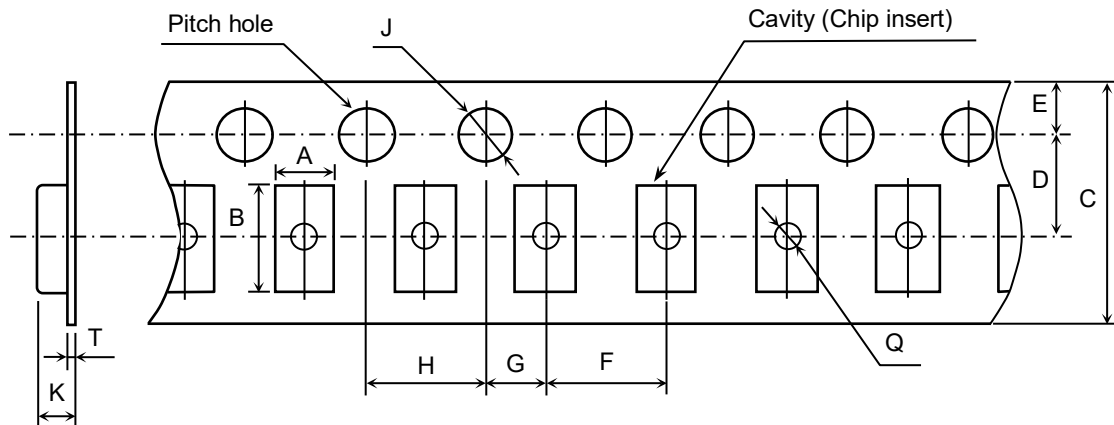

(Unit : mm)

Symbol	A	B	C	D	E	F
Case size						
C2012 [CC0805]	(1.50)	(2.30)	8.00 ± 0.30	3.50 ± 0.05	1.75 ± 0.10	4.00 ± 0.10
C3216 [CC1206]	(1.90)	(3.50)				
C3225 [CC1210]	(2.90)	(3.60)	8.00 ± 0.30 or 12.00 ± 0.30	3.50 ± 0.05 or 5.50 ± 0.05		
Symbol	G	H	J	K	T	Q
Type						
C2012 [CC0805]	2.00 ± 0.05	4.00 ± 0.10	ø1.50 $\begin{matrix} +0.10 \\ 0 \end{matrix}$	2.50 max.	0.60 max.	ø0.50 min.
C3216 [CC1206]						
C3225 [CC1210]				3.40 max.		

() Reference value.

Exceptionally no hole in the cavity is applied. Please inquire if hole in cavity is mandatory.

Appendix 6

Plastic Tape

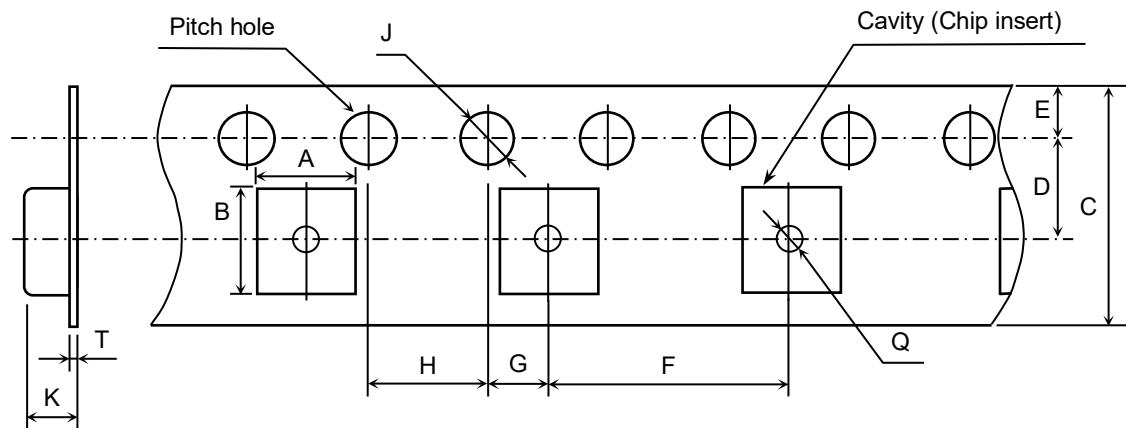

(Unit : mm)

Symbol Case size	A	B	C	D	E	F
C4532 [CC1812]	(3.60)	(4.90)	12.00 ± 0.30	5.50 ± 0.05	1.75 ± 0.10	8.00 ± 0.10
C5750 [CC2220]	(5.40)	(6.10)				
C7563 [CC3025]	(6.90)	(8.00)	16.00 ± 0.30	7.50 ± 0.05		12.00 ± 0.10
Symbol Case size	G	H	J	K	T	Q
C4532 [CC1812]	2.00 ± 0.05	4.00 ± 0.10	∅1.50 $\begin{matrix} +0.10 \\ 0 \end{matrix}$	6.50 max.	0.60 max.	∅1.50 min.
C5750 [CC2220]				5.00 max.		
C7563 [CC3025]	2.00 ± 0.10			—		

() Reference value.

Exceptionally no hole in the cavity is applied. Please inquire if hole in cavity is mandatory.

Appendix 7

Dimensions of reel (Material : Polystyrene)

C1005, C1608, C2012, C3216, C3225(8mm width taping type)

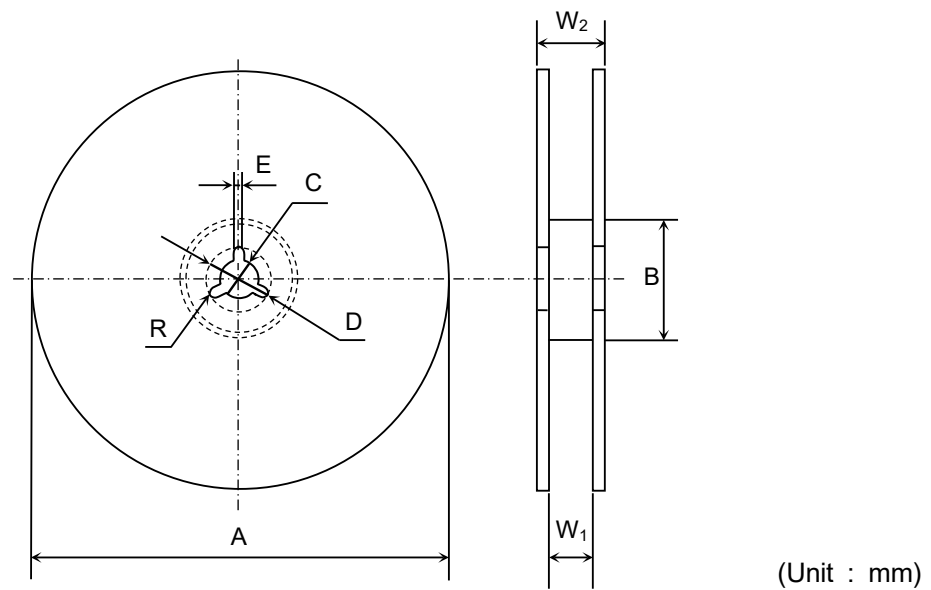

(Unit : mm)

Symbol	A	B	C	D	E	W ₁
Dimension	$\phi 178 \pm 2.0$	$\phi 60 \pm 2.0$	$\phi 13 \pm 0.5$	$\phi 21 \pm 0.8$	2.0 ± 0.5	9.0 ± 0.3
Symbol	W ₂	R				
Dimension	13.0 ± 1.4	1.0				

Appendix 8

Dimensions of reel (Material : Polystyrene)

C3225(12mm width taping type), C4532, C5750

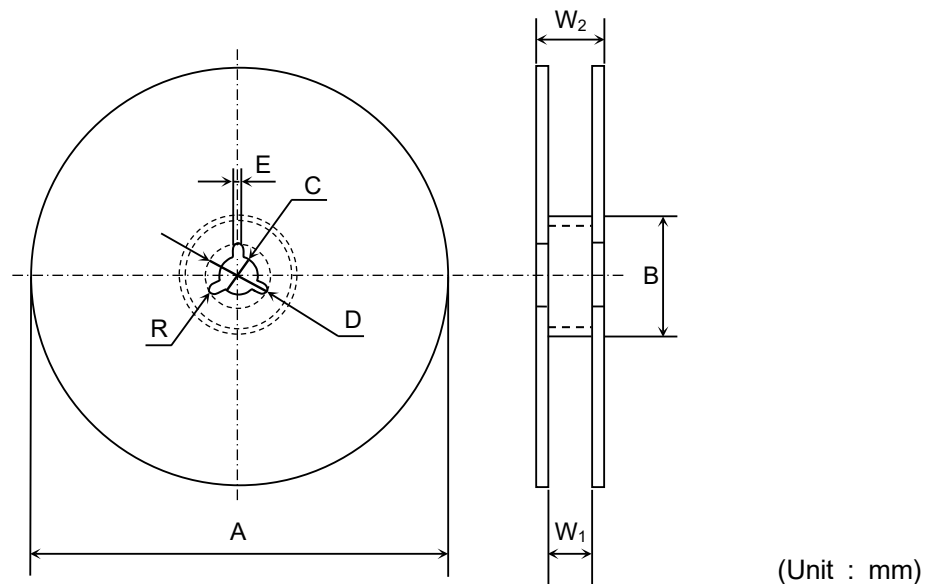

(Unit : mm)

Symbol	A	B	C	D	E	W ₁
Dimension	$\phi 178 \pm 2.0$	$\phi 60 \pm 2.0$	$\phi 13 \pm 0.5$	$\phi 21 \pm 0.8$	2.0 ± 0.5	13.0 ± 0.3
Symbol	W ₂	R				
Dimension	17.0 ± 1.4	1.0				

Appendix 9

Dimensions of reel (Material : Polystyrene)
C1005, C1608, C2012, C3216, C3225(8mm width taping type)

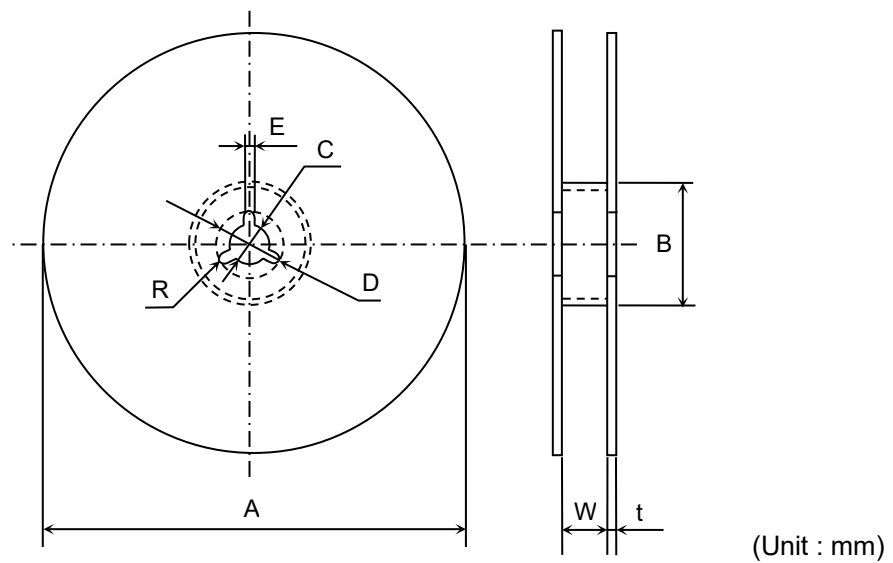

Symbol	A	B	C	D	E	W
Dimension	ø382 max. (Nominal ø330)	ø50 min.	ø13 ± 0.5	ø21 ± 0.8	2.0 ± 0.5	10.0 ± 1.5
Symbol	t	R				
Dimension	2.0 ± 0.5	1.0				

Appendix 10

Dimensions of reel (Material : Polystyrene)
C3225(12mm width taping type), C4532, C5750, C7563

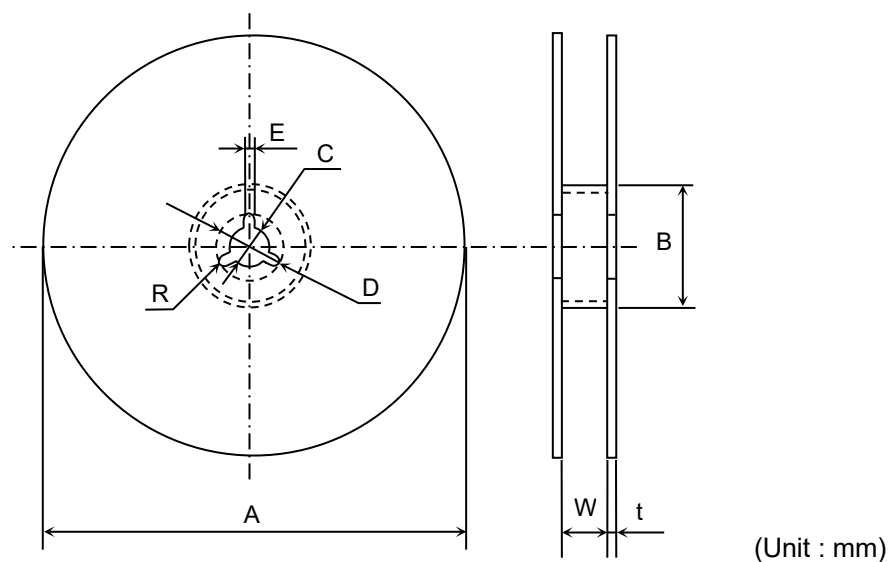

Symbol	A	B	C	D	E	W
Dimension	ø382 max. (Nominal ø330)	ø50 min.	ø13 ± 0.5	ø21 ± 0.8	2.0 ± 0.5	14.0 ± 1.5 *17.5 ± 1.5
Symbol	t	R				
Dimension	2.0 ± 0.5	1.0				

* Applied to C7563.