

RWS150B

EVALUATION DATA

型式データ

INDEX

1. 測定方法	Evaluation Method	PAGE
1.1	測定回路 Circuit used for determination	
	測定回路1 Circuit 1 used for determination	T-1
	静特性 Steady state data	
	通電ドリフト特性 Warm up voltage drift characteristics	
	出力保持時間特性 Hold up time characteristics	
	出力立ち上がり特性 Output rise characteristics	
	出力立ち下がり特性 Output fall characteristics	
	過電流保護特性 Over current protection (OCP) characteristics	
	過電圧保護特性 Over voltage protection (OVP) characteristics	
	入力電圧瞬停特性 Response to brown out characteristics	
	入力電流波形 Input current waveform	
	測定回路2 Circuit 2 used for determination	T-1
	過渡応答（負荷急変）特性 Dynamic load response characteristics	
	測定回路3 Circuit 3 used for determination	T-2
	入力サージ電流（突入電流）波形 Inrush current waveform	
	測定回路4 Circuit 4 used for determination	T-2
	リーク電流特性 Leakage current characteristics	
	測定回路5 Circuit 5 used for determination	T-3
	出力リップル、ノイズ波形 Output ripple and noise waveform	
	測定構成 Configuration used for determination	T-3
	EMI特性 Electro-Magnetic Interference characteristics	
	(a) 雑音端子電圧 (帰還ノイズ) Conducted Emission	
	(b) 雑音電界強度 (放射ノイズ) Radiated Emission	
1.2	使用測定機器 List of equipment used	T-4
1.3	評価負荷条件 Load conditions	T-4

2. 特性データ Characteristics

2.1 静特性 Steady state data

(1) 入力・負荷・温度変動／出力起動・遮断電圧

Regulation - line and load, Temperature drift / Start up voltage and Drop out voltage T-5

(2) リップルノイズ電圧対入力電圧

Ripple noise voltage vs. Input voltage T-6

(3) 効率・力率対出力電流 Efficiency and Power factor vs. Output current T-7

(4) 入力電力対出力電流 Input power vs. Output current T-8

(5) 入力電流対出力電流 Input current vs. Output current T-9

2.2 通電ドリフト特性 Warm up voltage drift characteristics T-10

2.3 出力保持時間特性 Hold up time characteristics T-10

2.4 出力立ち上がり特性 Output rise characteristics T-11

2.5 出力立ち下がり特性 Output fall characteristics T-12

2.6 過電流保護特性 Over current protection (OCP) characteristics T-13

2.7 過電圧保護特性 Over voltage protection (OVP) characteristics T-13

2.8 過渡応答（負荷急変）特性 Dynamic load response characteristics T-14

2.9 入力電圧瞬停特性 Response to brown out characteristics T-15

2.10 入力サージ電流（突入電流）波形 Inrush current waveform T-16

2.11 高調波成分 Input current harmonics T-17

2.12 入力電流波形 Input current waveform T-17

2.13 リーク電流特性 Leakage current characteristics T-18

2.14 出力リップル、ノイズ波形 Output ripple and noise waveform T-19

2.15 EMI特性 Electro-Magnetic Interference characteristics T-20～23

使用記号 Terminology used

	定義	Definition
Vin	入力電圧 Input voltage
Vout	出力電圧 Output voltage
Iin	入力電流 Input current
Iout	出力電流 Output current
Ta	周囲温度 Ambient temperature
f	周波数 Frequency

1. 測定方法 Evaluation Method

1.1 測定回路 Circuit used for determination

測定回路1 Circuit 1 used for determination

- 静特性 Steady state data
- 通電ドリフト特性 Warm up voltage drift characteristics
- 出力保持時間特性 Hold up time characteristics
- 出力立ち上がり特性 Output rise characteristics
- 出力立ち下がり特性 Output fall characteristics
- 過電流保護特性 Over current protection (OCP) characteristics
- 過電圧保護特性 Over voltage protection (OVP) characteristics
- 入力電圧瞬停特性 Response to brown out characteristics
- 入力電流波形 Input current waveform

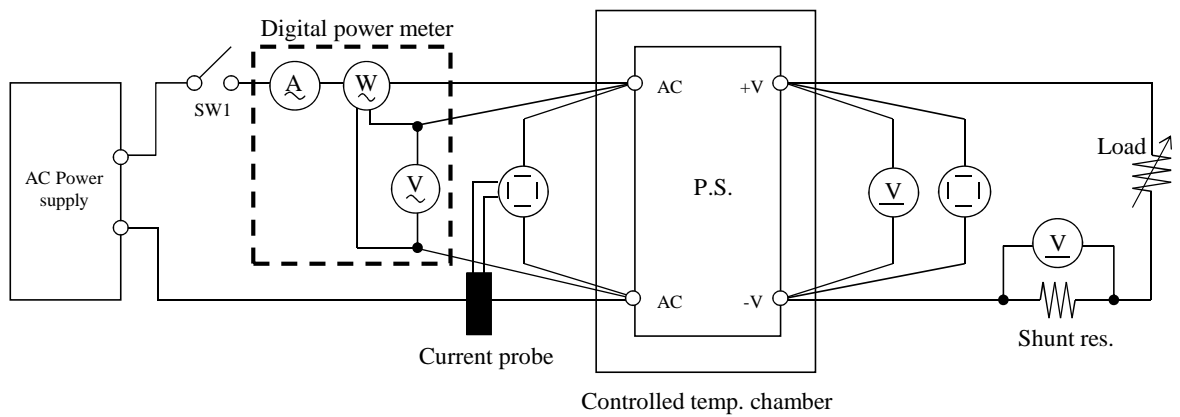

測定回路2 Circuit 2 used for determination

- 過渡応答（負荷急変）特性 Dynamic load response characteristics

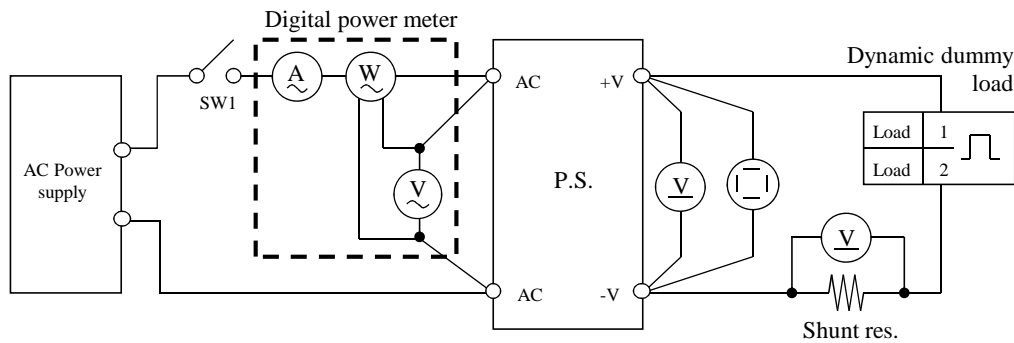

Output current waveform
Iout 50% <==> 100%

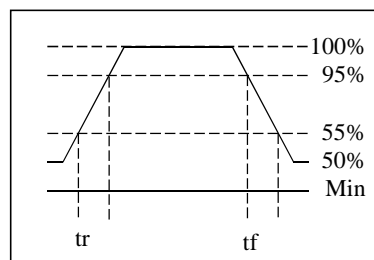

測定回路3 Circuit 3 used for determination

・入力サージ電流 (突入電流) 波形 Inrush current waveform

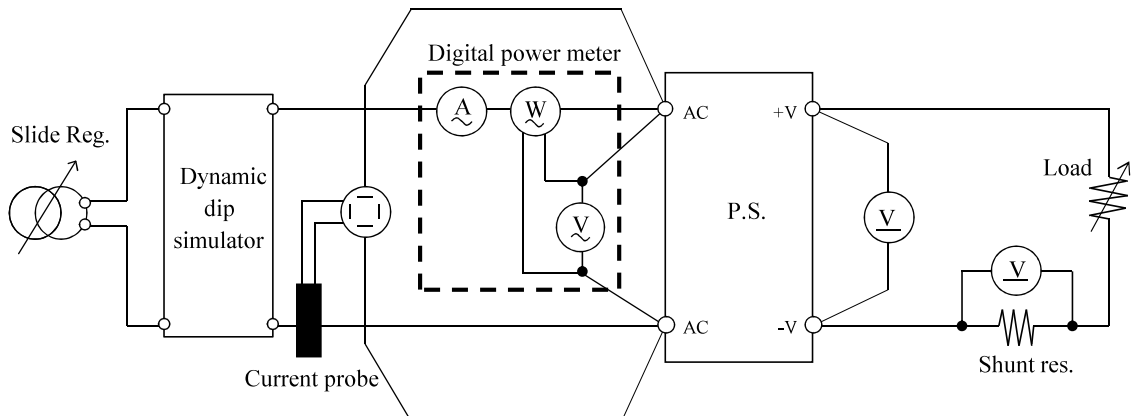

測定回路4 Circuit 4 used for determination

・リーク電流特性 Leakage current characteristics

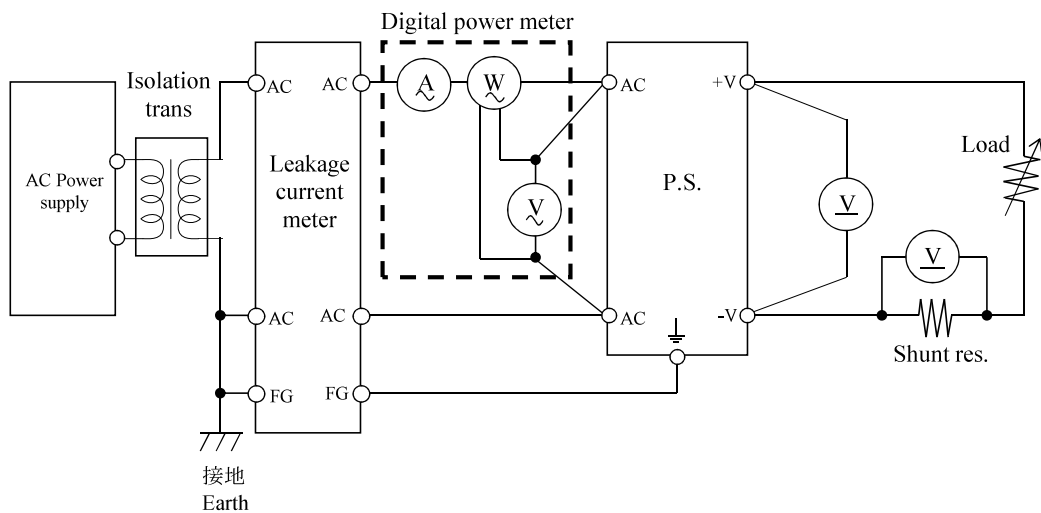

測定回路5 Circuit 5 used for determination

・出力リップル、ノイズ波形 Output ripple and noise waveform

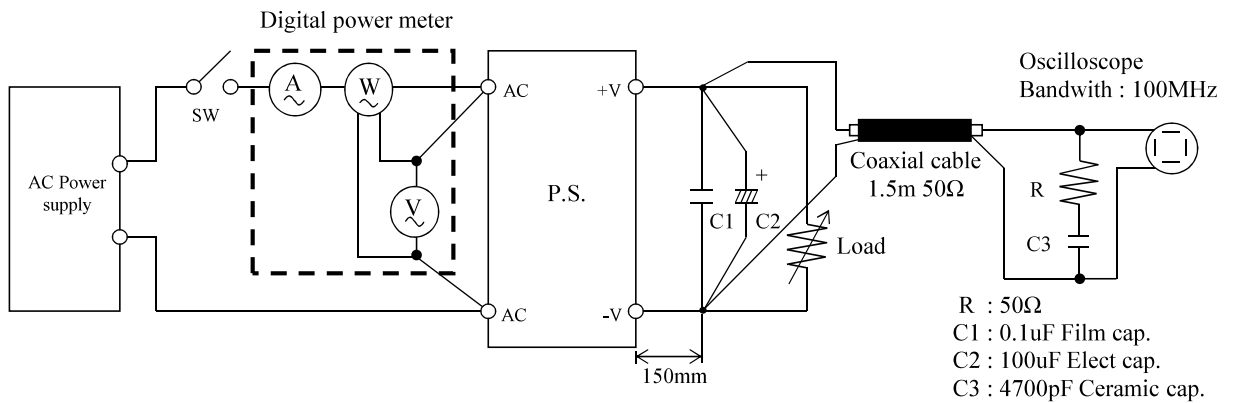

測定構成 Configuration used for determination

・EMI特性 Electro-Magnetic Interference characteristics

(a) 雑音端子電圧 (帰還ノイズ)
Conducted Emission

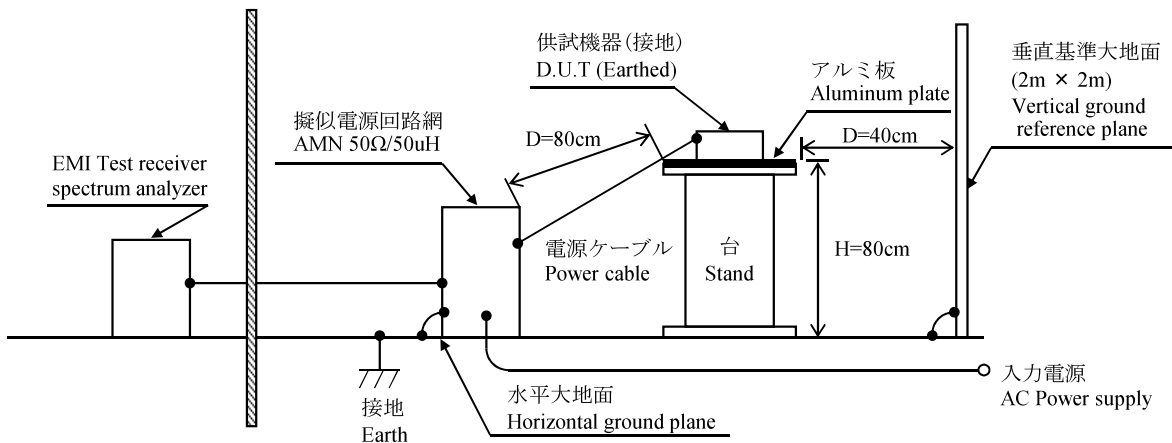

(b) 雑音電界強度 (放射ノイズ)
Radiated Emission

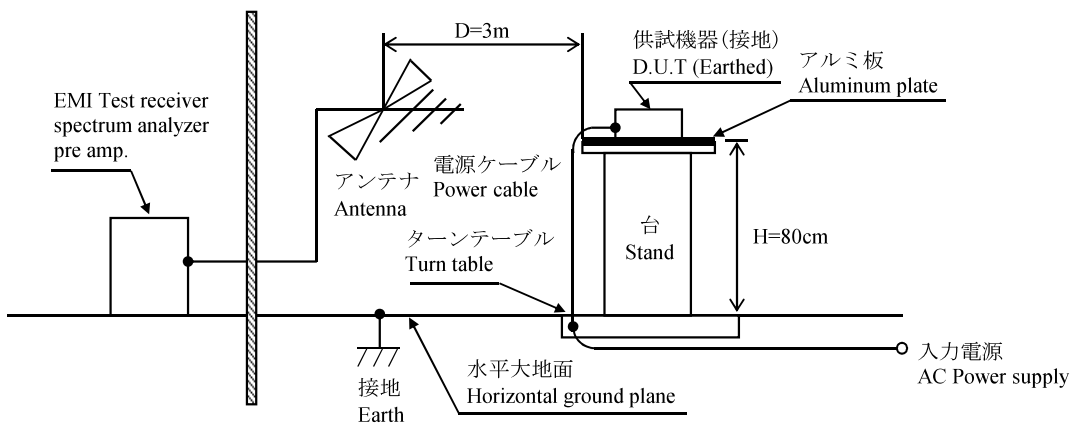

1.2 使用測定機器 List of equipment used

	EQUIPMENT USED	MANUFACTURER	MODEL NO.
1	DIGITAL STORAGE OSCILLOSCOPE	YOKOGAWA ELECT.	DL9040L / DLM2054
2	DIGITAL MULTIMETER	AGILENT	34970A
3	DIGITAL POWER METER	YOKOGAWA ELECT.	WT110 / WT210
4	CURRENT PROBE	YOKOGAWA ELECT.	701928 / 701930
5	DYNAMIC DUMMY LOAD	TAKASAGO	FK-400L / FK-600L
6	DUMMY LOAD	PCN	RHF250 SIRIES
7	SLIDE REGULATOR	MATSUNAGA	SD-2625
8	ISOLATION TRANS	NOISEKEN	TF2302P
9	CVCF	TAKASAGO	AA2000XG
10	CVCF	NF	ES10000S
11	LEAKAGE CURRENT METER	HIOKI	3156
12	DYNAMIC DIP SIMULATOR	TAKAMISAWA	PSA-210
13	CONTROLLED TEMP. CHAMBER	ESPEC	SU-240
14	EMI TEST RECEIVER / SPECTRUM ANALYZER	ROHDE & SCHWARZ	ESCI
15	PRE AMP.	SONOMA	310N
16	AMN	SCHWARZBECK	NNLK8121
17	ANTENNA	SCHWARZBECK	CBL61111D
18	HARMONIC / FLICKER ANALYZER	KIKUSUI	KHA1000
19	SINGLE-PHASE MASTER	NF	4420
20	REFERENCE IMPEDANCE NETWORK 20A	NF	4150
21	MULTI OUTLET UNIT	KIKUSUI	OT01-KHA

1.3 評価負荷条件 Load conditions

※ 入力電圧によって、下記のとおり出力ディレーティングが必要です。
Output derating is required by the input voltage.

Output voltage : 5V

Vin	Iou : Full load	5V
85VAC	90%	18.9A
90 - 265VAC	100%	21.0A

Output voltage : 12V, 24V

Vin	Iout : Full load	12V	24V
85VAC	80%	10.4A	5.2A
100VAC	92%	12.0A	6.0A
110 - 265VAC	100%	13.0A	6.5A

2.1 静特性 Steady state data

(1) 入力・負荷・温度変動／出力起動・遮断電圧

Regulation - line and load, Temperature drift / Start up voltage and Drop out voltage

5V		1. Regulation - line and load				Condition Ta : 25 °C	
Iout \ Vin	90VAC	100VAC	200VAC	265VAC	Line regulation		
0%	5.036V	5.036V	5.036V	5.036V	0mV	0.000%	
50%	5.023V	5.023V	5.023V	5.023V	0mV	0.000%	
Full load	5.010V	5.010V	5.010V	5.010V	0mV	0.000%	
Load regulation	26mV	26mV	26mV	26mV			
	0.520%	0.520%	0.520%	0.520%			

2. Temperature drift

Conditions Vin : 100 VAC
Iout : Full load

Ta	-10°C	+25°C	+40°C	temperature stability	
Vout	5.005V	5.010V	5.007V	5mV	0.100%

3. Start up voltage and Drop out voltage

Conditions Ta : 25 °C
Iout : 100 %

Start up voltage (Vin)	77VAC
Drop out voltage (Vin)	63VAC

12V		1. Regulation - line and load				Condition Ta : 25 °C	
Iout \ Vin	100VAC	110VAC	200VAC	265VAC	Line regulation		
0%	12.091V	12.091V	12.091V	12.091V	0mV	0.000%	
50%	12.083V	12.083V	12.083V	12.083V	0mV	0.000%	
Full load	12.076V	12.075V	12.075V	12.075V	0mV ※1	0.000%	
Load regulation	8mV	16mV	16mV	16mV			
	0.067%	0.133%	0.133%	0.133%			

2. Temperature drift

Conditions Vin : 110 VAC
Iout : Full load

Ta	-10°C	+25°C	+40°C	temperature stability	
Vout	12.068V	12.075V	12.071V	7mV	0.058%

3. Start up voltage and Drop out voltage

Conditions Ta : 25 °C
Iout : 100 %

Start up voltage (Vin)	78VAC
Drop out voltage (Vin)	71VAC

24V		1. Regulation - line and load				Condition Ta : 25 °C	
Iout \ Vin	100VAC	110VAC	200VAC	265VAC	Line regulation		
0%	24.032V	24.033V	24.033V	24.033V	1mV	0.004%	
50%	24.027V	24.027V	24.027V	24.027V	0mV	0.000%	
Full load	24.022V	24.021V	24.021V	24.021V	0mV ※1	0.000%	
Load regulation	5mV	12mV	12mV	12mV			
	0.021%	0.050%	0.050%	0.050%			

2. Temperature drift

Conditions Vin : 110 VAC
Iout : Full load

Ta	-10°C	+25°C	+40°C	temperature stability	
Vout	24.000V	24.021V	24.035V	35mV	0.146%

3. Start up voltage and Drop out voltage

Conditions Ta : 25 °C
Iout : 100 %

Start up voltage (Vin)	75VAC
Drop out voltage (Vin)	68VAC

※1 Line regulation (12V,24V) : 110VAC - 265VAC

(2) リプルノイズ電圧対入力電圧
Ripple noise voltage vs. Input voltage

Conditions Iout : Full load
Ta : -10 °C
25 °C
40 °C



5V

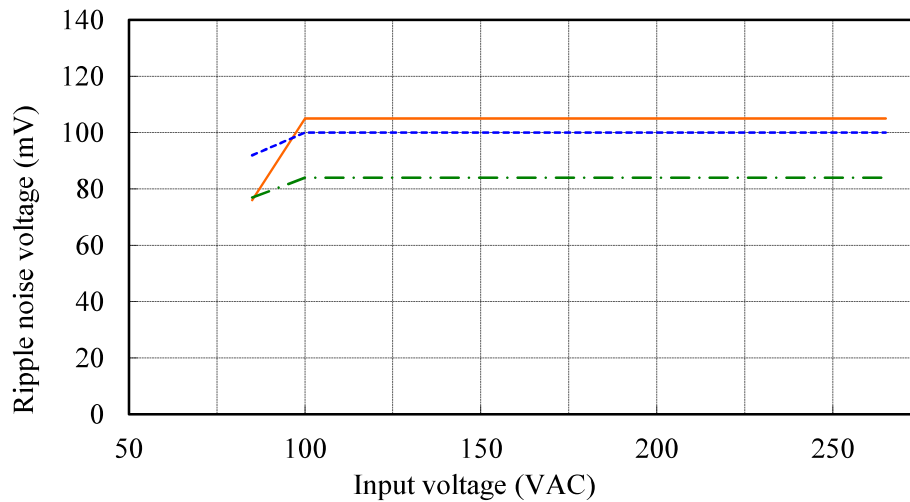

12V

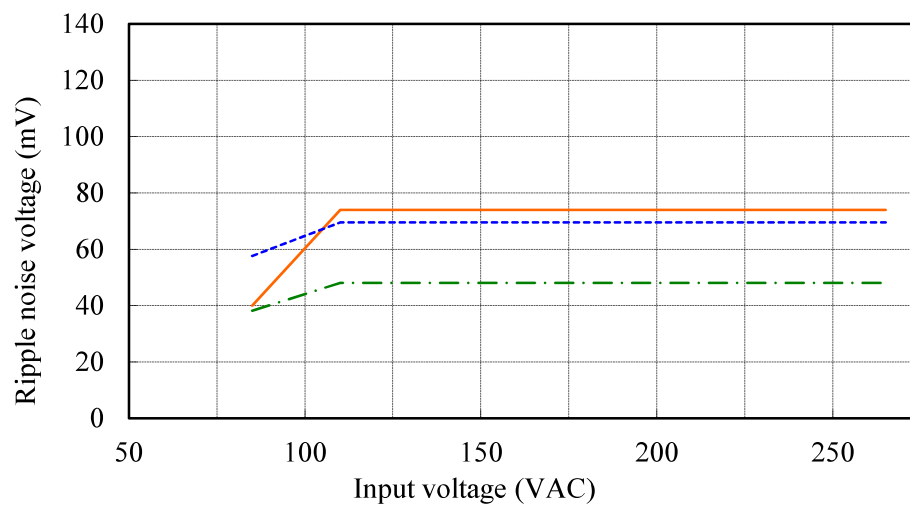

24V

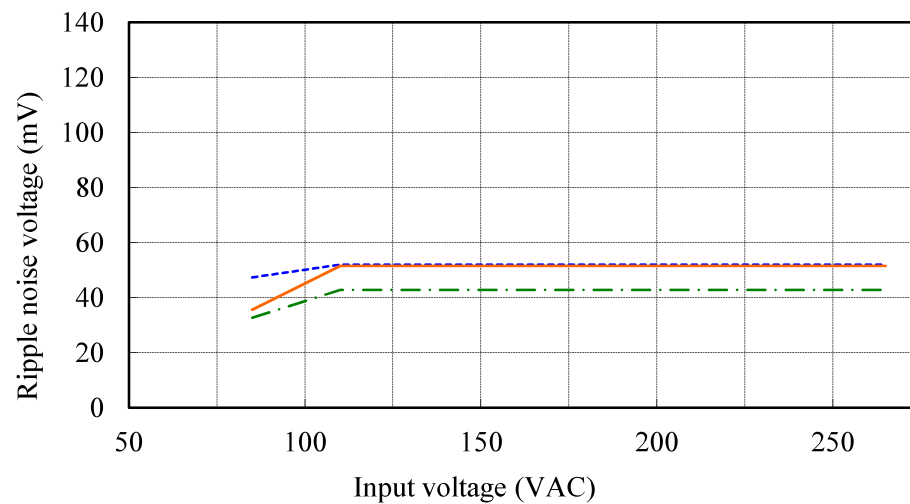

RWS150B

(3) 効率・力率対出力電流

Efficiency and Power factor vs. Output current

Conditions Vin : 90 VAC
 100 VAC
 110 VAC
 200 VAC
 265 VAC
 Ta : 25 °C

5V

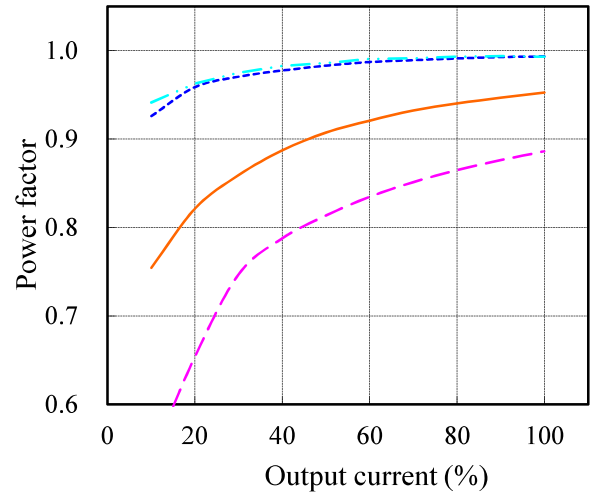
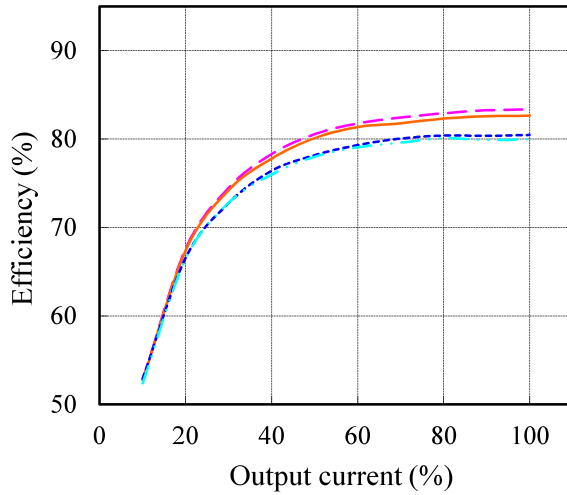

12V

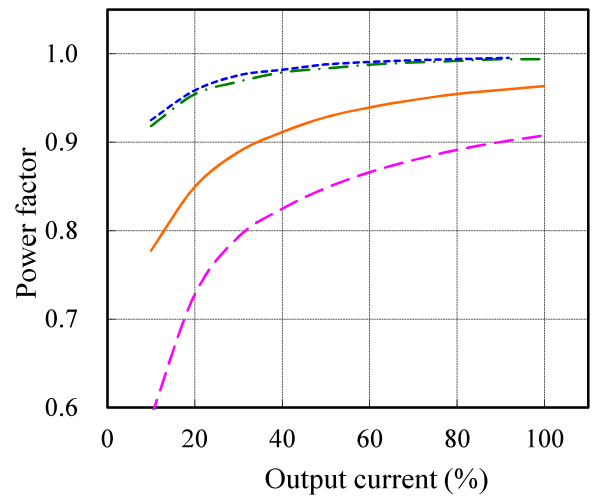
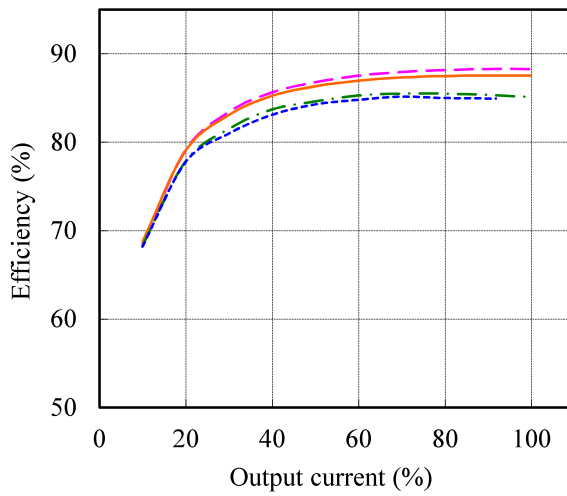

24V

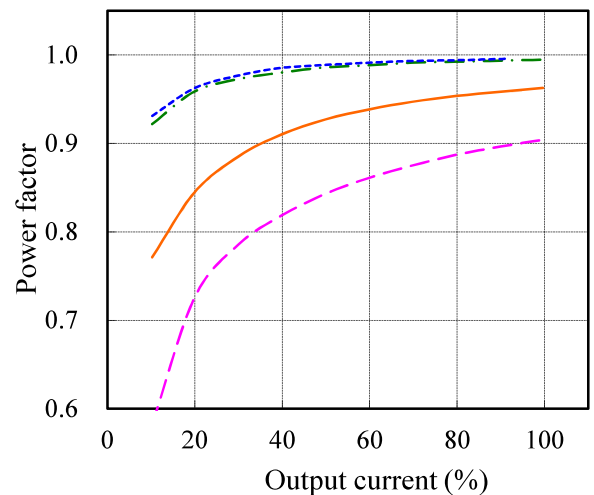
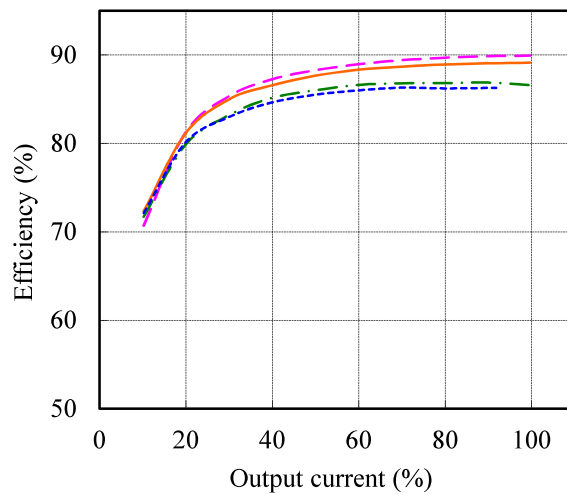

RWS150B

(4) 入力電力対出力電流 Input power vs. Output current

Conditions Vin : 90 VAC
 100 VAC
 110 VAC
 200 VAC
 265 VAC
 Ta : 25 °C

5V

Vin	Input power
	Iout : 0%
90VAC	2.7W
100VAC	2.8W
200VAC	2.9W
265VAC	3.4W

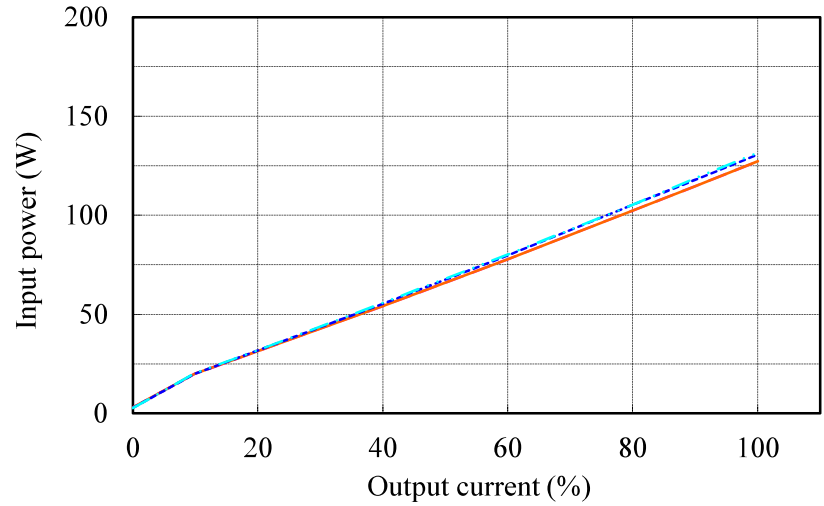

12V

Vin	Input power
	Iout : 0%
100VAC	2.3W
110VAC	2.7W
200VAC	2.8W
265VAC	2.9W

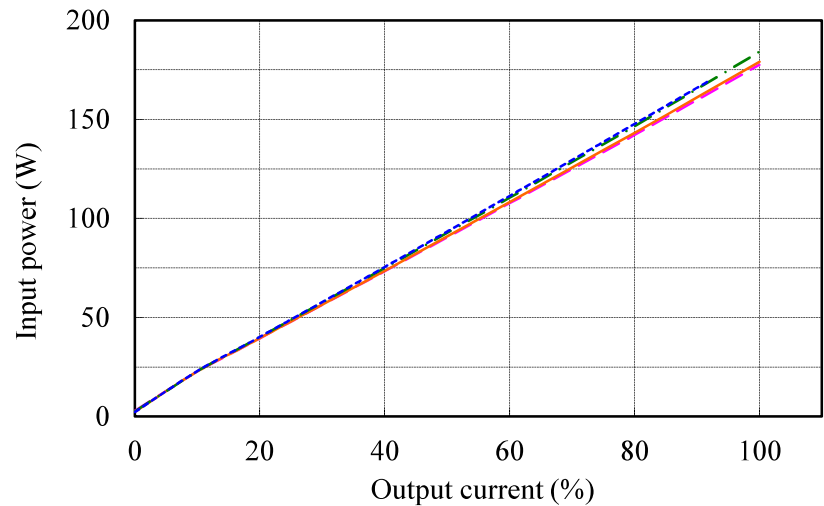

24V

Vin	Input power
	Iout : 0%
100VAC	2.4W
110VAC	2.8W
200VAC	2.9W
265VAC	3.0W

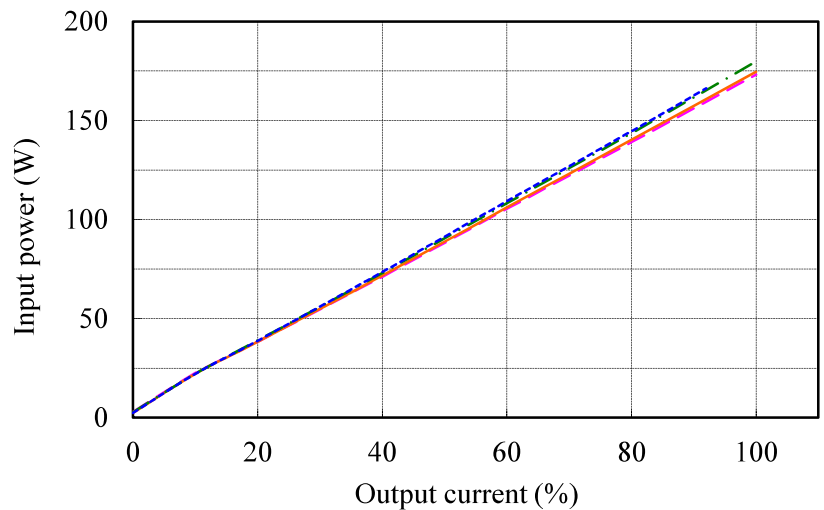

(5) 入力電流対出力電流
Input current vs. Output current

Conditions Vin : 90 VAC
100 VAC
110 VAC
200 VAC
265 VAC
Ta : 25 °C

5V

Vin	Input current
	Iout : 0%
90VAC	0.04A
100VAC	0.04A
200VAC	0.04A
265VAC	0.05A

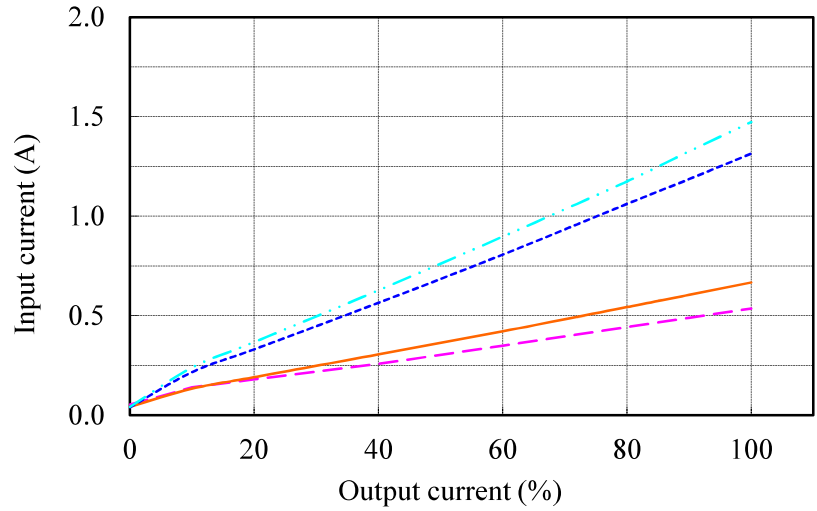

12V

Vin	Input current
	Iout : 0%
100VAC	0.03A
110VAC	0.04A
200VAC	0.04A
265VAC	0.05A

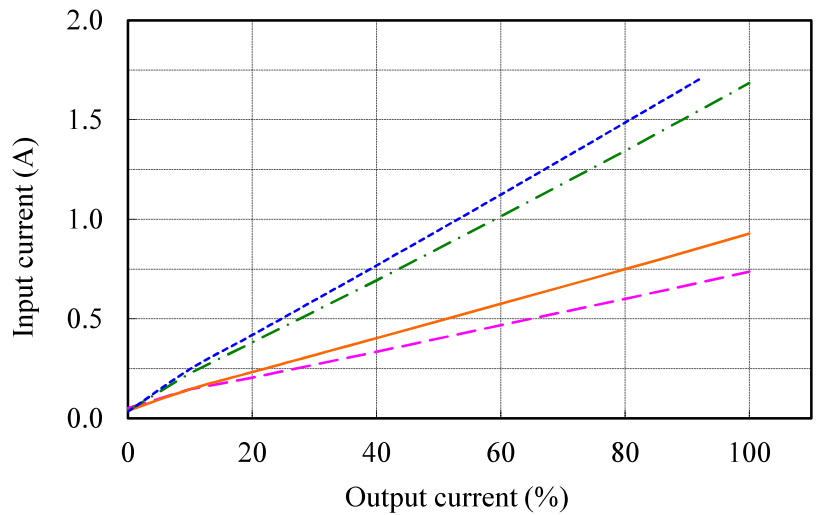

24V

Vin	Input current
	Iout : 0%
100VAC	0.03A
110VAC	0.04A
200VAC	0.04A
265VAC	0.05A

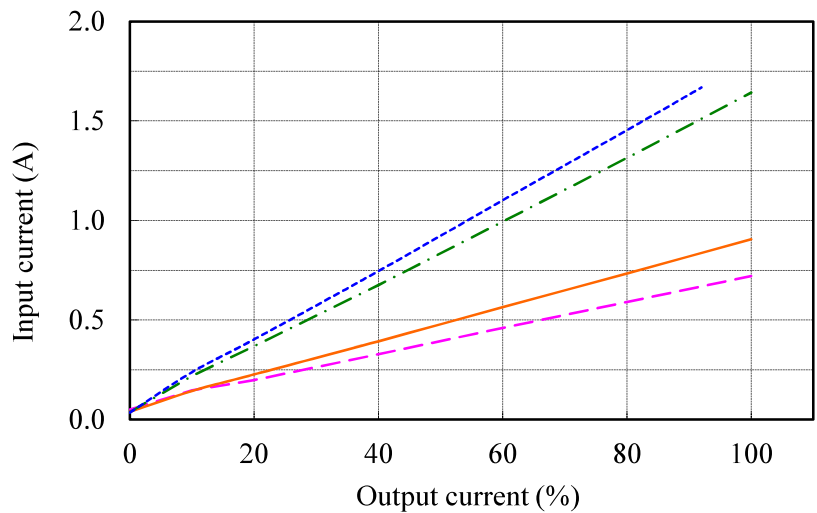

2.2 通電ドリフト特性

Warm up voltage drift characteristics

Conditions Vin : 110 VAC
 Iout : Full load
 Ta : 25 °C

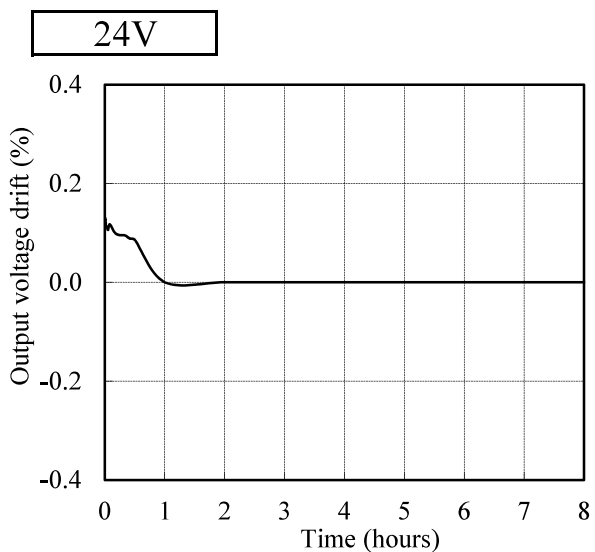
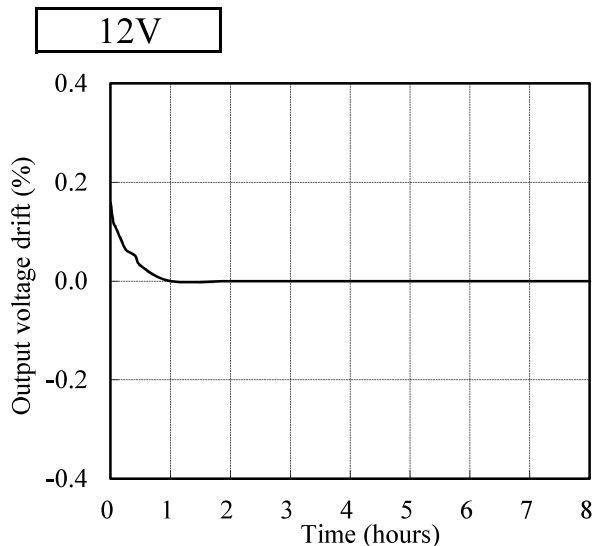
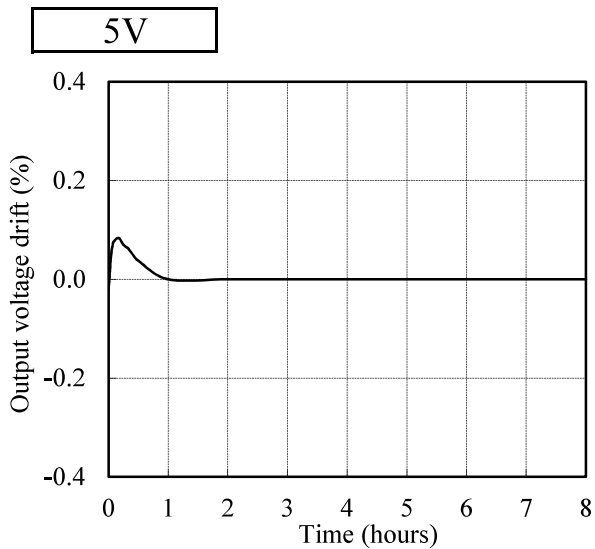

RWS150B

2.3 出力保持時間特性

Hold up time characteristics

Conditions Vin : 110 VAC
 200 VAC
 Ta : 25 °C

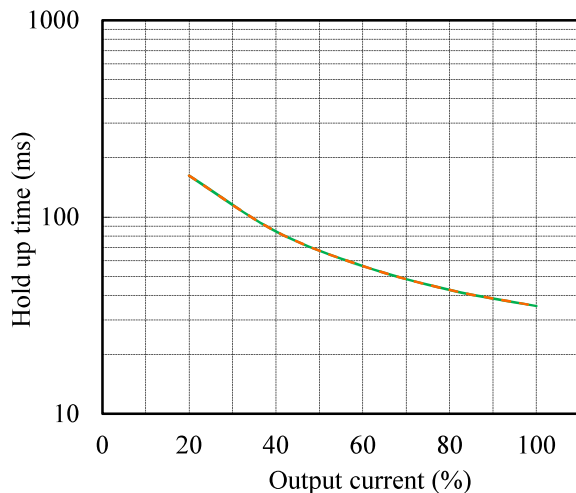
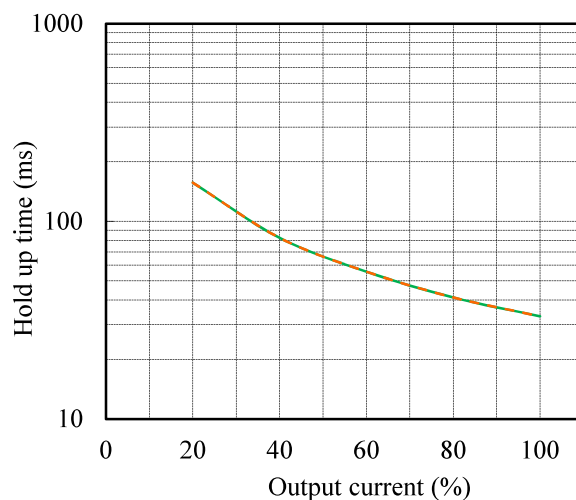
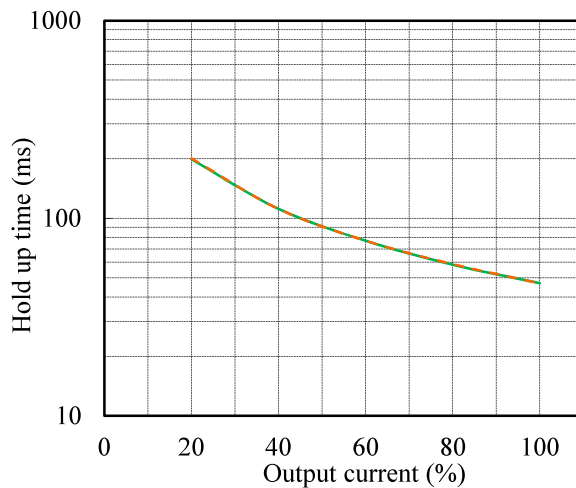

2.4 出力立ち上がり特性
Output rise characteristics

RWS150B

Conditions V_{in} : 100 VAC (A)
110 VAC (B)
200 VAC (C)
265 VAC (D)
 T_a : 25 °C

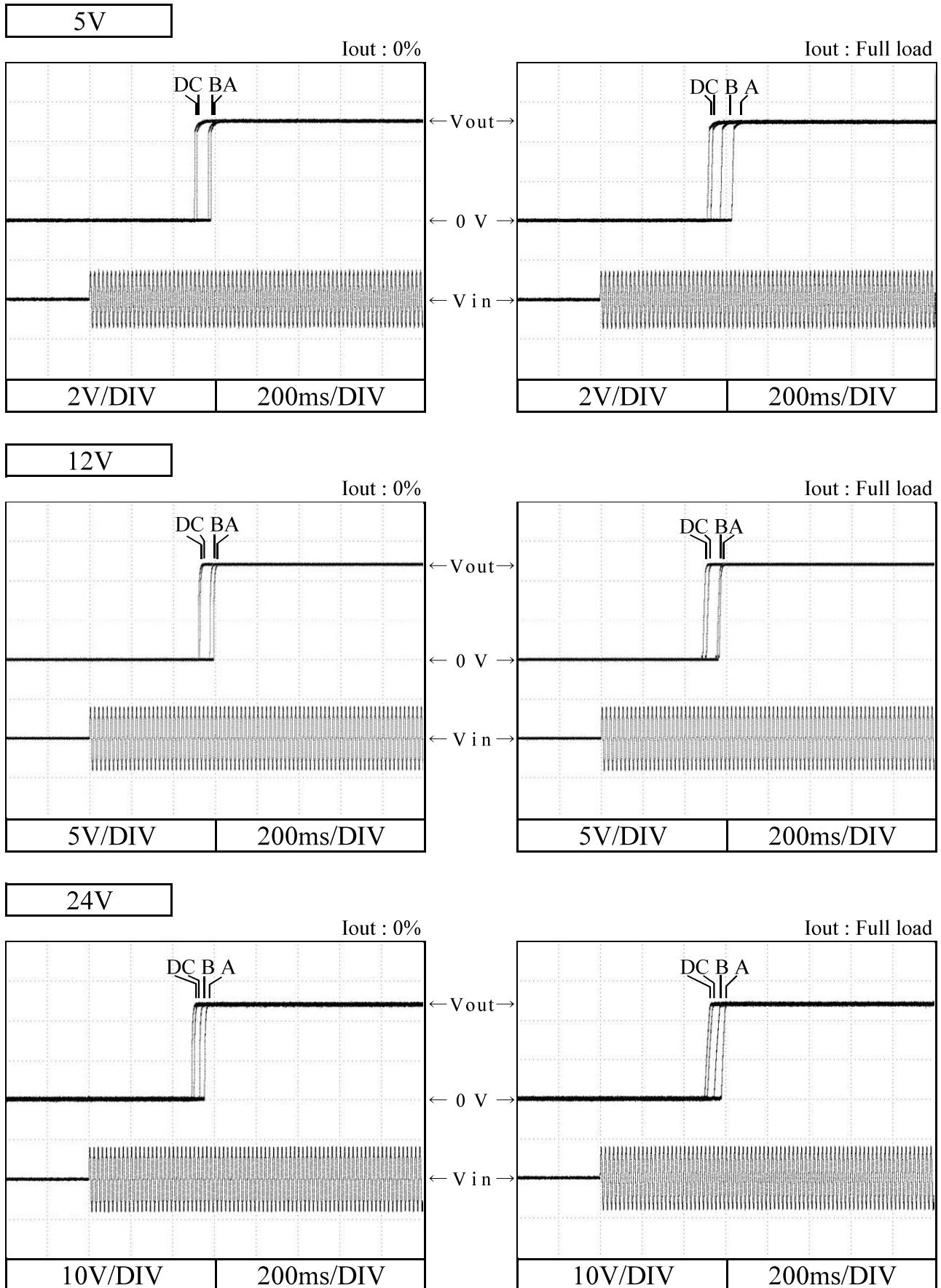

2.5 出力立ち下がり特性
Output fall characteristics

RWS150B

Conditions Vin : 100 VAC (A)
110 VAC (B)
200 VAC (C)
265 VAC (D)
Ta : 25 °C

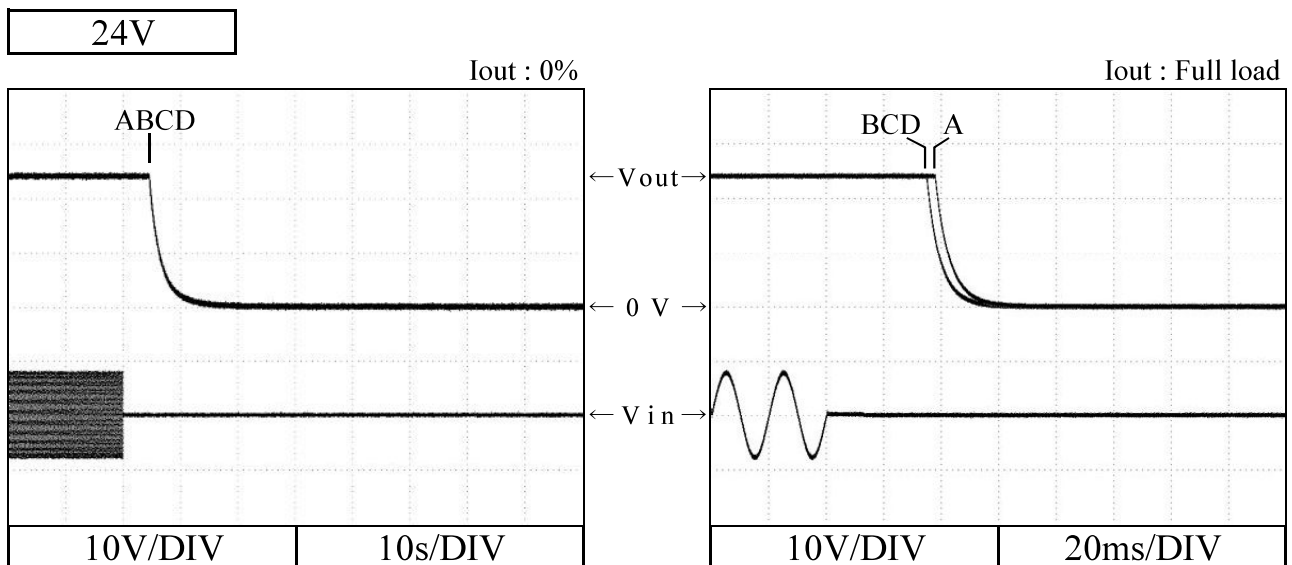
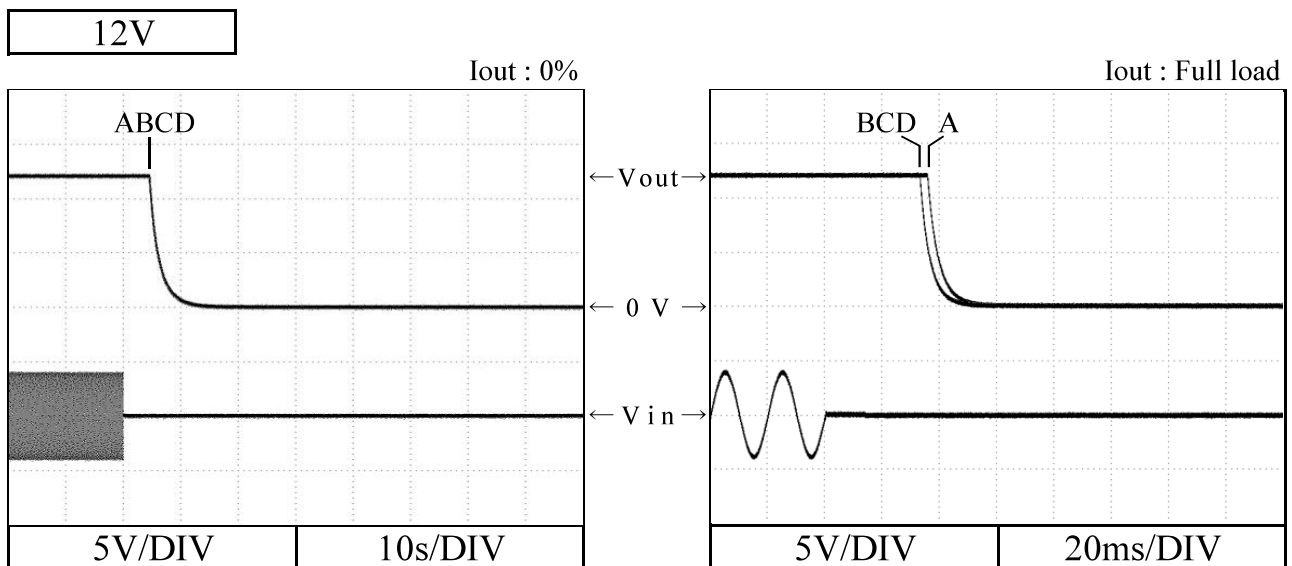
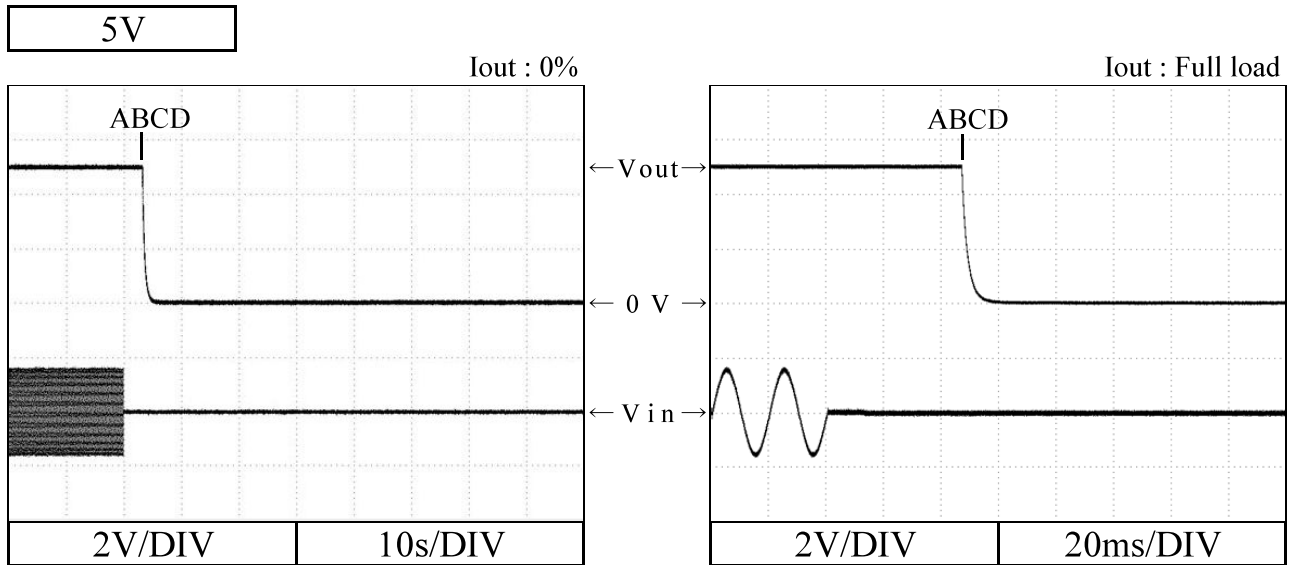

2.6 過電流保護特性

Over current protection (OCP) characteristics

Conditions Vin : 110 VAC
 Ta : -10 °C (---)
 25 °C (---)
 40 °C (—)

5V

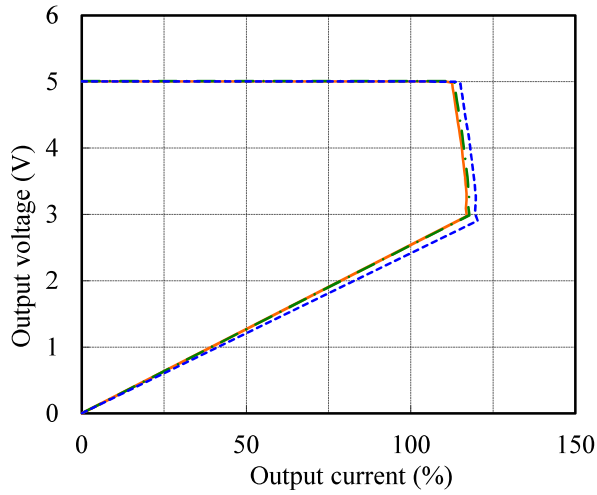

12V

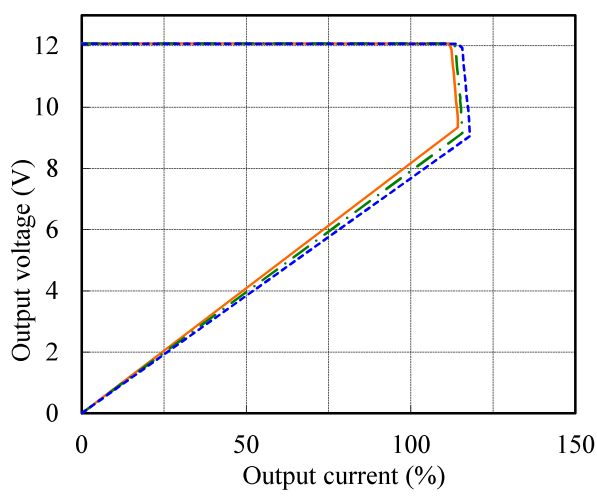

24V

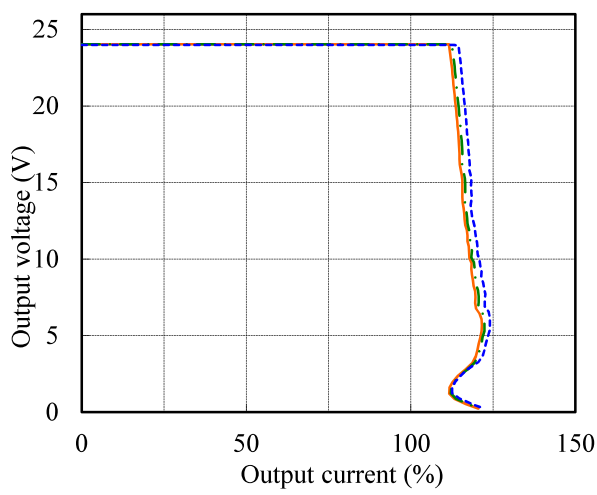

2.7 過電圧保護特性

Over voltage protection (OVP) characteristics

Conditions Vin : 100 VAC
 Iout : 0 %
 Ta : 25 °C

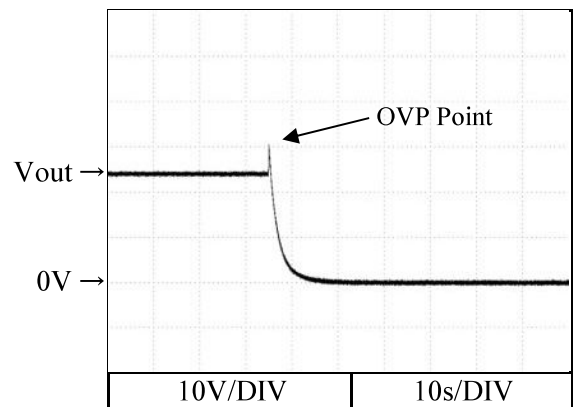
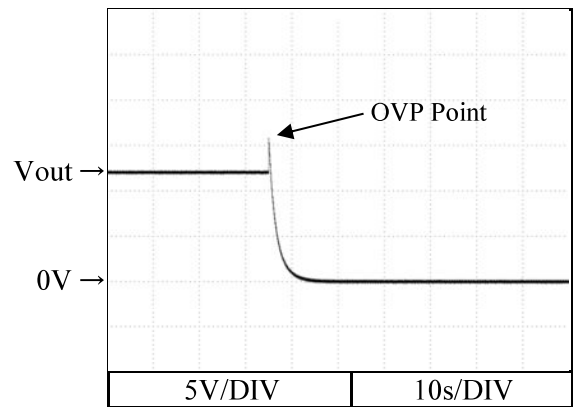
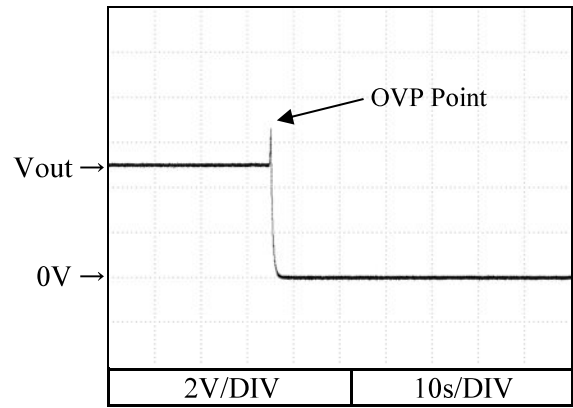

2.8 過渡応答（負荷急変）特性 Dynamic load response characteristics

Conditions Vin : 110 VAC
Iout : 50 % ↔ 100 %
(tr = tf = 50us)
Ta : 25 °C

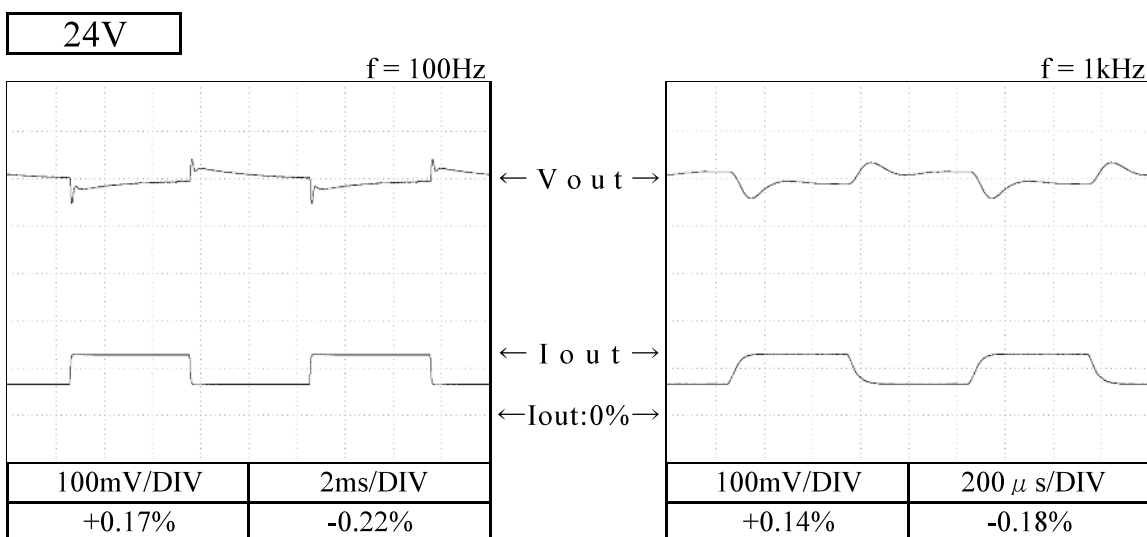
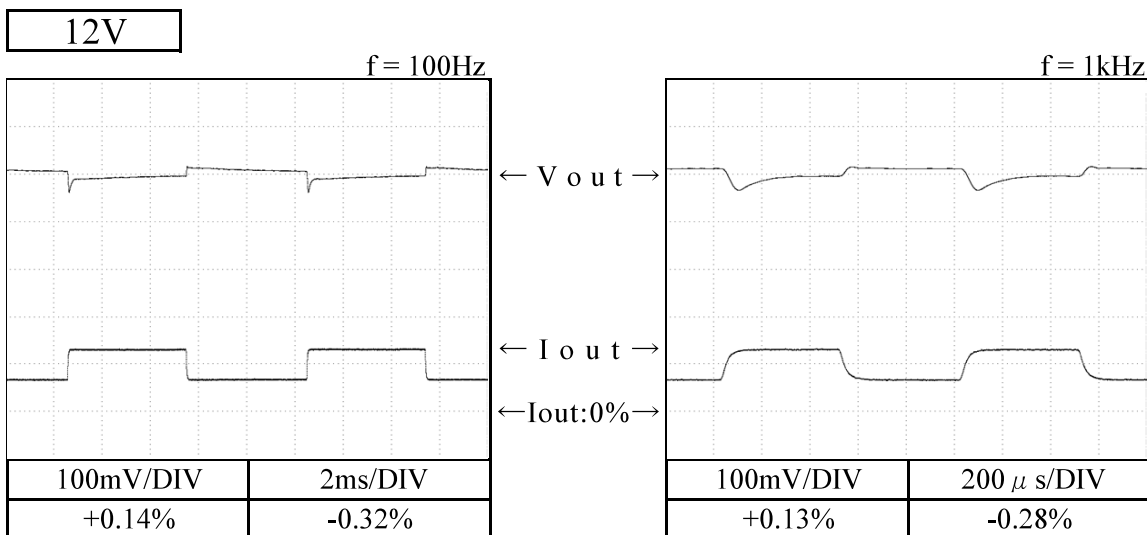
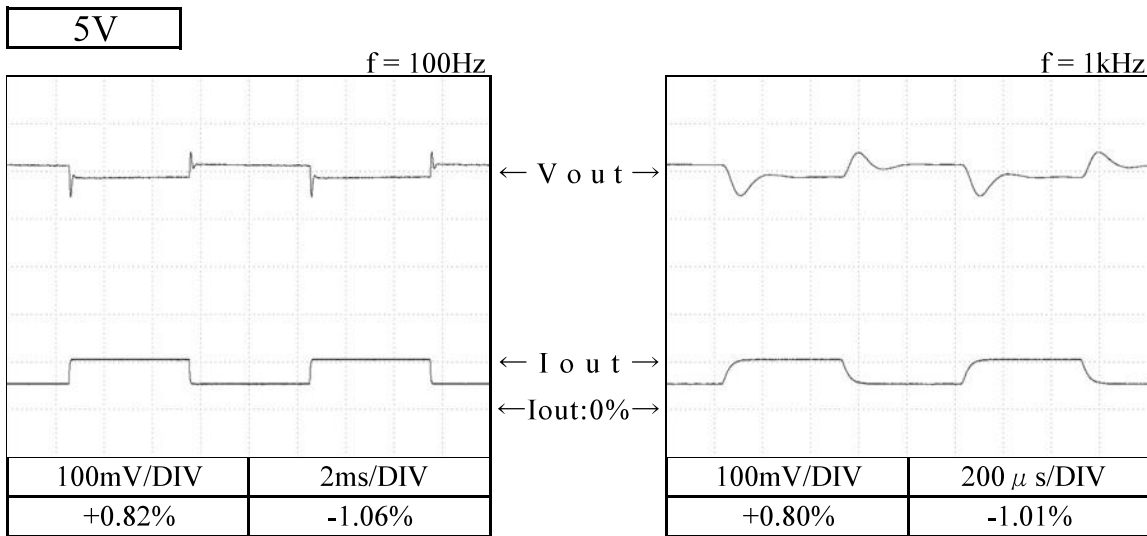

2.9 入力電圧瞬停特性

Response to brown out characteristics

Conditions Ta : 25 °C
Iout : Full load

瞬停時間 Interruption time

A : 出力電圧が低下なし Output voltage does not drop.

B : 出力電圧の低下が0Vまでいかない Output voltage drop down not reaching 0V.

C : 出力電圧が0Vまで低下 Output voltage drops until 0V.

5V

Vin : 110VAC

A = 45ms, C = 46ms

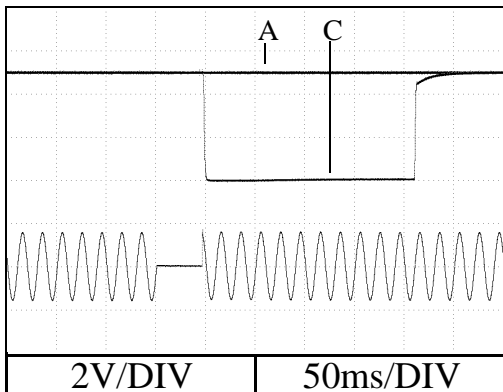

Vin : 200VAC

A = 46ms, C = 47ms

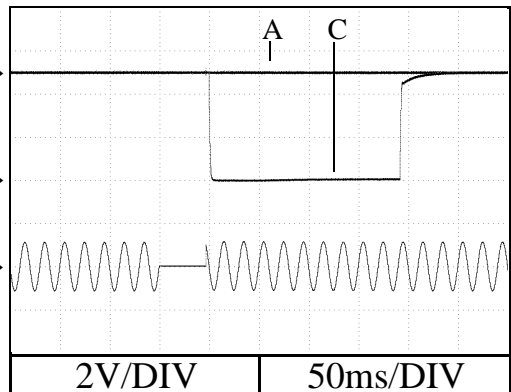

12V

Vin : 110VAC

A = 32ms, C = 33ms

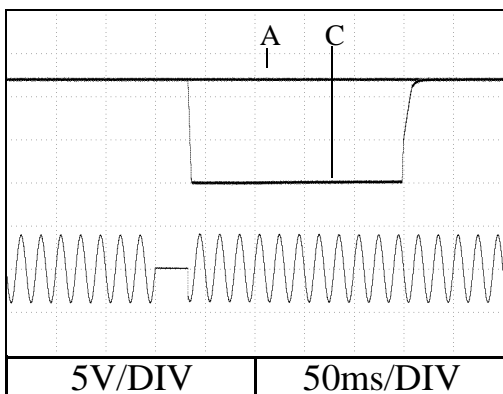

Vin : 200VAC

A = 33ms, C = 34ms

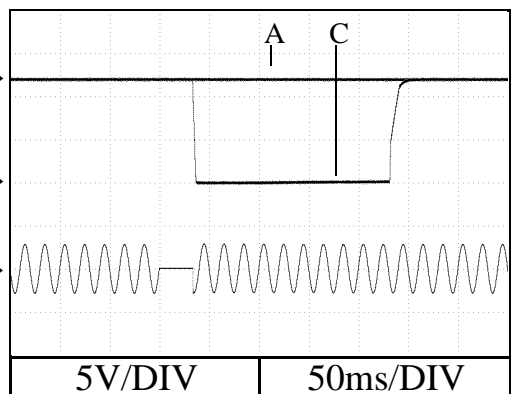

24V

Vin : 110VAC

A = 34ms, C = 35ms

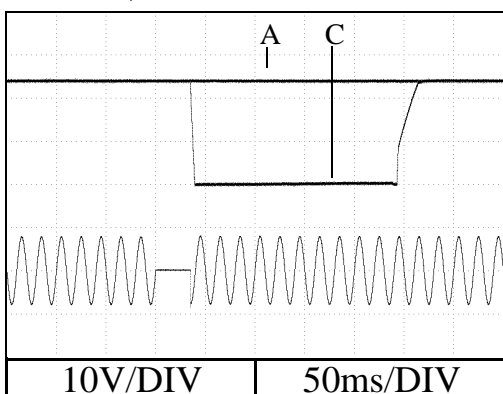

Vin : 200VAC

A = 35ms, C = 36ms

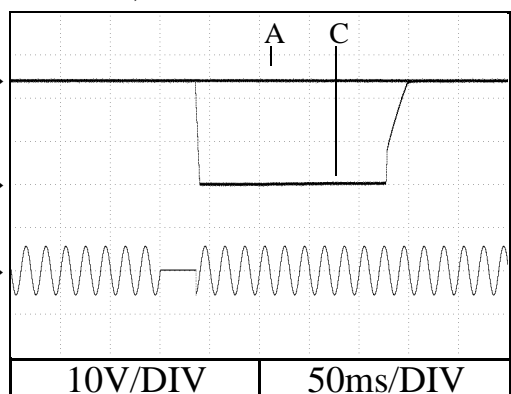

2.10 入力サージ電流（突入電流）波形
Inrush current waveform

12V

Conditions Vin : 100 VAC
Iout : Full load
Ta : 25 °C

Switch on phase angle of input AC voltage
 $\phi = 0^\circ$

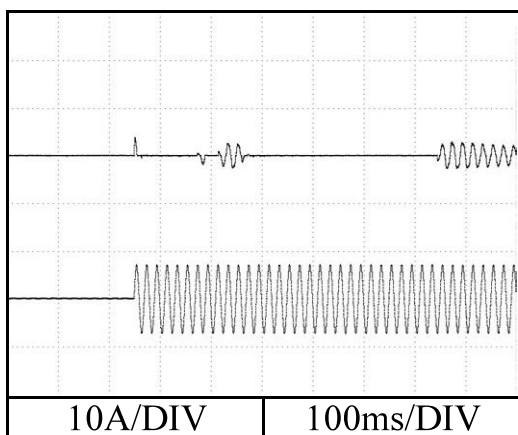

Switch on phase angle of input AC voltage
 $\phi = 90^\circ$

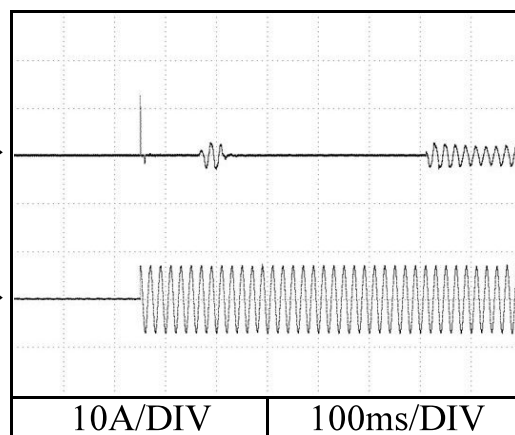

Conditions Vin : 200 VAC
Iout : Full load
Ta : 25 °C

Switch on phase angle of input AC voltage
 $\phi = 0^\circ$

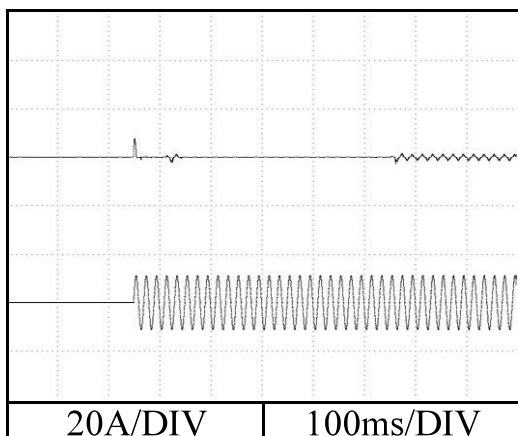

Switch on phase angle of input AC voltage
 $\phi = 90^\circ$

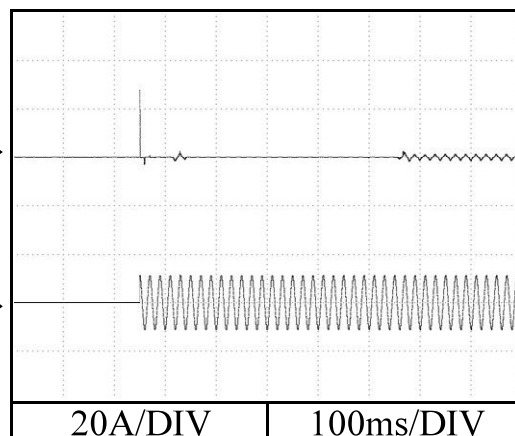

2.11 高調波成分

Input current harmonics

Conditions Iout : Full load

Ta : 25 °C

12V

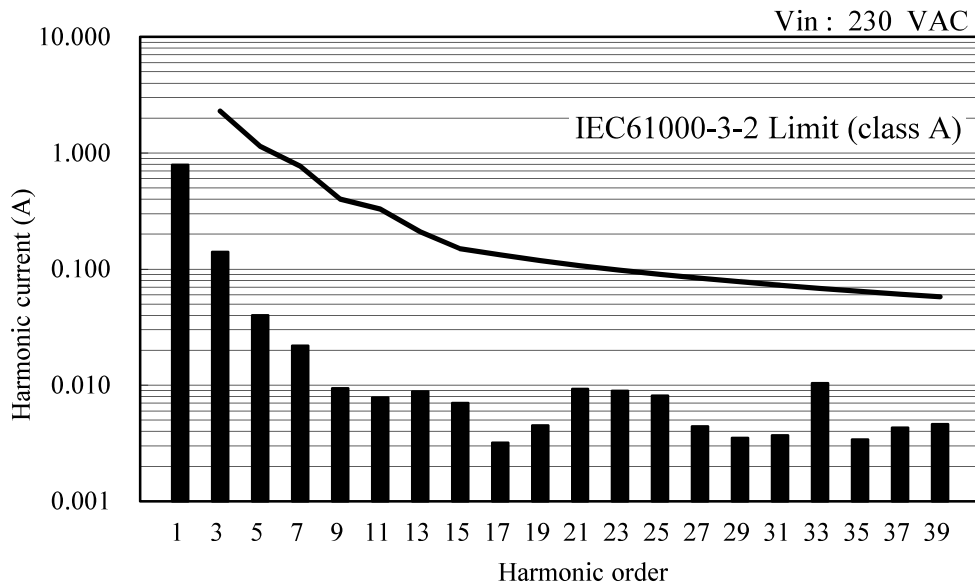
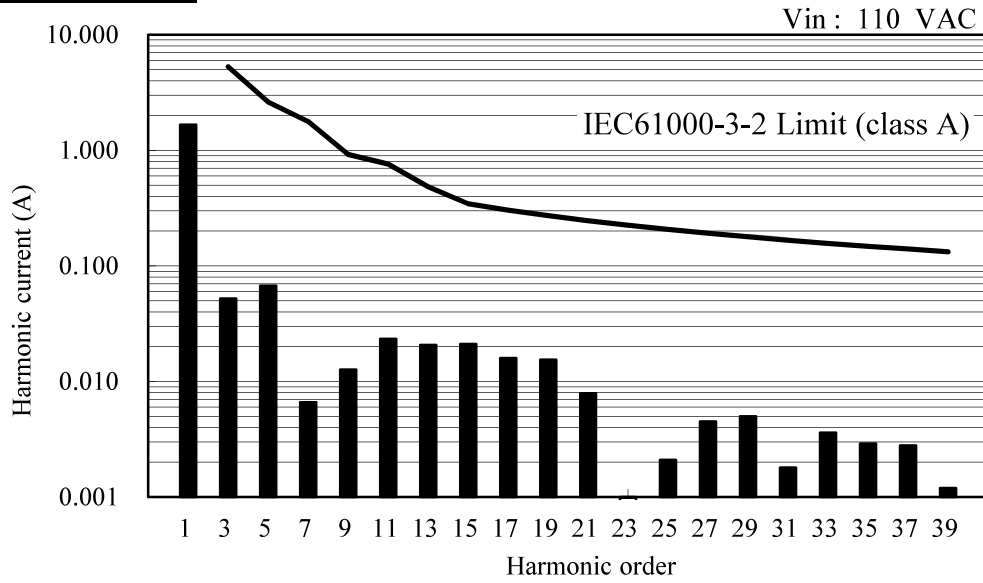

2.12 入力電流波形

Input current waveform

Conditions Iout : Full load

Ta : 25 °C

12V

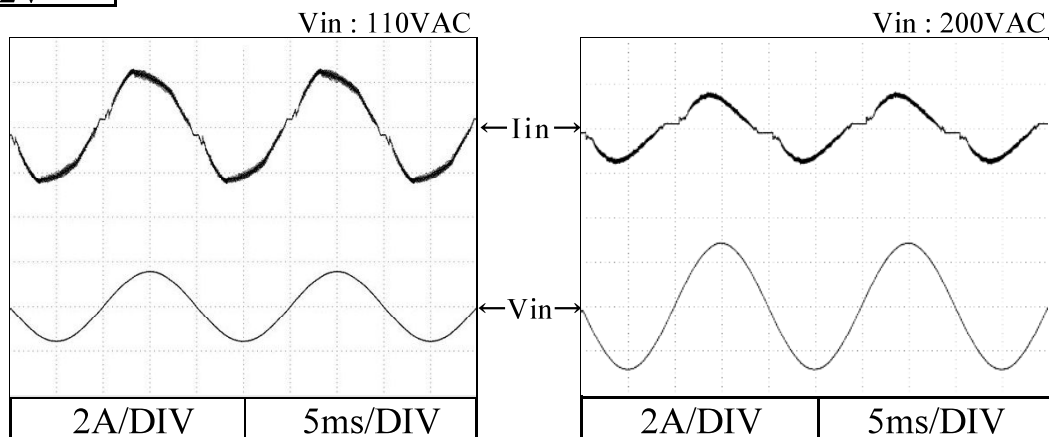

2.13 リーク電流特性
Leakage current characteristics

RWS150B

Conditions Iout : 0 % ———
Full load - - - - -
Ta : 25 °C
Equipment used : 3156 (HIOKI)

12V

f: 50 Hz

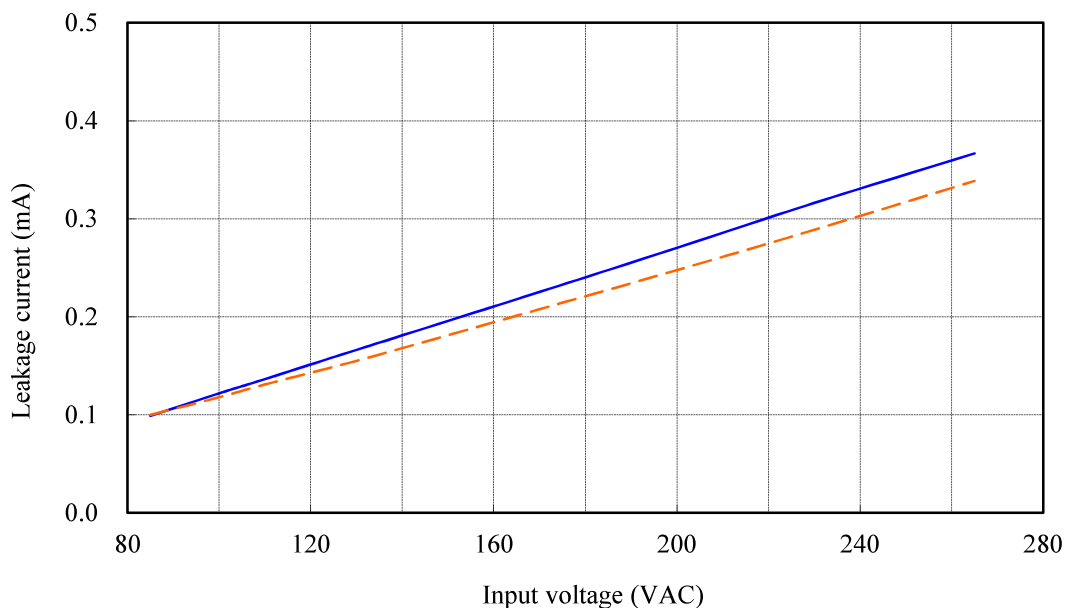

f: 60 Hz

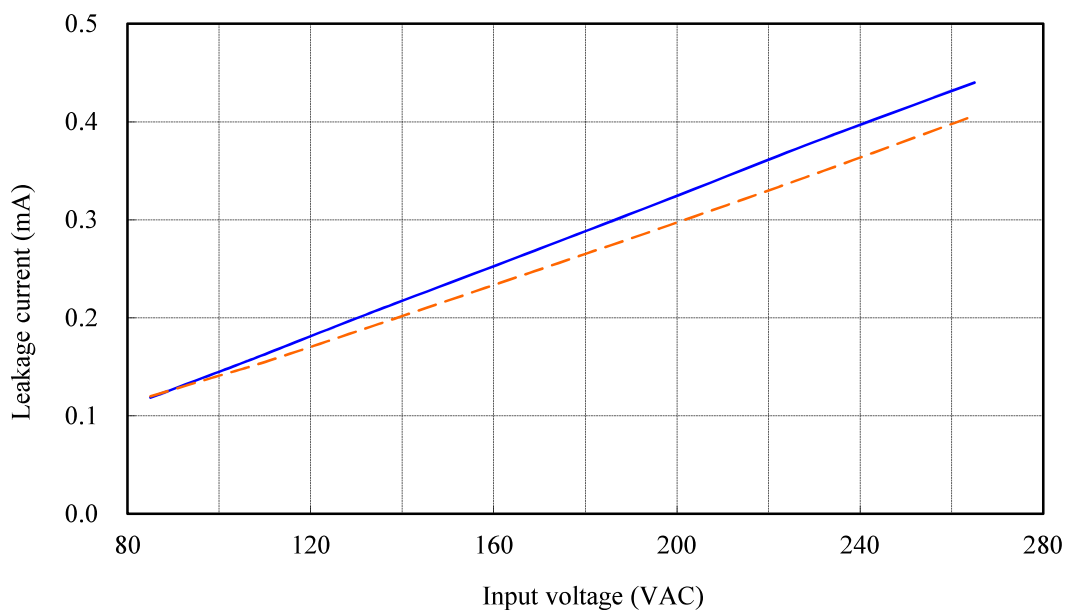

2.14 出力リップル、ノイズ波形
Output ripple and noise waveform

Conditions Vin : 110 VAC
Iout : Full load
Ta : 25 °C

5V

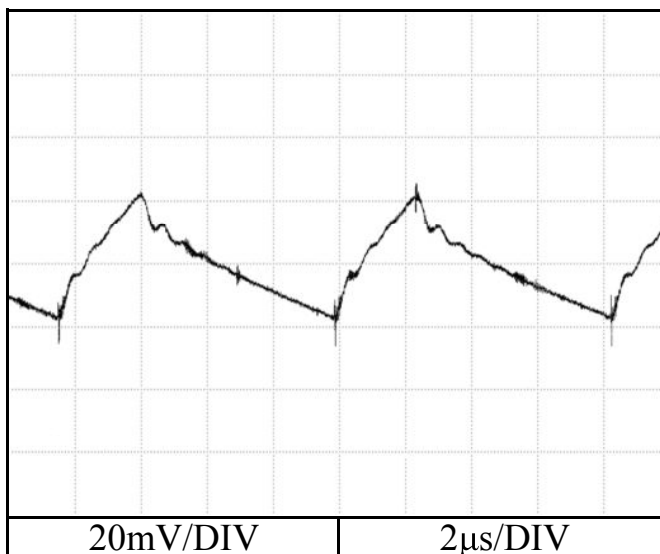

12V

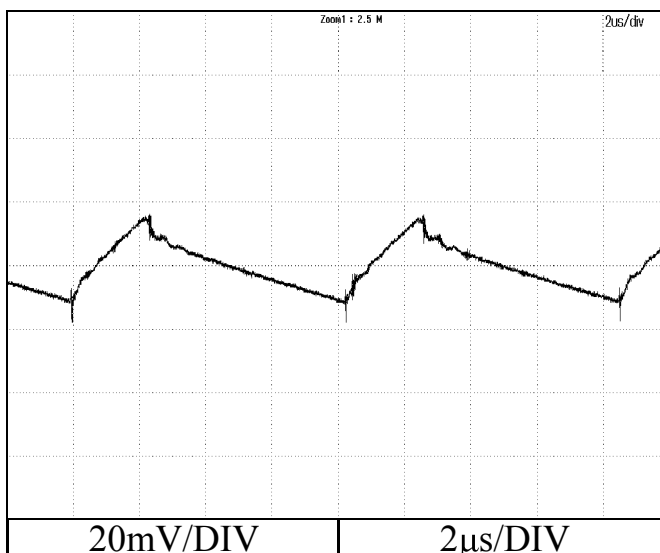

24V

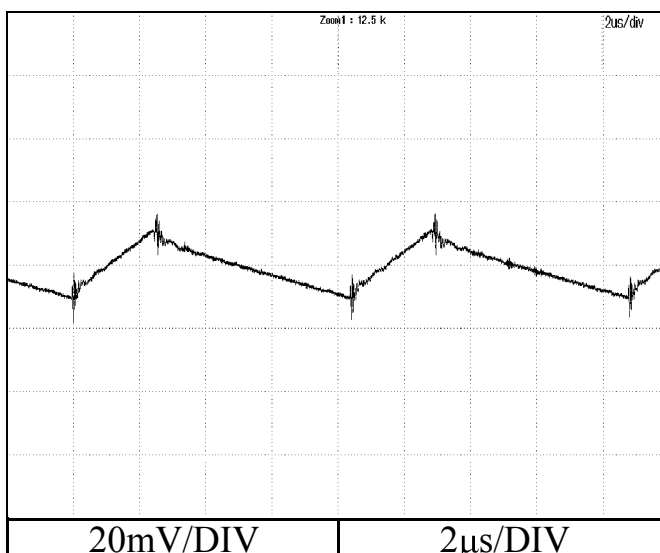

2.15 EMI 特性

Electro-Magnetic Interference characteristics

RWS150B

Conditions Vin : 230 VAC
Iout : Full load
Ta : 25 °C

雑音端子電圧

Conducted Emission

5V

Phase : N

Ref. Data	Point A (238kHz)	
	Limit (dB)	Measure (dB)
QP	62.2	53.7
AV	52.2	45.0

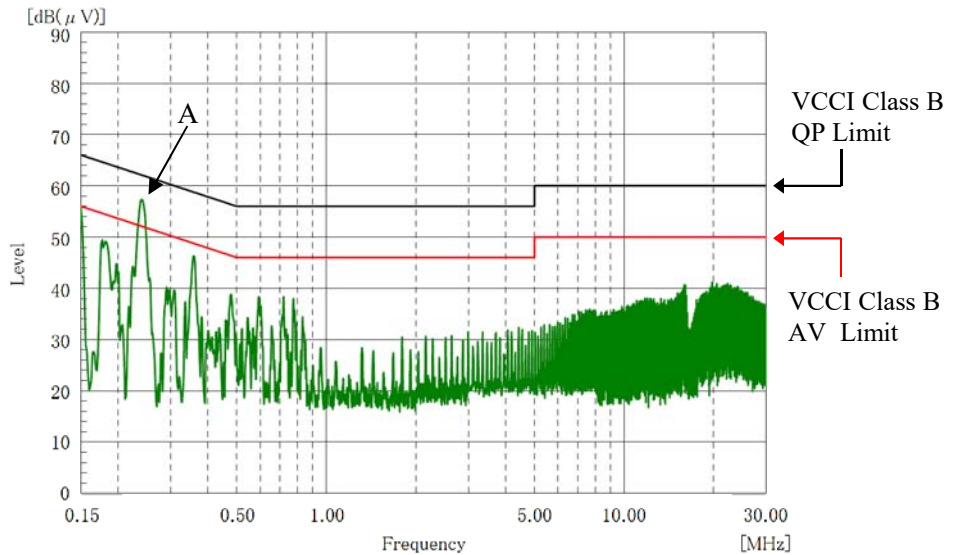

Phase : L

Ref. Data	Point B (238kHz)	
	Limit (dB)	Measure (dB)
QP	62.2	52.0
AV	52.2	37.2

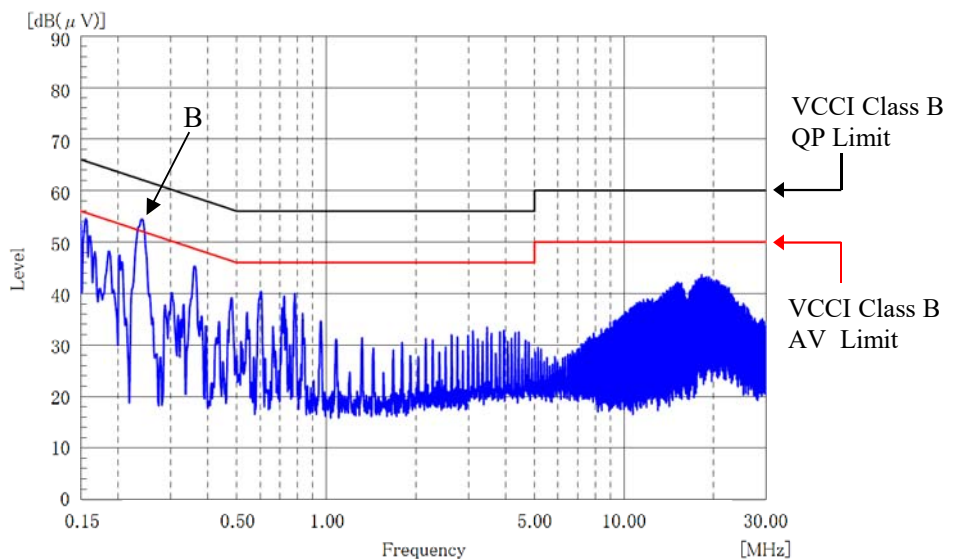

EN55011-B,EN55032-B,FCC-Bの限界値はVCCI class Bの限界値と同じ
Limit of EN55011-B,EN55032-B,FCC-B are same as its VCCI class B.

2.15 EMI 特性

Electro-Magnetic Interference characteristics

RWS150B

Conditions Vin : 230 VAC
Iout : Full load
Ta : 25 °C

雑音端子電圧

Conducted Emission

12V

Phase : N

Ref. Data	Point A (235kHz)	
	Limit (dB)	Measure (dB)
QP	62.3	54.8
AV	52.3	46.2

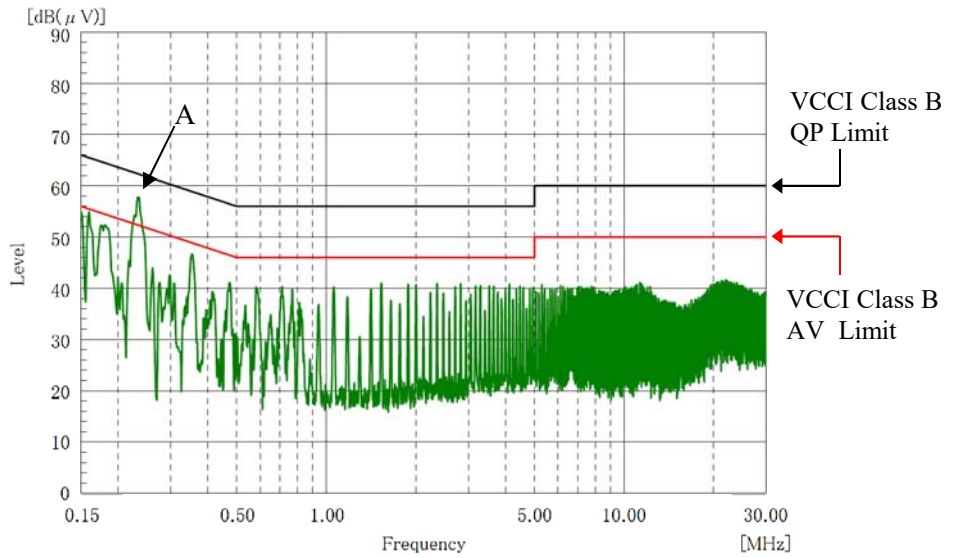

Phase : L

Ref. Data	Point B (235kHz)	
	Limit (dB)	Measure (dB)
QP	62.2	55.5
AV	52.2	46.4

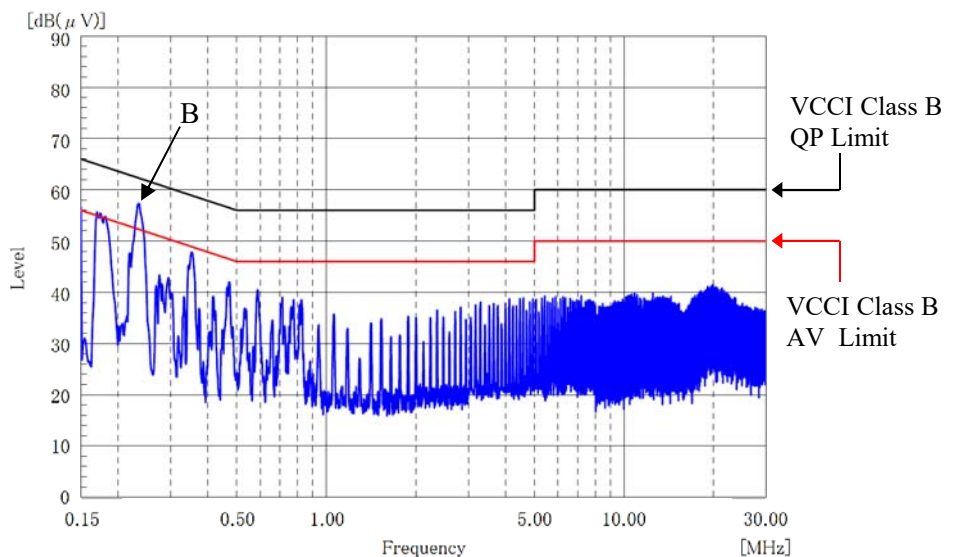

EN55011-B,EN55032-B,FCC-Bの限界値はVCCI class Bの限界値と同じ
Limit of EN55011-B,EN55032-B,FCC-B are same as its VCCI class B.

2.15 EMI 特性

Electro-Magnetic Interference characteristics

RWS150B

Conditions Vin : 230 VAC
Iout : Full load
Ta : 25 °C

雑音端子電圧

Conducted Emission

24V

Phase : N

Ref. Data	Point A (237kHz)	
	Limit (dB)	Measure (dB)
QP	62.2	56.1
AV	52.2	47.0

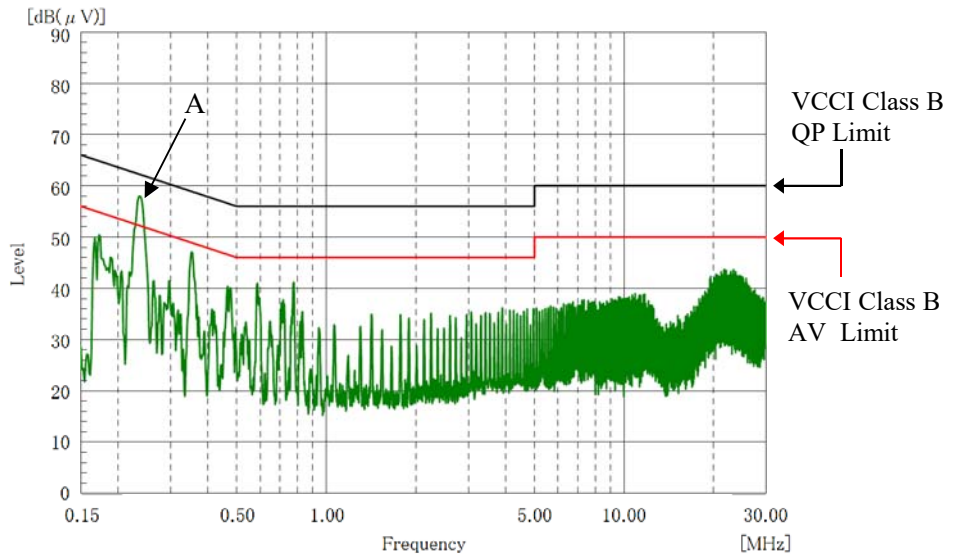

Phase : L

Ref. Data	Point B (240kHz)	
	Limit (dB)	Measure (dB)
QP	62.1	54.0
AV	52.1	44.3

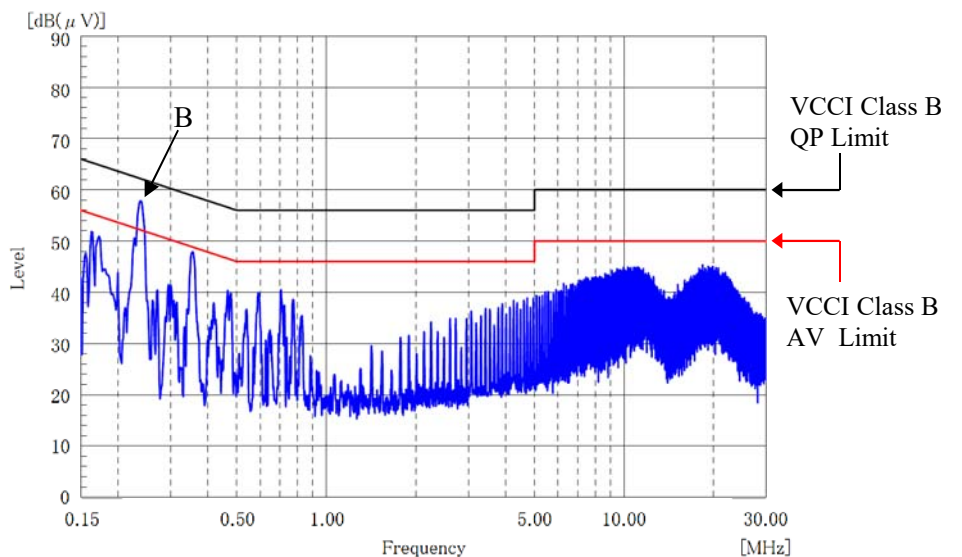

EN55011-B,EN55032-B,FCC-Bの限界値はVCCI class Bの限界値と同じ
Limit of EN55011-B,EN55032-B,FCC-B are same as its VCCI class B.

2.15 EMI 特性
Electro-Magnetic Interference characteristics

RWS150B

Conditions Vin : 230 VAC
Iout : Full load
Ta : 25 °C

雑音電界強度
Radiated Emission

5V

HORIZONTAL

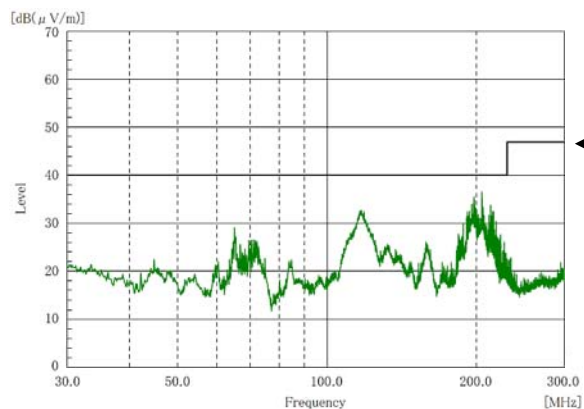

VERTICAL

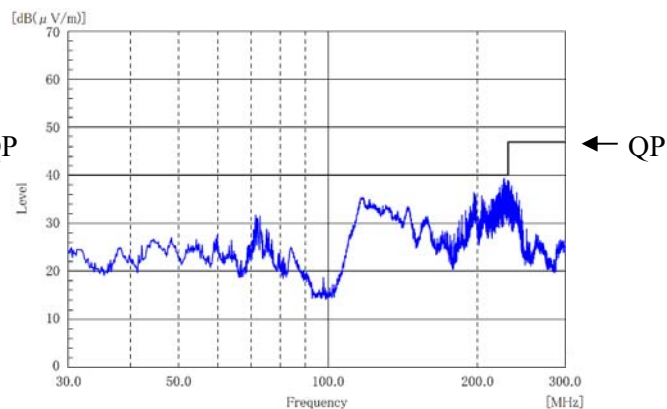

12V

HORIZONTAL

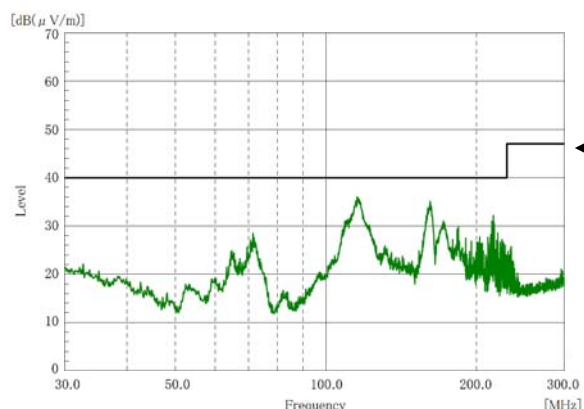

VERTICAL

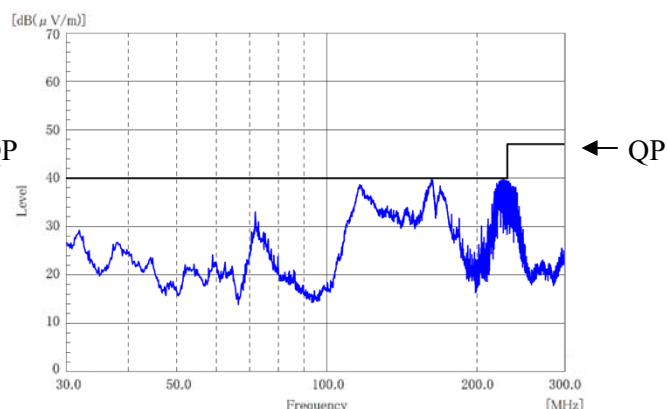

24V

HORIZONTAL

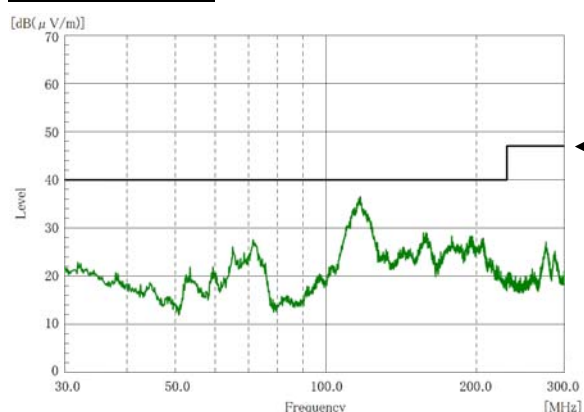

VERTICAL

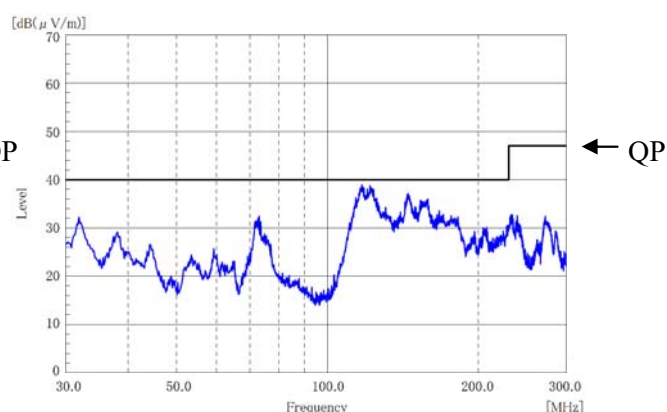

EN55011-B,EN55032-Bの限界値はVCCI class Bの限界値と同じ
Limit of EN55011-B,EN55032-B are same as its VCCI class B.

表示はピーク値
Indication is peak values.