

DELIVERY SPECIFICATION

SPEC. No. A-YFF-d

D A T E : Jun, 2020

To

Non-Controlled Copy

CUSTOMER'S PRODUCT NAME	TDK PRODUCT NAME 3-terminal Feed Through Filter Tape packaging 【RoHS compliant】 YFF18, YFF21, YFF31 Type
-------------------------	-------------------------------------------------------------------------------------------------------------------

Please return this specification to TDK representatives with your signature.
 If orders are placed without returned specification, please allow us to judge that specification is accepted by your side.

RECEIPT CONFIRMATION

DATE: _____ YEAR _____ MONTH _____ DAY _____

Test conditions in this specification based on AEC-Q200 for automotive application.

TDK Corporation
 Sales
 Electronic Components
 Sales & Marketing Group

Engineering
 Electronic Components Business Company

APPROVED	Person in charge

APPROVED	CHECKED	Person in charge

SCOPE

This delivery specification shall be applied to 3-terminal feed through filter to be delivered to _____.

PRODUCTION PLACES

Production places defined in this specification shall be TDK Corporation, TDK(Suzhou)Co.,Ltd and TDK Components U.S.A.,Inc.

PRODUCT NAME

The name of the product to be defined in this specifications shall be YFF◇◇○○○△△□□□M.

COONTENTS

1. CODE CONSTRUCTION
2. RATED CURRENT
3. OPERATING TEMPERATURE RANGE
4. STORING CONDITION AND TERM
5. INDUSTRIAL WASTE DISPOSAL
6. PERFORMANCE
7. INSIDE STRUCTURE AND MATERIAL
8. PACKAGING
9. SOLDERING CONDITION
10. EQUIVALENT CIRCUIT DIAGRAM
11. CAUTION
12. TAPE PACKAGING SPECIFICATION

<EXPLANATORY NOTE>

When the mistrust in the spec arises, this specification is given priority. And it will be confirmed by written spec change after conference of both posts involved.

This specification warrants the quality of the 3-terminal feed through filter. Products should be evaluated or confirmed a state of mounted on your product.

If the use of the products goes beyond the bounds of this specification, we can not afford to guarantee.

Date	SPEC. No.
Jun, 2020	A-YFF-d

1. CODE CONSTRUCTION

(Example)	YFF18	AC	1C	104	M	T	○○○○
	YFF21	AC	1E	104	M	T	<u>○○○○</u>
	<u>YFF31</u>	<u>AH</u>	<u>2A</u>	<u>105</u>	<u>M</u>	<u>T</u>	<u>○○○○</u>
	(1)	(2)	(3)	(4)	(5)	(6)	(7)

(1)Type

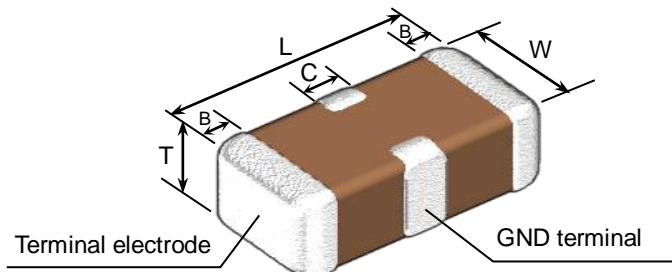

Type	Dimensions (mm)				
	L	W	T	B	C
YFF18	1.60±0.20	0.80±0.15	0.60±0.10	0.25±0.20	0.40±0.20
YFF21	2.00±0.20	1.25±0.20	0.85±0.15	0.30±0.20	0.50+0.30/-0.20
YFF31	3.20±0.20	1.60±0.20	1.30±0.20	0.40±0.30	1.20±0.30

*As for each item, please refer to detail page on TDK web.

(2)Product Classification

Symbol	Product Classification
A C	For Automotive general use
A H	For Automotive Large-current power Line

(3)Rated Voltage

Symbol	Rated Voltage
2 A	DC 100 V
1 H	DC 50 V
1 E	DC 25 V
1 C	DC 16 V
0 J	DC 6.3 V

(4) Rated Capacitance

Stated in three digits and in units of pico farads (pF). The first and Second digits identify the first and second significant figures of the capacitance, the third digit identifies the multiplier.

(Example)

Symbol	Rated Capacitance
104	100,000pF
105	1,000,000pF

(5)Capacitance tolerance

Symbol	Tolerance
M	± 20 %

(6)Packaging

Symbol	Packaging
T	Taping

(7)TDK internal code

2. RATED CURRENT

Rated current depend on operating temperature.
As for details, please refer to detail page on TDK web.

3. OPERATING TEMPERATURE RANGE

Min. operating Temperature	Max. operating Temperature	Reference Temperature
-55°C	125°C	25°C

4. STORING CONDITION AND TERM

Storing temperature	Storing humidity	Storing term
5~40°C	20~70%RH	Within 6 months upon receipt.

5. INDUSTRIAL WASTE DISPOSAL

Dispose this product as industrial waste in accordance with the industrial Waste Law.

6. PERFORMANCE

Table 1

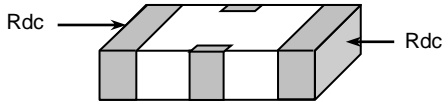
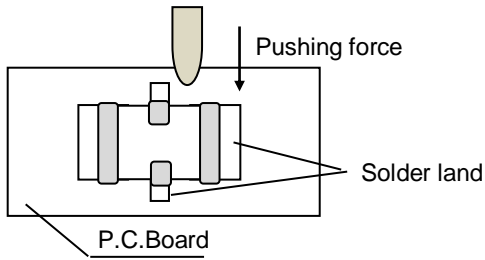
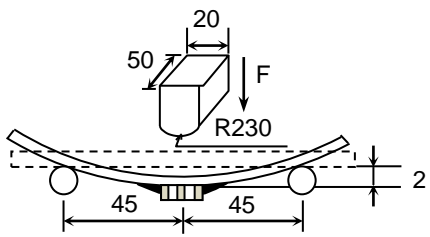
No.	Item	Performance	Test or inspection method
1	External Appearance	No defects which may affect performance.	Inspect with magnifying glass (3×).
2	Insulation Resistance	10,000MΩ or 500MΩ·μF min. (As for the products of rated voltage 16V DC and lower, 100MΩ·μF min.), whichever smaller.	Measuring voltage : Rated voltage Voltage application time : 60s.
3	Direct Current Resistance (Rdc)	Please refer to detail page on TDK web.	Measuring current shall be 100mA max. 
4	Voltage Proof	Withstand test voltage without insulation breakdown or other damage.	Apply voltage : 2.5 × rated voltage Voltage application time : 1s. Charge / discharge current : 50mA or lower
5	Capacitance	Within the specified tolerance.	As for measuring condition, please contact with our sales representative.
6	Robustness of Terminations	No sign of termination coming off, breakage of ceramic, or other abnormal signs.	Reflow solder the products on a P.C.Board shown in Appendix 2. Apply a pushing force gradually to a specimen as shown in the following figure. pushing force : 17.7N. 
7	Bending	External appearance	Reflow solder the products on a P.C.Board shown in Appendix 1 and bend it for 2mm. (1mm is applied for YFF31AH type.)  (Unit : mm)
	Capacitance	Change from the value before test $\pm 12.5\%$	
	Direct current Resistance (Rdc)	Please contact with our sales representative.	

(continued)

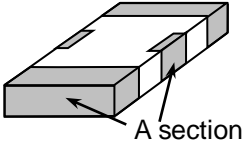
No.	Item	Performance	Test or inspection method						
8	Solderability	<p>New solder to cover over 75% of termination. 25% may have pin holes or rough spots but not concentrated in one spot. Ceramic surface of A sections shall not be exposed due to melting or shifting of termination material.</p> 	<p>Solder : Sn-3.0Ag-0.5Cu</p> <p>Flux : Isopropyl alcohol (JIS K 8839) Rosin (JIS K 5902) 25% solid solution.</p> <p>Solder temp. : 245±5°C</p> <p>Dwell time : 3±0.3s.</p> <p>Solder position : Until both terminations are completely soaked.</p>						
9	Resistance to solder heat	<table border="1"> <tr> <td>External appearance</td> <td>No cracks are allowed and terminations shall be covered at least 60% with new solder.</td> </tr> <tr> <td>Capacitance</td> <td> <p>_____</p> <p>Change from the value before test</p> <p>_____</p> <p>± 7.5 %</p> <p>_____</p> </td> </tr> <tr> <td>Direct current resistance (Rdc)</td> <td>Please contact with our sales representative.</td> </tr> </table>	External appearance	No cracks are allowed and terminations shall be covered at least 60% with new solder.	Capacitance	<p>_____</p> <p>Change from the value before test</p> <p>_____</p> <p>± 7.5 %</p> <p>_____</p>	Direct current resistance (Rdc)	Please contact with our sales representative.	<p>Solder : Sn-3.0Ag-0.5Cu</p> <p>Flux : Isopropyl alcohol (JIS K 8839) Rosin (JIS K 5902) 25% solid solution.</p> <p>Solder temp. : 260±5°C</p> <p>Dwell time : 10±1s.</p> <p>Solder position : Until both terminations are completely soaked.</p> <p>Pre-heating : Temp. — 110~140°C Time — 30~60s.</p> <p>Leave the products in ambient condition for 24±2h before measurement.</p>
External appearance	No cracks are allowed and terminations shall be covered at least 60% with new solder.								
Capacitance	<p>_____</p> <p>Change from the value before test</p> <p>_____</p> <p>± 7.5 %</p> <p>_____</p>								
Direct current resistance (Rdc)	Please contact with our sales representative.								
10	Vibration	<table border="1"> <tr> <td>External appearance</td> <td>No mechanical damage.</td> </tr> <tr> <td>Capacitance</td> <td> <p>_____</p> <p>Change from the value before test</p> <p>_____</p> <p>± 7.5 %</p> <p>_____</p> </td> </tr> <tr> <td>Direct current resistance (Rdc)</td> <td>Please contact with our sales representative.</td> </tr> </table>	External appearance	No mechanical damage.	Capacitance	<p>_____</p> <p>Change from the value before test</p> <p>_____</p> <p>± 7.5 %</p> <p>_____</p>	Direct current resistance (Rdc)	Please contact with our sales representative.	<p>Applied force : 5G max.</p> <p>Frequency : 10~2,000Hz</p> <p>Reciprocating sweep time : 20 min.</p> <p>Cycle : 12 cycles in each 3 mutually perpendicular directions.</p> <p>Reflow solder the products on a P.C.Board shown in Appendix 2 before testing.</p>
External appearance	No mechanical damage.								
Capacitance	<p>_____</p> <p>Change from the value before test</p> <p>_____</p> <p>± 7.5 %</p> <p>_____</p>								
Direct current resistance (Rdc)	Please contact with our sales representative.								

(continued)

No.	Item	Performance	Test or inspection method															
11	Temperature cycle	No mechanical damage.	Expose the products in the condition step1 through step 4 listed in the following table. Temp. cycle : 1,000 cycles <table border="1"> <thead> <tr> <th>Step</th> <th>Temperature(°C)</th> <th>Time (min.)</th> </tr> </thead> <tbody> <tr> <td>1</td> <td>Min. operating temp. ± 3</td> <td>30 ± 3</td> </tr> <tr> <td>2</td> <td>Ambient Temp.</td> <td>2 ~ 5</td> </tr> <tr> <td>3</td> <td>Max. operating temp. ± 2</td> <td>30 ± 2</td> </tr> <tr> <td>4</td> <td>Ambient Temp.</td> <td>2 ~ 5</td> </tr> </tbody> </table> As for Min./ Max. operating temp., please refer to "3.OPERATING TEMPERATURE RANGE". Leave the products in ambient condition for 24 ± 2 h before measurement. Reflow solder the products on a P.C.Board shown in Appendix 2 before testing.	Step	Temperature(°C)	Time (min.)	1	Min. operating temp. ± 3	30 ± 3	2	Ambient Temp.	2 ~ 5	3	Max. operating temp. ± 2	30 ± 2	4	Ambient Temp.	2 ~ 5
	Step	Temperature(°C)		Time (min.)														
	1	Min. operating temp. ± 3		30 ± 3														
	2	Ambient Temp.		2 ~ 5														
3	Max. operating temp. ± 2	30 ± 2																
4	Ambient Temp.	2 ~ 5																
External appearance																		
Capacitance	_____ Change from the value before test _____ Please contact with our sales representative. _____																	
Direct current resistance (Rdc)	Please contact with our sales representative.																	
12	Moisture Resistance (Steady State)	No mechanical damage.	Test temp. : 40 ± 2 °C Test humidity : 90~95%RH Test time : 500 +24,0h Leave the products in ambient condition for 24 ± 2 h before measurement. Reflow solder the products on a P.C.Board shown in Appendix 2 before testing.															
	External appearance																	
	Capacitance	_____ Change from the value before test _____ Please contact with our sales representative. _____																
	Direct current resistance (Rdc)	Please contact with our sales representative.																
Insulation Resistance	1,000M Ω or 50M Ω · μ F min. (As for the products of rated voltage 16V DC and lower, 10M Ω · μ F min.), whichever smaller.																	

(continued)

No.	Item	Performance	Test or inspection method
13	Moisture Resistance	External appearance	No mechanical damage.
		Capacitance	Change from the value before test Please contact with our sales representative.
		Direct current resistance (Rdc)	Please contact with our sales representative.
		Insulation Resistance	500MΩ or 25MΩ·μF min. (As for the products of rated voltage 16V DC and lower, 5MΩ·μF min.), whichever smaller.
			<p>Test temp. : 85±2°C Test humidity : 85%RH Applied voltage : Rated voltage Test time : 1,000 +48,0h</p> <p>Charge/discharge current : 50mA or lower</p> <p>Leave the products in ambient condition for 24±2h before measurement.</p> <p>Reflow solder the products on a P.C.Board shown in Appendix2 before testing.</p> <p>Initial value setting Voltage conditioning «After voltage treat the products under testing temperature and voltage for 1 hour,» leave the products in ambient condition for 24±2h before measurement. Use this measurement for initial value.</p>
14	Life	External appearance	No mechanical damage.
		Capacitance	Change from the value before test Please contact with our sales representative.
		Direct current resistance (Rdc)	Please contact with our sales representative.
		Insulation Resistance	1,000MΩ or 50MΩ·μF min. (As for the products of rated voltage 16V DC and lower, 10MΩ·μF min.), whichever smaller.
			<p>Test temp. : Maximum operating temperature±2°C Applied voltage : Please contact with our sales representative. Test time : 1,000 +48,0h</p> <p>Charge/discharge current : 50mA or lower</p> <p>Leave the products in ambient condition for 24±2h before measurement.</p> <p>Reflow solder the products on a P.C.Board shown in Appendix2 before testing.</p> <p>Initial value setting Voltage conditioning «After voltage treat the products under testing temperature and voltage for 1 hour,» leave the products in ambient condition for 24±2h before measurement. Use this measurement for initial value.</p>

*As for the initial measurement of product on number 7, 9, 10, 11 and 12, leave products at 150 0,-10°C for 1h and measure the value after leaving product for 24±2h in ambient condition.

Appendix 1

P.C.Board for bending test

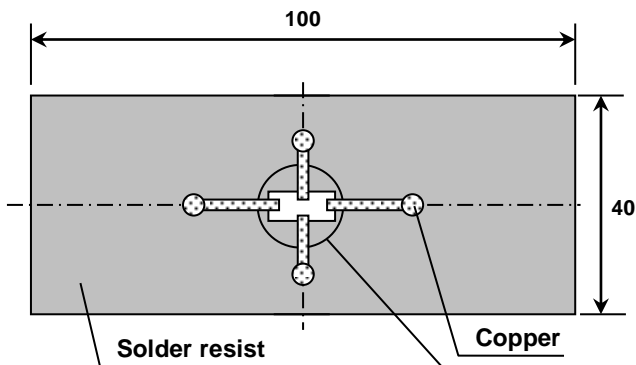

Appendix 2

P.C.Board for reliability test

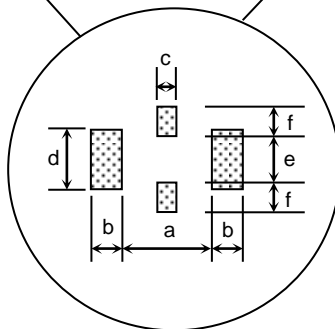
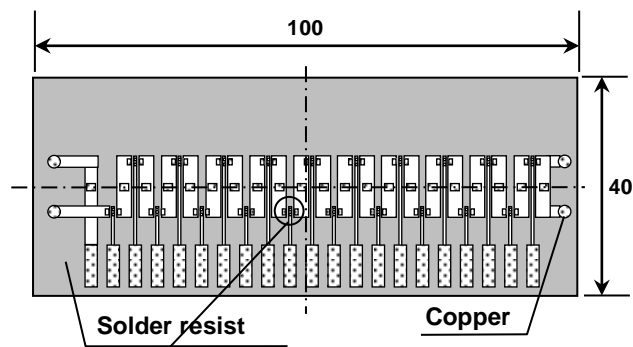



(Unit: mm)

Type	Dimensions					
	a	b	c	d	e	F
YFF18	1.0	0.6	0.4	0.6	0.4	0.4
YFF21	1.4	0.6	0.5	0.8	0.6	0.65
YFF31	2.5	1.2	1.4	1.3	0.8	0.9

1. Material : Glass Epoxy(As per JIS C6484 GE4)

2. Thickness : Appendix 1 — 1.0mm
 : Appendix 2 — 1.6mm

 Copper(Thickness:0.035mm)
 Solder resist

7. INSIDE STRUCTURE AND MATERIAL

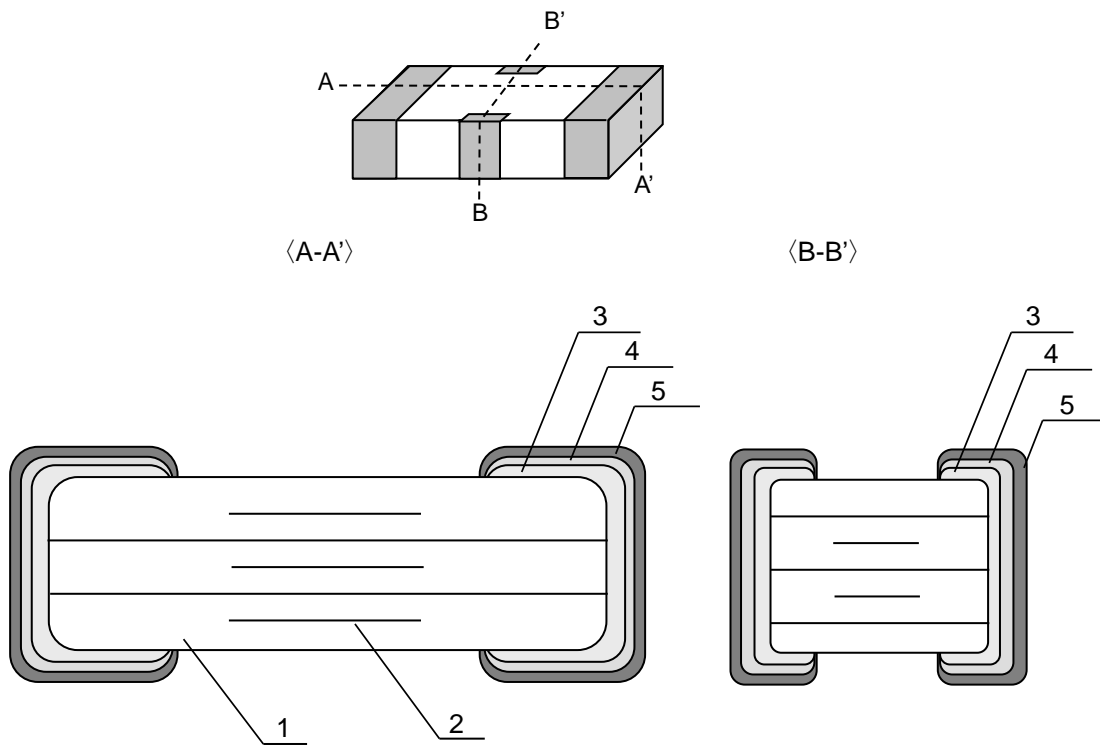

No.	NAME	MATERIAL
1	Dielectric	CaZrO ₃ or BaTiO ₃
2	Electrode	Ni
3	Termination	Cu
4		Ni
5		Sn

8. PACKAGING

Packaging shall be done to protect the components from the damage during transportation and storing, and a label which has the following information shall be attached.
Tape packaging is as per 12. TAPE PACKAGING SPECIFICATION.

- 1) Inspection No.
- 2) TDK P/N
- 3) Customer's P/N
- 4) Quantity

*Composition of Inspection No.

Example F 0 A - 23 - 001
 (a) (b) (c) (d) (e)

- (a) Line code
- (b) Last digit of the year
- (c) Month and A for January and B for February and so on. (Skip I)
- (d) Inspection Date of the month.
- (e) Serial No. of the day

*Composition of new Inspection No.

(Implemented on and after May 1, 2019 in sequence)

Example

I	F	0	E	2	3	A	0	0	1
(a)	(b)	(c)	(d)	(e)	(f)	(g)	(h)	(i)	(j)

- (a) Prefix
- (b) Line code
- (c) Last digit of the year
- (d) Month and A for January and B for February and so on. (Skip I)
- (e) Inspection Date of the month.
- (f) Serial No. of the day(00 ~ ZZ)
- (g) Suffix(00 ~ ZZ)

* It was shifted to the new inspection No. on and after May 2019, but the implementation timing may be different depending on shipment bases.
Until the shift is completed, either current or new composition of inspection No. will be applied.

9. SOLDERING CONDITION

Reflow soldering only.

10. EQUIVALENT CIRCUIT DIAGRAM

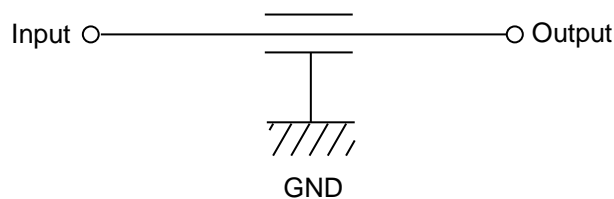
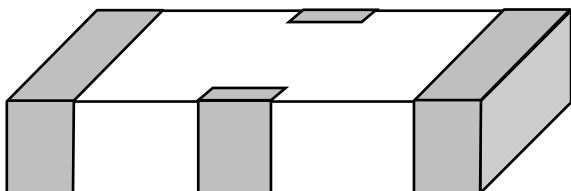

11. CAUTION

No.	Process	Condition
1	Operating Condition (Storage, Use, Transportation)	<p>1-1. Storage, Use</p> <p>The products must be stored in an ambient temperature of 5 to 40°C with a relative humidity of 20 to 70%RH. JIS C 60721-3-1 Class 1K2 should be followed for the other climatic conditions.</p> <ol style="list-style-type: none"> 1) High temperature and humidity environment may affect a product's solder ability because it accelerates terminal oxidization. They also deteriorate performance of taping and packaging. Therefore, SMD products shall be used within 6 months. For products with terminal electrodes consisting of silver or silver-palladium which tend to become oxidized or sulfurized, use as soon as possible, such as within one month after opening the bag. 2) When capacitors are stored for a longer time period than 6 months, confirm the solderability of the capacitors prior to use. During storage, keep the minimum packaging unit in its original packaging without opening it. Do not deviate from the above temperature and humidity conditions even for a short term. 3) Corrosive gasses in the air or atmosphere may result in deterioration of the reliability, such as poor solderability of the terminal electrodes. Do not store products where they will be exposed to corrosive gas (e.g., hydrogen sulfide, sulfur dioxide, chlorine ammonia etc.) 4) Solderability and electrical performance may deteriorate due to photochemical change in the terminal electrode if stored in direct sunlight, or due to condensation from rapid changes in humidity. The products especially which use resin material must be operated and stored in an environment free of dew condensation, as moisture absorption due to condensation may affect the performance. 5) Refer to JIS C 60721-3-1, class 1K2 for other climate conditions. <p>1-2. Handling in transportation</p> <p>In case of the transportation of the products, the performance of the products may be deteriorated depending on the transportation condition. (Refer to JEITA RCR-2335C 9.2 Handling in transportation)</p>
2	Circuit design  Caution	<p>2-1. Operating temperature</p> <ol style="list-style-type: none"> 1) Upper category temperature (maximum operating temperature) is specified. It is necessary to select a product whose rated temperature is higher than the operating temperature. Also, it is necessary to consider the temperature distribution in the equipment and seasonal temperature variation. 2) Do not use products above the maximum allowable operating temperature. Surface temperature including self heating should be below maximum operating temperature. (Due to dielectric loss, products will heat itself when AC is applied. Especially at high frequencies around its SRF, the heat might be so extreme that it may damage itself or the product mounted on. Please design the circuit so that the maximum temperature of the products including the self heating to be below the maximum allowable operating temperature. Temperature rise at product surface shall be below 20°C) 3) The electrical characteristics of the products will vary depending on the temperature. The products should be selected and designed in taking the temperature into consideration. <p>2-2. When overvoltage is applied</p> <p>Applying overvoltage to a product may cause dielectric breakdown and result in a short circuit. The duration until dielectric breakdown depends on the applied voltage and the ambient temperature.</p>

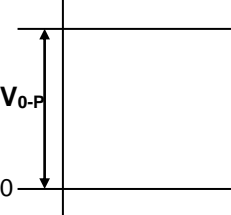
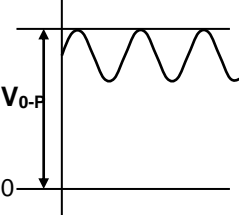
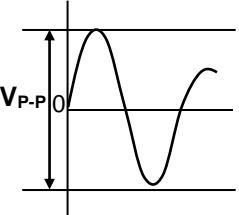
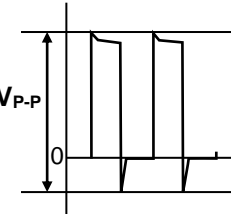
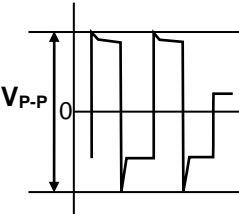
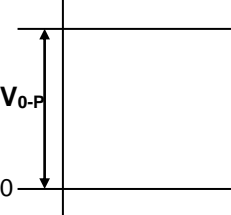
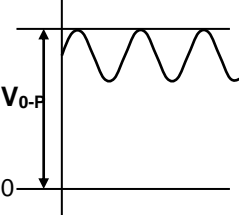
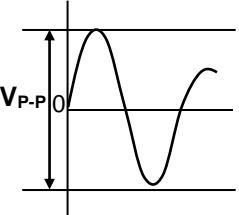
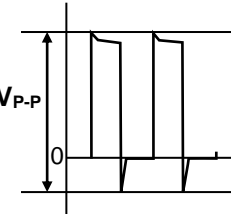
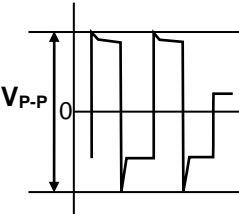
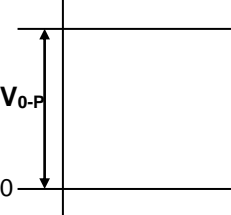
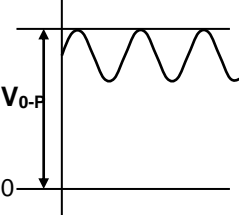
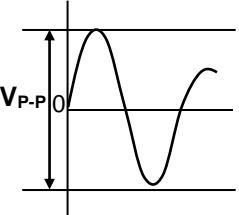
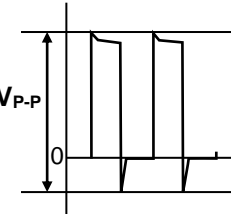
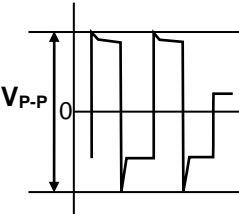
No.	Process	Condition														
2	Circuit design  Caution	<p>2-3. Operating voltage</p> <p>1) Operating voltage across the terminals should be below the rated voltage. When AC and DC are super imposed, V_{0-P} must be below the rated voltage. — (1) and (2)</p> <p>AC or pulse with overshooting, V_{P-P} must be below the rated voltage. — (3), (4) and (5)</p> <p>When the voltage is started to apply to the circuit or it is stopped applying, the irregular voltage may be generated for a transit period because of resonance or switching. Be sure to use the capacitors within rated voltage containing these Irregular voltage.</p> <table border="1" data-bbox="472 521 1449 1097"> <thead> <tr> <th data-bbox="472 521 663 566">Voltage</th> <th data-bbox="663 521 922 566">(1) DC voltage</th> <th data-bbox="922 521 1182 566">(2) DC+AC voltage</th> <th data-bbox="1182 521 1449 566">(3) AC voltage</th> </tr> </thead> <tbody> <tr> <td data-bbox="472 566 663 795">Positional Measurement (Rated voltage)</td> <td data-bbox="663 566 922 795">  </td> <td data-bbox="922 566 1182 795">  </td> <td data-bbox="1182 566 1449 795">  </td> </tr> <tr> <th data-bbox="472 824 663 869">Voltage</th> <th data-bbox="663 824 922 869">(4) Pulse voltage (A)</th> <th data-bbox="922 824 1182 869">(5) Pulse voltage (B)</th> </tr> <tr> <td data-bbox="472 869 663 1097">Positional Measurement (Rated voltage)</td> <td data-bbox="663 869 922 1097">  </td> <td data-bbox="922 869 1182 1097">  </td> </tr> </tbody> </table> <p>2) Even below the rated voltage, if repetitive high frequency AC or pulse is applied, the reliability of the products may be reduced.</p> <p>3) The effective capacitance will vary depending on applied DC and AC voltages. The products should be selected and designed in taking the voltages into consideration.</p> <p>4) Abnormal voltage (surge voltage, static electricity, pulse voltage, etc.) shall not exceed the rated voltage.</p> <p>5) When products are used in a series connection, it is necessary to add a balancing circuit such as voltage dividing resistors in order to avoid an imbalance in the voltage applied to each product.</p> <p>2-3. Frequency When the products are used in AC and/or pulse voltages, the capacitors may vibrate themselves and generate audible sound.</p>	Voltage	(1) DC voltage	(2) DC+AC voltage	(3) AC voltage	Positional Measurement (Rated voltage)				Voltage	(4) Pulse voltage (A)	(5) Pulse voltage (B)	Positional Measurement (Rated voltage)		
Voltage	(1) DC voltage	(2) DC+AC voltage	(3) AC voltage													
Positional Measurement (Rated voltage)																
Voltage	(4) Pulse voltage (A)	(5) Pulse voltage (B)														
Positional Measurement (Rated voltage)																

No.	Process	Condition																												
3	Designing P.C.board	<p>The amount of solder at the terminations has a direct effect on the reliability of the products.</p> <ol style="list-style-type: none"> 1) The greater the amount of solder, the higher the stress on the products, and the more likely that it will break. When designing a P.C.board, determine the shape and size of the solder lands to have proper amount of solder on the terminations. 2) Avoid using common solder land for multiple terminations and provide individual solder land for each terminations. 3) Size and recommended land dimensions. <p>Chip mounted size</p> <p> Resist Land pattern Land pattern & Resist </p> <p>YFF Series is having the unique Ground structure and eliminate unnecessary noise at the wide frequency range. The following points should be considered at the pad design to obtain the better performance.</p> <ol style="list-style-type: none"> 1) Ground pattern should be designed as big as possible. 2) Make through hole and connect to the ground pattern of the chip mounted side. 3) Through hole should be designed as close to GND terminal as possible. <p>Notes) *If through hole is too big, solder paste way came into the hole and make bad connection with the ground pattern.</p> <p style="text-align: right;">(mm)</p> <table border="1" style="width: 100%; border-collapse: collapse;"> <thead> <tr> <th style="text-align: center;">Symbol</th> <th style="text-align: center;">a</th> <th style="text-align: center;">b</th> <th style="text-align: center;">c</th> <th style="text-align: center;">d</th> <th style="text-align: center;">e</th> <th style="text-align: center;">f</th> </tr> </thead> <tbody> <tr> <td style="text-align: center;">YFF18</td> <td style="text-align: center;">1.00</td> <td style="text-align: center;">0.60</td> <td style="text-align: center;">0.40</td> <td style="text-align: center;">0.60</td> <td style="text-align: center;">0.40</td> <td style="text-align: center;">0.40</td> </tr> <tr> <td style="text-align: center;">YFF21</td> <td style="text-align: center;">1.40</td> <td style="text-align: center;">0.60</td> <td style="text-align: center;">0.50</td> <td style="text-align: center;">0.80</td> <td style="text-align: center;">0.60</td> <td style="text-align: center;">0.65</td> </tr> <tr> <td style="text-align: center;">YFF31</td> <td style="text-align: center;">2.50</td> <td style="text-align: center;">1.20</td> <td style="text-align: center;">1.40</td> <td style="text-align: center;">1.30</td> <td style="text-align: center;">0.80</td> <td style="text-align: center;">0.90</td> </tr> </tbody> </table>	Symbol	a	b	c	d	e	f	YFF18	1.00	0.60	0.40	0.60	0.40	0.40	YFF21	1.40	0.60	0.50	0.80	0.60	0.65	YFF31	2.50	1.20	1.40	1.30	0.80	0.90
Symbol	a	b	c	d	e	f																								
YFF18	1.00	0.60	0.40	0.60	0.40	0.40																								
YFF21	1.40	0.60	0.50	0.80	0.60	0.65																								
YFF31	2.50	1.20	1.40	1.30	0.80	0.90																								

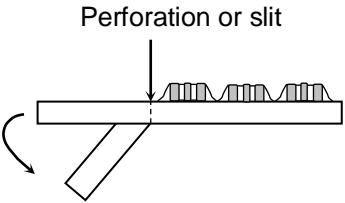
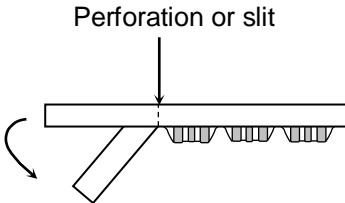
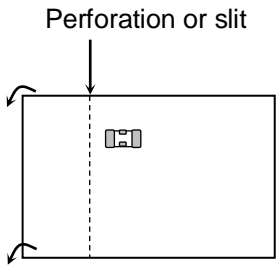
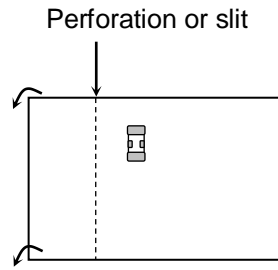
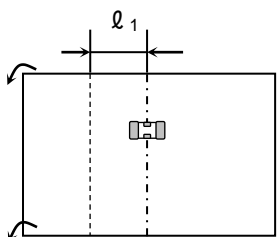
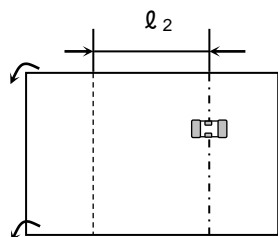
No.	Process	Condition		
3	Designing P.C.board	4) Recommended product layout is as following.		
			Disadvantage against bending stress	Advantage against bending stress
		Mounting face	<p>Perforation or slit</p>  <p>Break P.C.board with mounted side up.</p>	<p>Perforation or slit</p>  <p>Break P.C.board with mounted side down.</p>
		Chip arrangement (Direction)	<p>Mount perpendicularly to perforation or slit</p> <p>Perforation or slit</p> 	<p>Mount in parallel with perforation or slit</p> <p>Perforation or slit</p> 
		Distance from slit	<p>Closer to slit is higher stress</p>  <p>($l_1 < l_2$)</p>	<p>Away from slit is less stress</p>  <p>($l_1 < l_2$)</p>

No.	Process	Condition									
3	Designing P.C.board	<p>5) Mechanical stress varies according to location of chip capacitors on the P.C.board.</p> <div data-bbox="427 297 1404 862" style="border: 1px solid black; padding: 10px;"> <p style="text-align: right;">Stress force $A > B > E$ $A > D > E$ $A > C$</p> </div> <p>When dividing printed wiring boards, the intensities of mechanical stress applied to products are different according to each dividing method in the order of : Push-back < Slit < V-groove < Perforation. Therefore consider not only position of products, but also the way of the dividing the printed wiring boards.</p> <p>6) Layout recommendation</p> <table border="1" style="width: 100%; border-collapse: collapse;"> <thead> <tr> <th data-bbox="384 1108 603 1227">Example</th> <th data-bbox="603 1108 1045 1227">Use of common solder land</th> <th data-bbox="1045 1108 1484 1227">Soldering with chassis</th> </tr> </thead> <tbody> <tr> <td data-bbox="384 1227 603 1608">Need to avoid</td> <td data-bbox="603 1227 1045 1608"> </td> <td data-bbox="1045 1227 1484 1608"> </td> </tr> <tr> <td data-bbox="384 1608 603 2022">Recommendation</td> <td data-bbox="603 1608 1045 2022"> </td> <td data-bbox="1045 1608 1484 2022"> <p style="text-align: right;">$l_2 > l_1$</p> </td> </tr> </tbody> </table>	Example	Use of common solder land	Soldering with chassis	Need to avoid			Recommendation		<p style="text-align: right;">$l_2 > l_1$</p>
Example	Use of common solder land	Soldering with chassis									
Need to avoid											
Recommendation		<p style="text-align: right;">$l_2 > l_1$</p>									

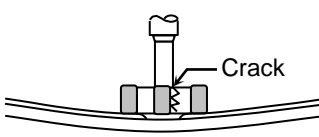
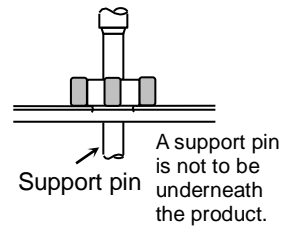
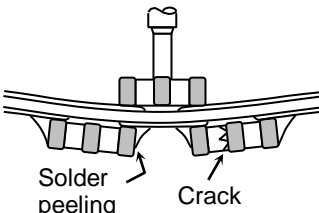
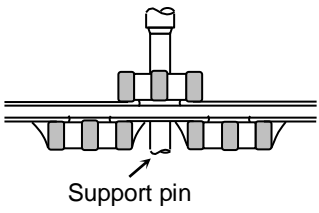
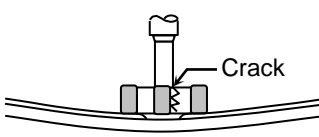
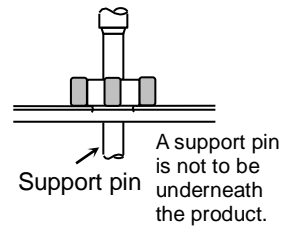
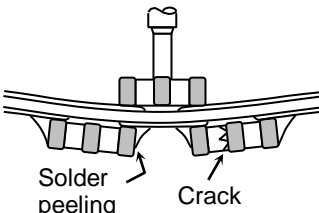
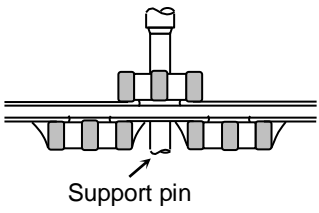
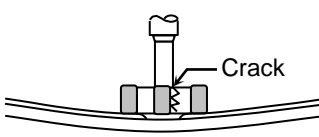
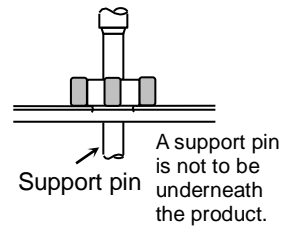
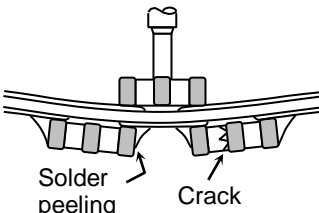
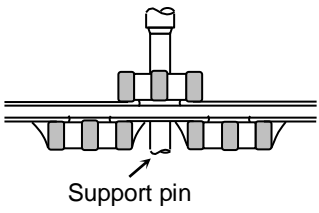
No.	Process	Condition									
4	Mounting	<p>4-1. Stress from mounting head</p> <p>If the mounting head is adjusted too low, it may induce excessive stress in the product to result in cracking. Please take following precautions.</p> <ol style="list-style-type: none"> 1) Adjust the bottom dead center of the mounting head to reach on the P.C.board surface and not press it. 2) Adjust the mounting head pressure to be 1 to 3N of static weight. 3) To minimize the impact energy from mounting head, it is important to provide support from the bottom side of the P.C.board. <p>See following examples.</p> <table border="1" style="width: 100%; border-collapse: collapse;"> <thead> <tr> <th style="width: 30%;"></th> <th style="width: 35%;">Not recommended</th> <th style="width: 35%;">Recommended</th> </tr> </thead> <tbody> <tr> <td style="text-align: center; vertical-align: middle;">Single sided mounting</td> <td style="text-align: center;">  <p>Crack</p> </td> <td style="text-align: center;">  <p>Support pin</p> <p>A support pin is not to be underneath the product.</p> </td> </tr> <tr> <td style="text-align: center; vertical-align: middle;">Double-sides mounting</td> <td style="text-align: center;">  <p>Solder peeling</p> <p>Crack</p> </td> <td style="text-align: center;">  <p>Support pin</p> </td> </tr> </tbody> </table> <p>When the centering jaw is worn out, it may give mechanical impact on the product to cause crack. Please control the close up dimension of the centering jaw and provide sufficient preventive maintenance and replacement of it.</p>		Not recommended	Recommended	Single sided mounting	 <p>Crack</p>	 <p>Support pin</p> <p>A support pin is not to be underneath the product.</p>	Double-sides mounting	 <p>Solder peeling</p> <p>Crack</p>	 <p>Support pin</p>
	Not recommended	Recommended									
Single sided mounting	 <p>Crack</p>	 <p>Support pin</p> <p>A support pin is not to be underneath the product.</p>									
Double-sides mounting	 <p>Solder peeling</p> <p>Crack</p>	 <p>Support pin</p>									

No.	Process	Condition																		
5	Soldering	<p>5-1. Flux selection</p> <p>Flux can seriously affect the performance of products. Confirm the following to select the appropriate flux.</p> <ol style="list-style-type: none"> 1) It is recommended to use a mildly activated rosin flux (less than 0.1wt% chlorine). Strong flux is not recommended. 2) Excessive flux must be avoided. Please provide proper amount of flux. 3) When water-soluble flux is used, enough washing is necessary. <p>5-2. Recommended Reflow soldering profile</p> <div style="text-align: center;"> </div> <p>5-3. Recommended soldering peak temp and peak temp duration for Reflow soldering</p> <p>Pb free solder is recommended, but if Sn-37Pb must be used, refer to below.</p> <table border="1" style="margin-left: auto; margin-right: auto;"> <thead> <tr> <th rowspan="2" style="text-align: center;">Temp./Duration</th> <th colspan="2" style="text-align: center;">Reflow soldering</th> </tr> <tr> <th style="text-align: center;">Peak temp(°C)</th> <th style="text-align: center;">Duration(sec.)</th> </tr> </thead> <tbody> <tr> <td style="text-align: center;">Solder</td> <td></td> <td></td> </tr> <tr> <td style="text-align: center;">Lead Free Solder</td> <td style="text-align: center;">260 max.</td> <td style="text-align: center;">10 max.</td> </tr> <tr> <td style="text-align: center;">Sn-Pb Solder</td> <td style="text-align: center;">230 max.</td> <td style="text-align: center;">20 max.</td> </tr> </tbody> </table> <p>Recommended solder compositions Lead Free Solder : Sn-3.0Ag-0.5Cu</p> <p>5-4. Avoiding thermal shock</p> <ol style="list-style-type: none"> 1) Preheating condition <table border="1" style="margin-left: auto; margin-right: auto;"> <thead> <tr> <th style="text-align: center;">Soldering</th> <th style="text-align: center;">Temp. (°C)</th> </tr> </thead> <tbody> <tr> <td style="text-align: center;">Reflow soldering</td> <td style="text-align: center;">$\Delta T \leq 150$</td> </tr> </tbody> </table> 2) Cooling condition <p>Natural cooling using air is recommended. If the product is dipped into a solvent for cleaning, the temperature difference (ΔT) must be less than 100°C.</p> 	Temp./Duration	Reflow soldering		Peak temp(°C)	Duration(sec.)	Solder			Lead Free Solder	260 max.	10 max.	Sn-Pb Solder	230 max.	20 max.	Soldering	Temp. (°C)	Reflow soldering	$\Delta T \leq 150$
Temp./Duration	Reflow soldering																			
	Peak temp(°C)	Duration(sec.)																		
Solder																				
Lead Free Solder	260 max.	10 max.																		
Sn-Pb Solder	230 max.	20 max.																		
Soldering	Temp. (°C)																			
Reflow soldering	$\Delta T \leq 150$																			

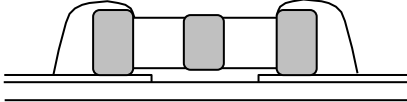
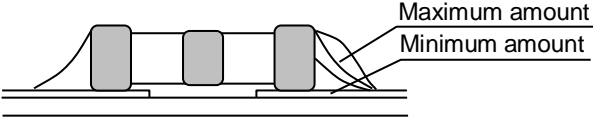
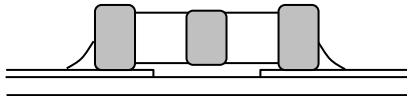
No.	Process	Condition
5	Soldering	<p>5-5. Amount of solder</p> <p>Excessive solder will induce higher tensile force in product when temperature changes and it may result in chip cracking. In sufficient solder may detach the product from the P.C.board.</p> <hr/> <div style="display: flex; justify-content: space-between;"> <div data-bbox="491 421 619 488">Excessive solder</div> <div data-bbox="683 405 1091 506">  </div> <div data-bbox="1118 421 1398 488">Higher tensile force in product to cause crack</div> </div> <hr/> <div style="display: flex; justify-content: space-between;"> <div data-bbox="491 591 612 622">Adequate</div> <div data-bbox="683 546 1278 663">  </div> </div> <hr/> <div style="display: flex; justify-content: space-between;"> <div data-bbox="491 725 628 792">Insufficient solder</div> <div data-bbox="683 725 1091 819">  </div> <div data-bbox="1118 696 1406 819">Low robustness may cause contact failure or product come off the P.C.board.</div> </div> <hr/> <p>5-6. Sn-Zn solder Sn-Zn solder affects product reliability. Please contact TDK in advance when utilize Sn-Zn solder.</p> <p>5-7. Countermeasure for tombstone The misalignment between the mounted positions of the products and the land patterns should be minimized. The tombstone phenomenon may occur especially the products are mounted (in longitudinal direction) in the same direction of the reflow soldering. (Refer to JEITA RCR-2335C Annex A (Informative) Recommendations to prevent the tombstone phenomenon)</p>

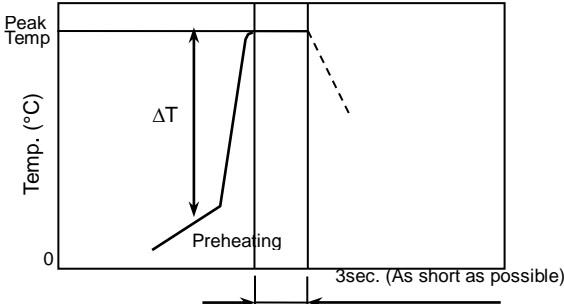
No.	Process	Condition												
6	Solder repairing	<p>6-1. Solder repair by solder iron</p> <p>1) Selection of the soldering iron tip Tip temperature of solder iron varies by its type, P.C.board material and solder land size. The higher the tip temperature, the quicker the operation. However, heat shock may cause a crack in the chip capacitors. Please make sure the tip temp. before soldering and keep the peak temp and time in accordance with following recommended condition.</p> <div style="text-align: center;"> <p>Manual soldering (Solder iron)</p>  </div> <p style="text-align: center;">Recommended solder iron condition (Sn-Pb Solder and Lead Free Solder)</p> <table border="1" style="margin-left: auto; margin-right: auto;"> <thead> <tr> <th>Temp. (°C)</th> <th>Duration (sec.)</th> <th>Wattage (W)</th> <th>Shape (mm)</th> </tr> </thead> <tbody> <tr> <td>350 max.</td> <td>3 max.</td> <td>20 max.</td> <td>∅ 3.0 max.</td> </tr> </tbody> </table> <p>* Please preheat the products with the condition in 5-4 to avoid the thermal shock.</p> <p>2) Direct contact of the soldering iron with ceramic dielectric of products may cause crack. Do not touch the ceramic dielectric and the terminations by solder iron.</p> <p>6-2. Avoiding thermal shock</p> <p>Preheating condition</p> <table border="1" style="margin-left: auto; margin-right: auto;"> <thead> <tr> <th>Soldering</th> <th>Temp. (°C)</th> </tr> </thead> <tbody> <tr> <td>Manual soldering</td> <td>$\Delta T \leq 150$</td> </tr> </tbody> </table>	Temp. (°C)	Duration (sec.)	Wattage (W)	Shape (mm)	350 max.	3 max.	20 max.	∅ 3.0 max.	Soldering	Temp. (°C)	Manual soldering	$\Delta T \leq 150$
Temp. (°C)	Duration (sec.)	Wattage (W)	Shape (mm)											
350 max.	3 max.	20 max.	∅ 3.0 max.											
Soldering	Temp. (°C)													
Manual soldering	$\Delta T \leq 150$													

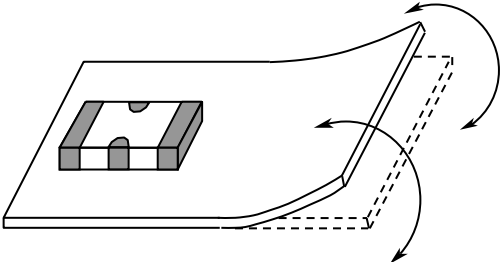
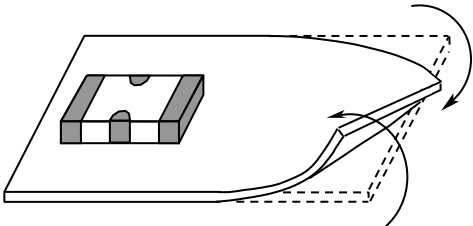
No.	Process	Condition
7	Cleaning	<p>1) If an unsuitable cleaning fluid is used, flux residue or some foreign articles may stick to product surface to deteriorate especially the insulation resistance.</p> <p>2) If cleaning condition is not suitable, it may damage the product.</p> <p>2)-1. Insufficient washing</p> <p>(1) Terminal electrodes may corrode by Halogen in the flux.</p> <p>(2) Halogen in the flux may adhere on the surface of product, and lower the insulation resistance.</p> <p>(3) Water soluble flux has higher tendency to have above mentioned problems (1) and (2).</p> <p>2)-2. Excessive washing</p> <p>When ultrasonic cleaning is used, excessively high ultrasonic energy output can affect the connection between the ceramic product body and the terminal electrode. To avoid this, following is the recommended condition.</p> <p style="text-align: center;">Power : 20 W/l max. Frequency : 40 kHz max. Washing time : 5 minutes max.</p> <p>2)-3. If the cleaning fluid is contaminated, density of Halogen increases, and it may bring the same result as insufficient cleaning.</p>
8	Coating and molding of the P.C.board	<p>1) When the P.C.board is coated, please verify the quality influence on the product.</p> <p>2) Please verify carefully that there is no harmful decomposing or reaction gas emission during curing which may damage the product.</p> <p>3) Please verify the curing temperature.</p>
9	Handling after chip mounted  Caution	<p>1) Please pay attention not to bend or distort the P.C.board after soldering in handling otherwise the product may crack.</p> <div style="display: flex; justify-content: space-around; align-items: center;"> <div style="text-align: center;"> <p>Bend</p>  </div> <div style="text-align: center;"> <p>Twist</p>  </div> </div>

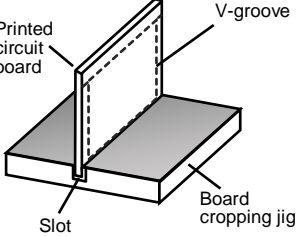
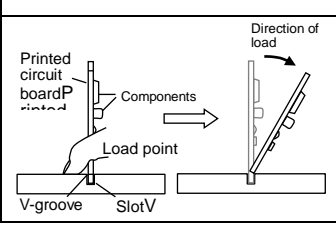
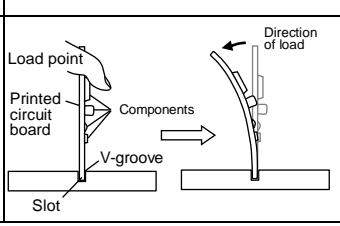
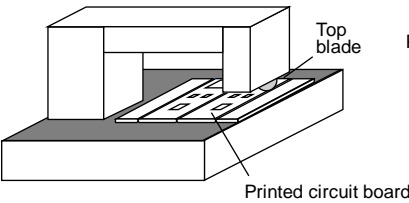
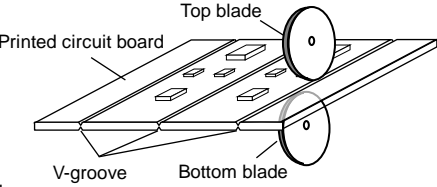
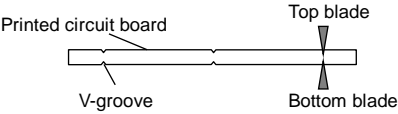
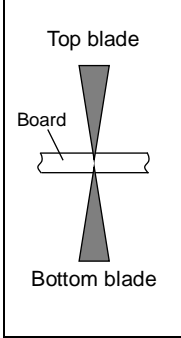
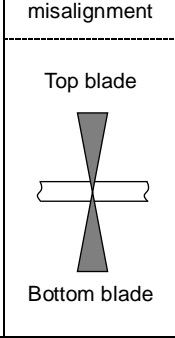
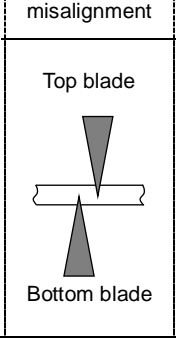
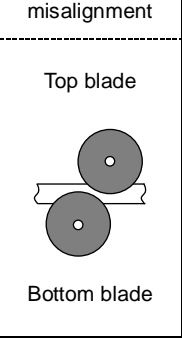
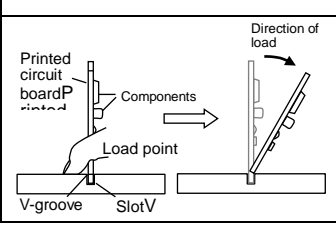
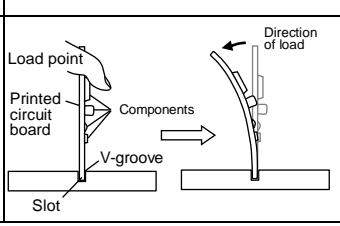
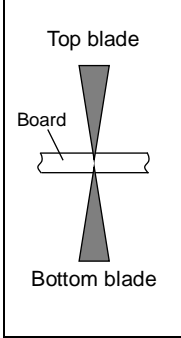
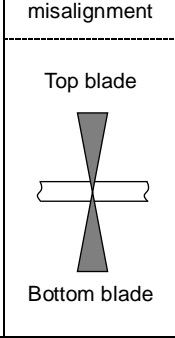
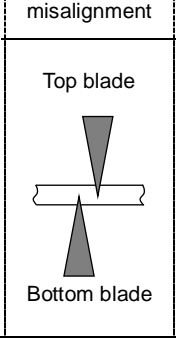
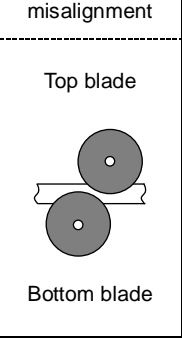
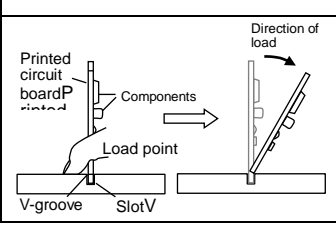
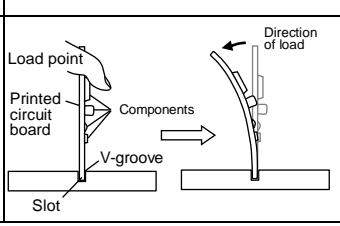
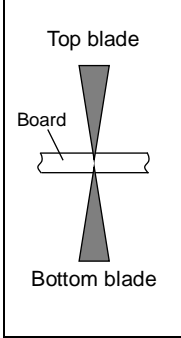
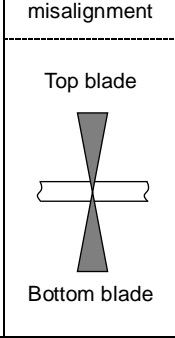
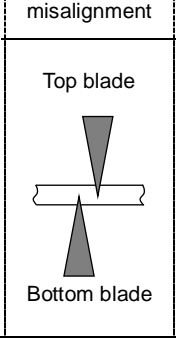
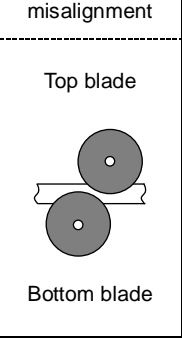
No.	Process	Condition																
9	Handling after chip mounted  Caution	<p>2) Printed circuit board cropping should not be carried out by hand, but by using the proper tooling. Printed circuit board cropping should be carried out using a board cropping jig as shown in the following figure or a board cropping apparatus to prevent inducing mechanical stress on the board.</p> <p>(1) Example of a board cropping jig Recommended example: The board should be pushed from the back side, close to the cropping jig so that the board is not bent and the stress applied to the product is compressive. Unrecommended example: If the pushing point is far from the cropping jig and the pushing direction is from the front side of the board, large tensile stress is applied to the product, which may cause cracks.</p> <div style="display: flex; justify-content: space-around;"> <div data-bbox="475 600 774 880"> <p>Outline of jig</p>  </div> <div data-bbox="778 589 1455 853"> <table border="1"> <thead> <tr> <th data-bbox="778 589 1114 629">Recommended</th> <th data-bbox="1114 589 1455 629">Unrecommended</th> </tr> </thead> <tbody> <tr> <td data-bbox="778 629 1114 853">  </td> <td data-bbox="1114 629 1455 853">  </td> </tr> </tbody> </table> </div> </div> <p>(2) Example of a board cropping machine An outline of a printed circuit board cropping machine is shown below. The top and bottom blades are aligned with one another along the lines with the V-grooves on printed circuit board when cropping the board. Unrecommended example: Misalignment of blade position between top and bottom, right and left, or front and rear blades may cause a crack in the product.</p> <div style="display: flex; justify-content: space-around;"> <div data-bbox="544 1173 954 1429"> <p>Outline of machine</p>  </div> <div data-bbox="954 1173 1393 1413"> <p>Principle of operation</p>  </div> </div> <div style="text-align: center; margin-top: 10px;"> <p>Cross-section diagram</p>  </div> <table border="1" style="width: 100%; text-align: center; margin-top: 20px;"> <thead> <tr> <th data-bbox="655 1659 836 1704">Recommended</th> <th colspan="3" data-bbox="836 1659 1369 1704">Unrecommended</th> </tr> <tr> <th data-bbox="655 1704 836 1749"></th> <th data-bbox="836 1704 1011 1749">Top-bottom misalignment</th> <th data-bbox="1011 1704 1187 1749">Left-right misalignment</th> <th data-bbox="1187 1704 1369 1749">Front-rear misalignment</th> </tr> </thead> <tbody> <tr> <td data-bbox="655 1749 836 2085">  </td> <td data-bbox="836 1749 1011 2085">  </td> <td data-bbox="1011 1749 1187 2085">  </td> <td data-bbox="1187 1749 1369 2085">  </td> </tr> </tbody> </table>	Recommended	Unrecommended			Recommended	Unrecommended				Top-bottom misalignment	Left-right misalignment	Front-rear misalignment				
Recommended	Unrecommended																	
																		
Recommended	Unrecommended																	
	Top-bottom misalignment	Left-right misalignment	Front-rear misalignment															
																		

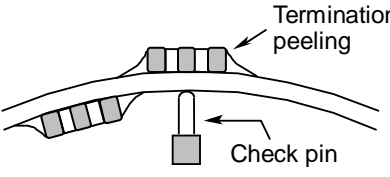
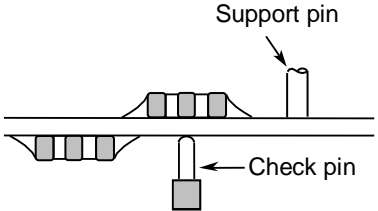
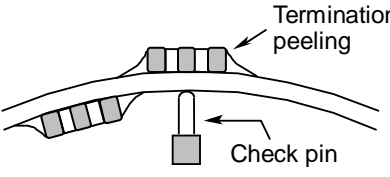
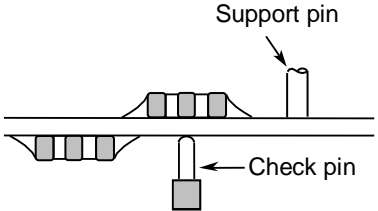
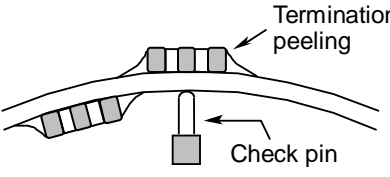
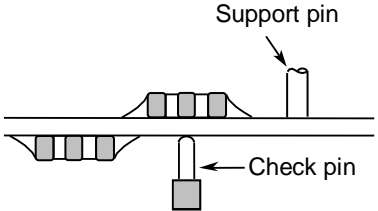
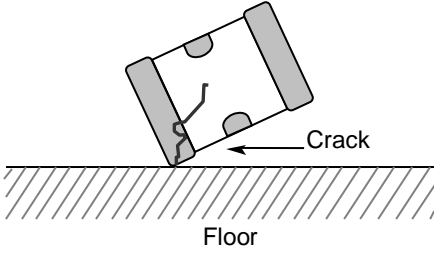
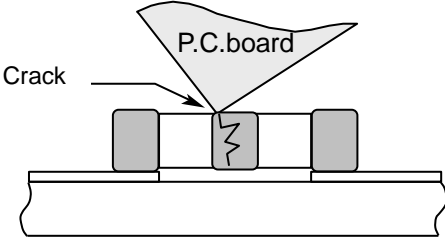
No.	Process	Condition						
9	Handling after chip mounted  Caution	<p data-bbox="475 208 1465 349">3) When functional check of the P.C.board is performed, check pin pressure tends to be adjusted higher for fear of loose contact. But if the pressure is excessive and bend the P.C.board, it may crack the product or peel the terminations off. Please adjust the check pins not to bend the P.C.board.</p> <table border="1" data-bbox="475 405 1437 763"> <thead> <tr> <th data-bbox="475 405 616 465">Item</th> <th data-bbox="616 405 1035 465">Not recommended</th> <th data-bbox="1035 405 1437 465">Recommended</th> </tr> </thead> <tbody> <tr> <td data-bbox="475 465 616 763">Board bending</td> <td data-bbox="616 465 1035 763">  </td> <td data-bbox="1035 465 1437 763">  </td> </tr> </tbody> </table>	Item	Not recommended	Recommended	Board bending		
Item	Not recommended	Recommended						
Board bending								
10	Handling of loose product	<p data-bbox="467 808 1465 920">1) If dropped the product may crack. Once dropped do not use it. Especially, the large case sized product are tendency to have cracks easily, so please handle with care.</p> <div data-bbox="730 925 1166 1178" style="text-align: center;">  <p data-bbox="930 1149 991 1171">Floor</p> </div> <p data-bbox="467 1211 1465 1283">2) Piling the P.C.board after mounting for storage or handling, the corner of the P.C. board may hit the product of another board to cause crack.</p> <div data-bbox="727 1305 1174 1541" style="text-align: center;">  </div>						

No.	Process	Condition
10	Caution during operation of equipment	<p>1) A product shall not be touched directly with bare hands during operation in order to avoid electric shock. Electric energy held by the product may be discharged through the human body when touched with a bare hand. Even when the equipment is off, a product may stay charged. The product should be handled after being completely discharged using a resistor.</p> <p>2) The terminals of a product shall not be short-circuited by any accidental contact with a conductive object. A product shall not be exposed to a conductive liquid such as an acid or alkali solution. A conductive object or liquid, such as acid and alkali, between the terminals may lead to the breakdown of a product due to short circuit</p> <p>3) Confirm that the environment to which the equipment will be exposed during transportation and operation meets the specified conditions. Do not to use the equipment in the following environments.</p> <p>(1) Environment where a product is splattered with water or oil (2) Environment where a product is exposed to direct sunlight (3) Environment where a product is exposed to Ozone, ultraviolet rays or radiation (4) Environment where a product exposed to corrosive gas(e.g. hydrogen sulfide, sulfur dioxide, chlorine, ammonia gas etc.) (5) Environment where a product exposed to vibration or mechanical shock exceeding the specified limits. (6) Atmosphere change with causes condensation</p>
12	Others  Caution	<p>The product listed in this specification is intended for use in automotive applications under-normal operation and usage conditions.</p> <p>The product is not designed or warranted to meet the requirements of application listed below, whose performance and/or quality requires a more stringent level of safety or reliability, or whose failure, malfunction or defect could cause serious damage to society, person or property. Please understand that we are not responsible for any damage or liability caused by use of the products in any of the applications below or for any other use exceeding the range or conditions set forth in this specification sheet. If you intend to use the products in the applications listed below or if you have special requirements exceeding the range or conditions set forth in this specification, please contact us.</p> <p>(1) Aerospace/Aviation equipment (2) Transportation equipment (electric trains, ships etc.) (3) Medical equipment (Excepting Pharmaceutical Affairs Law classification Class1, 2) (4) Power-generation control equipment (5) Atomic energy-related equipment (6) Seabed equipment (7) Transportation control equipment (8) Public information-processing equipment (9) Military equipment (10) Electric heating apparatus, burning equipment (11) Disaster prevention/crime prevention equipment (12) Safety equipment (13) Other applications that are not considered general-purpose applications</p> <p>When designing your equipment even for general-purpose applications, you are kindly requested to take into consideration securing protection circuit/device or providing backup circuits in your equipment.</p> <p>In addition, although the product listed in this specification is intended for use in automotive applications as described above, it is not prohibited to use for general electronic equipment, whose performance and/or quality doesn't require a more stringent level of safety or reliability, or whose failure, malfunction or defect could not cause serious damage to society, person or property.</p> <p>Therefore, the description of this caution will be applied, when the product is used in general electronic equipment under a normal operation and usage conditions.</p>

12. TAPE PACKAGING SPECIFICATION

1. CONSTRUCTION AND DIMENSION OF TAPING

1-1. Dimensions of carrier tape

Dimensions of paper tape shall be according to Appendix 3.

Dimensions of plastic tape shall be according to Appendix 4.

1-2. Bulk part and leader of taping

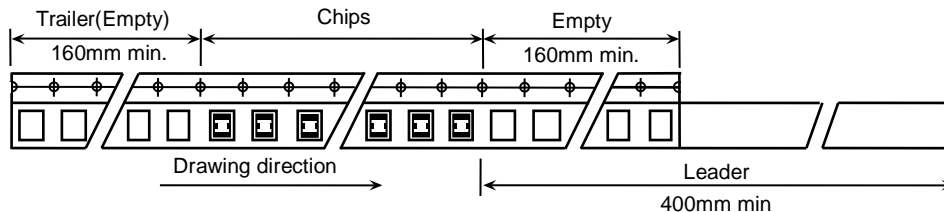

1-3. Dimensions of reel

Dimensions of $\phi 178$ reel shall be according to Appendix 5.

Dimensions of $\phi 330$ reel shall be according to Appendix 6.

1-4. Structure of taping

<Paper>

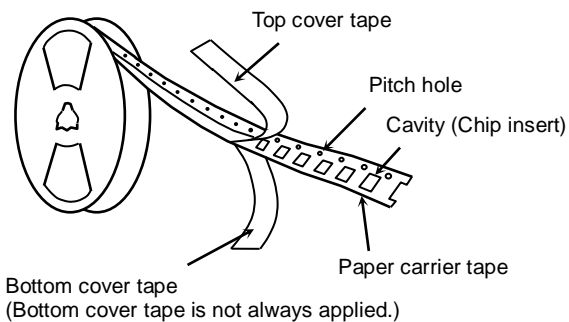

<Plastic>

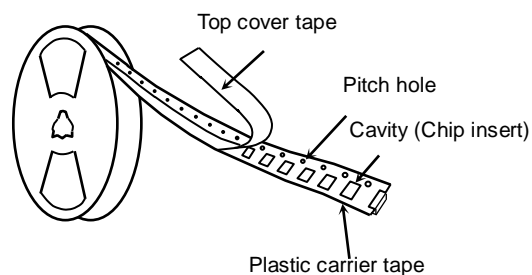

2. PRODUCT QUANTITY

Please refer to detail page on TDK web.

3. PERFORMANCE SPECIFICATIONS

- 3-1. Fixing peeling strength (top tape)
 $0.05\text{N} < \text{Peeling strength} < 0.7\text{N}$

〈Paper〉

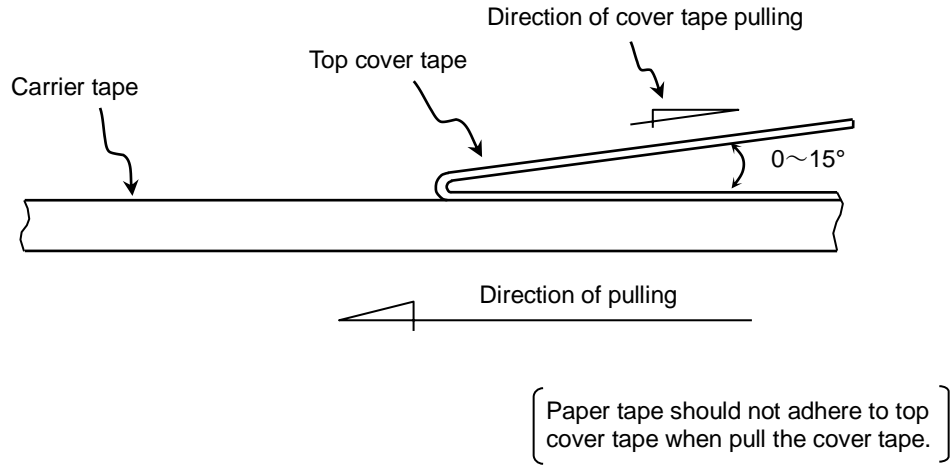

〈Plastic〉

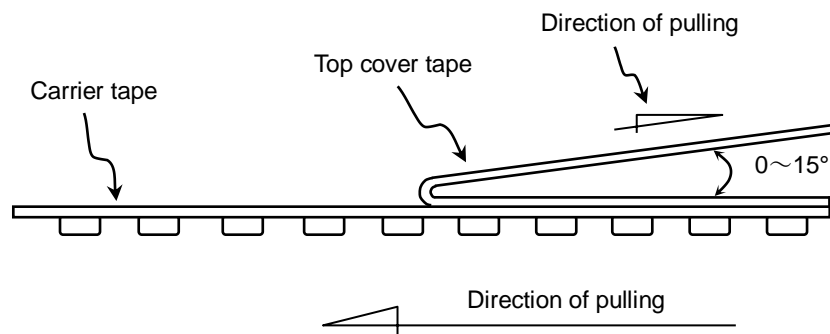

- 3-2. Carrier tape shall be flexible enough to be wound around a minimum radius of 30mm with components in tape.
- 3-3. The missing of components shall be less than 0.1%
- 3-4. Components shall not stick to fixing tape.
- 3-5. When removing the cover tape, there shall not be difficulties by unfitting clearance gap, burrs and crushes of cavities. Also the sprocket holes shall not be covered by absorbing dust into the suction nozzle.

Appendix 3

Paper Tape

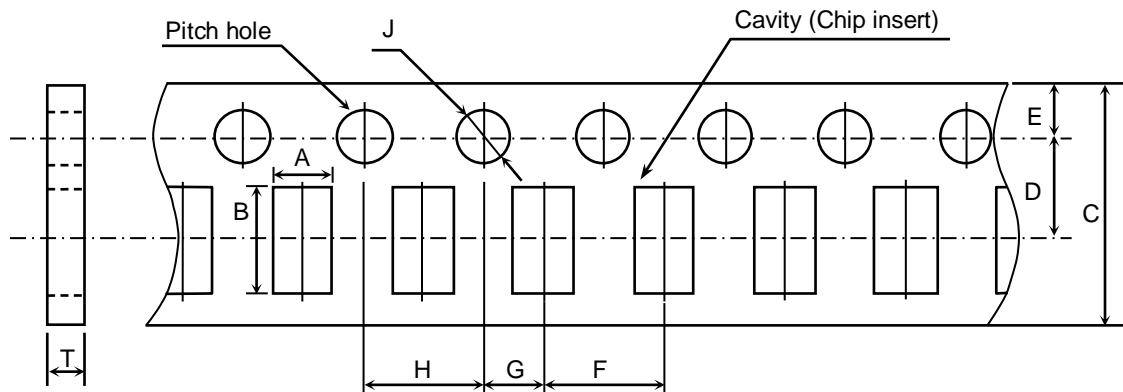

(Unit : mm)

Symbol Type	A	B	C	D	E	F
YFF18	(1.10)	(1.90)	8.00 ± 0.30	3.50 ± 0.05	1.75 ± 0.10	4.00 ± 0.10
YFF21	(1.50)	(2.30)				

Symbol Type	G	H	J	T
YFF18	2.00 ± 0.05	4.00 ± 0.10	∅ 1.5 ^{+0.10} ₀	1.20 max.
YFF21				

() Reference value.

Appendix 4

Plastic Tape

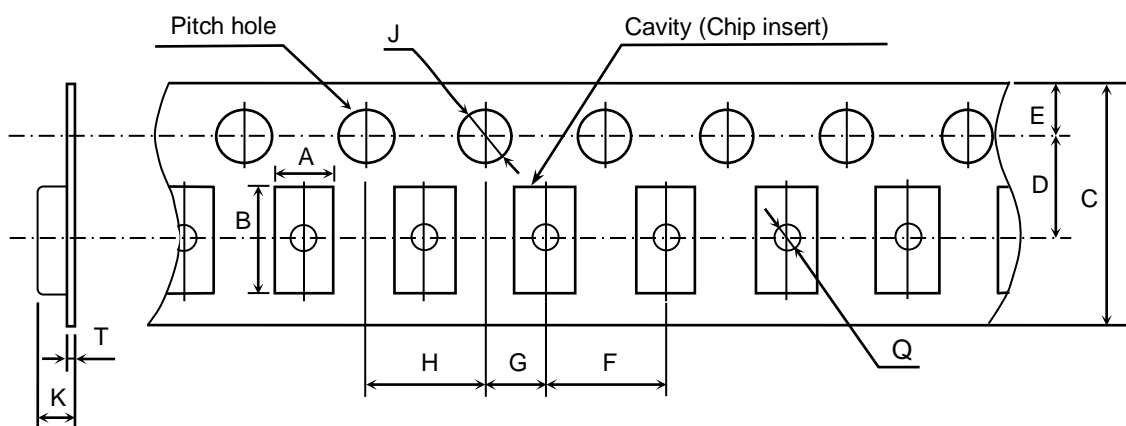

(Unit : mm)

Symbol Type	A	B	C	D	E	F
YFF31	(1.90)	(3.50)	8.00±0.30	3.50±0.05	1.75±0.10	4.00±0.10

Symbol Type	G	H	J	K	T	Q
YFF31	2.00±0.05	4.00±0.10	∅1.5 ^{+0.10} ₀	2.50 max.	0.30 max.	∅0.50 min.

() Reference value.

Appendix 5

Dimensions of reel (Material : Polystyrene)

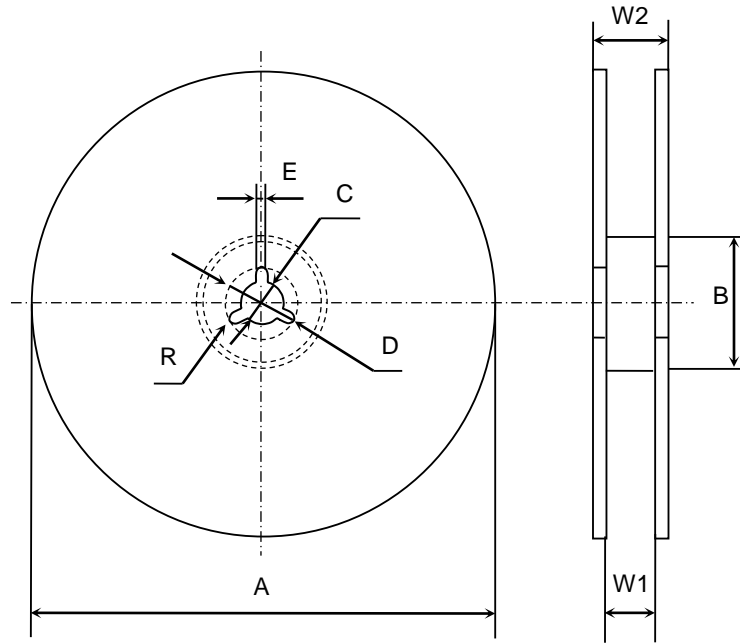

(Unit : mm)

Symbol	A	B	C	D	E	W1
Dimension	$\phi 178 \pm 2.0$	$\phi 60 \pm 2.0$	$\phi 13 \pm 0.5$	$\phi 21 \pm 0.8$	2.0 ± 0.5	9.0 ± 0.3

Symbol	W2	R
Dimension	13.0 ± 1.4	1.0

Appendix 6

Dimensions of reel (Material : Polystyrene)

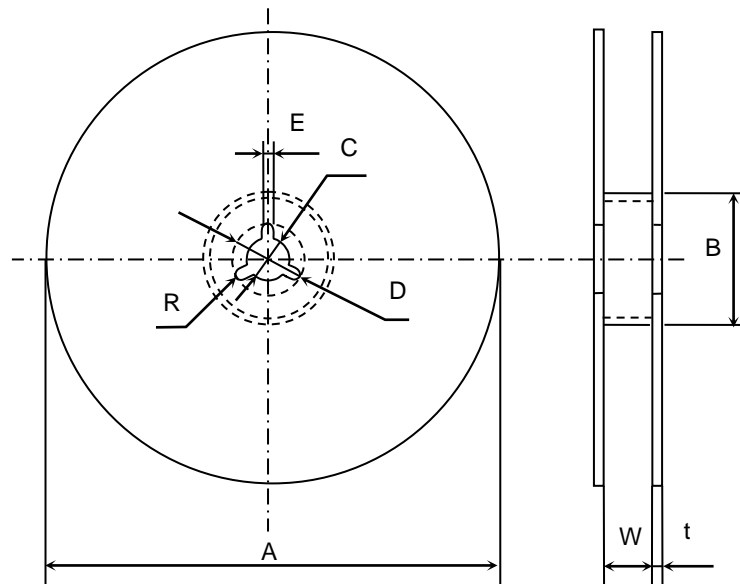

(Unit : mm)

Symbol	A	B	C	D	E	W
Dimension	$\phi 382$ max. (Nominal $\phi 330$)	$\phi 50$ min.	$\phi 13 \pm 0.5$	$\phi 21 \pm 0.8$	2.0 ± 0.5	10.0 ± 1.5

Symbol	t	R
Dimension	2.0 ± 0.5	1.0