

RPA SERIES

Single-Phase Filter with Inlet Socket Type for High-Voltage Pulse Noise



■ FEATURES

- This product provides superior attenuation for both differential mode and common mode noise.
- Amorphous core is used as the common mode coil core for the RPE series, which helps prevent device error.
- Leakage current of standard type is 0.5 mA max and also lineup low-leakage current characteristic type is 0.01 mA max.
- Faston terminal #250 (t=0.8mm).

■ SAFETY STANDARDS

UL1283	UL File No. E62388
CSA C22.2 No.8 (cUL)	UL File No. E62388
EN60939-1/-2 (NEMKO)	Certificate No. P12215895

■ PRODUCT IDENTIFICATION

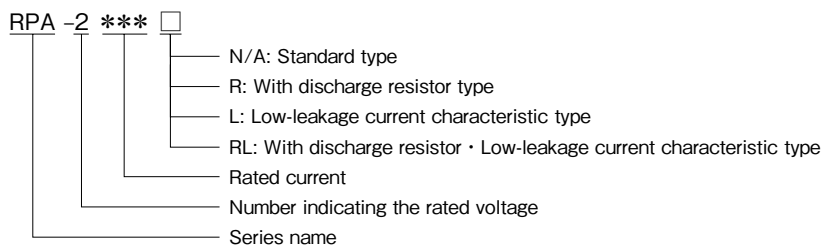

■ CONFORMITY TO RoHS Directive

• Faston® is a registered trademark of TE Connectivity.

■ CIRCUIT DIAGRAMS

RPA-2 ***

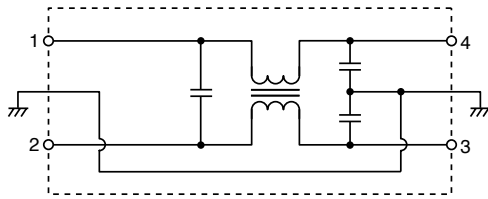

RPA-2 *** L

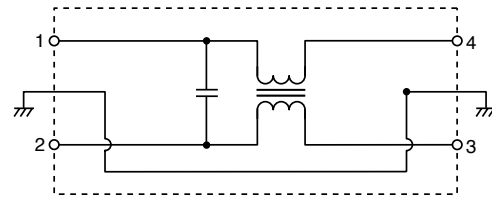

RPA-2 *** R

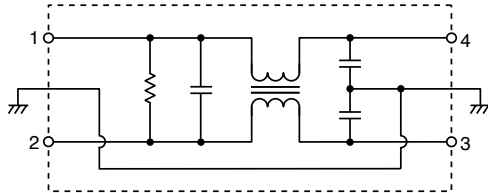

RPA-2 *** RL

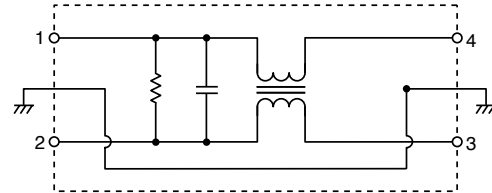

■ PANEL INSTALLATION MEASUREMENT

From back side panel

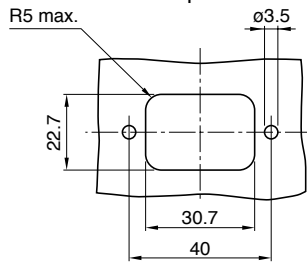

From front panel

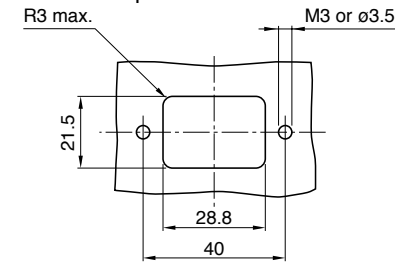

■ ELECTRICAL CHARACTERISTICS

RPA-2 *** / R

Part No.	Rated voltage (AC/DC)	Rated current (AC/DC)	Withstand voltage	Insulation resistance	Leakage current	Operating temperature range	With derating over	DC resistance (mΩ)	Attenuation frequency range (MHz)		Weight (g)	
									Common mode	Differential mode		
									at 25dB	at 25dB		
RPA-2003	250V	3A	AC.1500V	100MΩ min.	0.5mA max.	-25 to +85°C	55°C	150 max.	2 to 30	3 to 30	40	
RPA-2006		6A							60s	3 to 30		5 to 30
RPA-2003R		3A	[line - earth]						[DC.500V/1min]	2 to 30		3 to 30
RPA-2006R		6A								3 to 30		5 to 30

RPA-2 *** L/RL

Part No.	Rated voltage (AC/DC)	Rated current (AC/DC)	Withstand voltage	Insulation resistance	Leakage current	Operating temperature range	With derating over	DC resistance (mΩ)	Attenuation frequency range (MHz)		Weight (g)	
									Common mode	Differential mode		
									at 10dB	at 15dB		
RPA-2003L	250V	3A	AC.1500V	100MΩ min.	0.01mA max.	-25 to +85°C	55°C	150 max.	0.4 to 10	1 to 30	40	
RPA-2006L		6A							60s	0.5 to 8		2 to 30
RPA-2003RL		3A	[line - earth]						[DC.500V/1min]	0.4 to 10		1 to 30
RPA-2006RL		6A								0.5 to 8		2 to 30

DERATING GRAPH

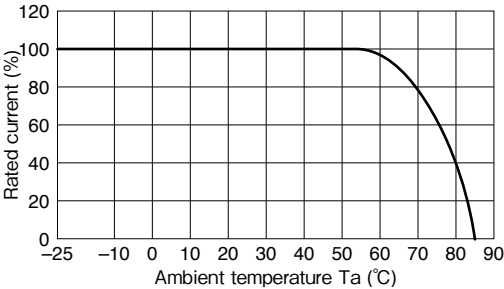

SHAPES AND DIMENSIONS

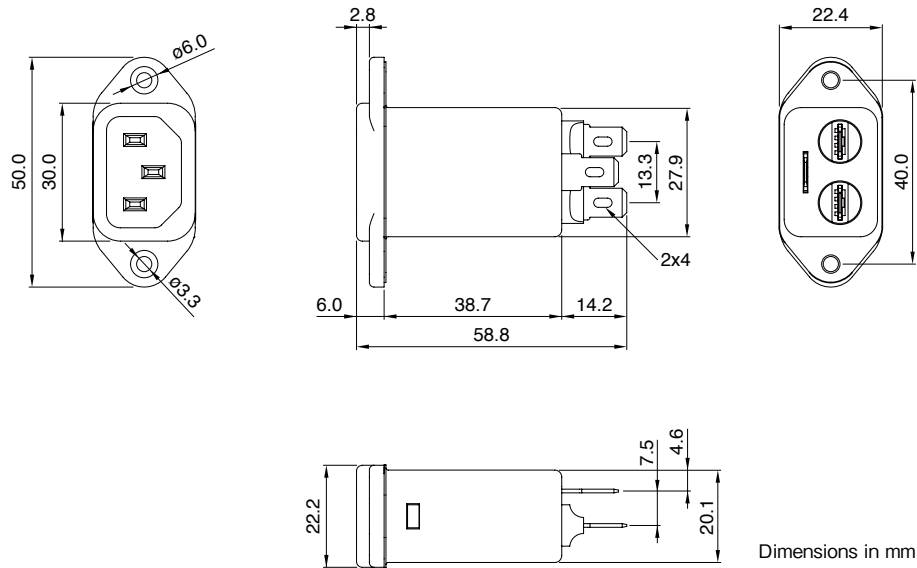

All specifications are subject to change without notice.

ATTENUATION vs. FREQUENCY CHARACTERISTICS

RPA-2003/RPA-2003R

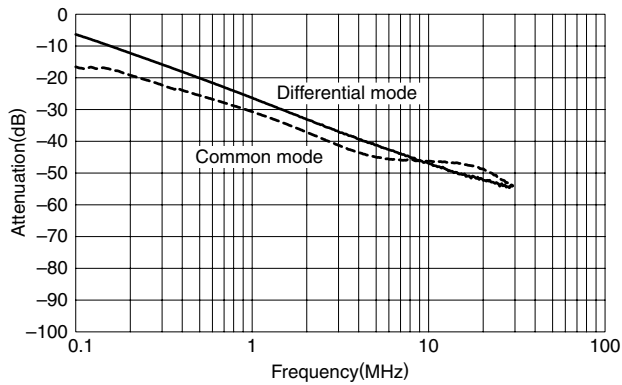

RPA-2006/RPA-2006R

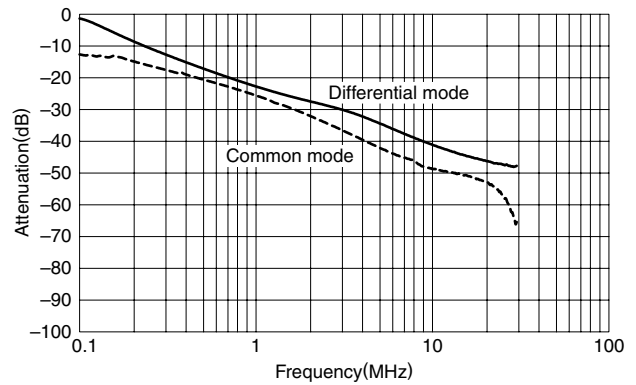

RPA-2003L/RPA-2006RL

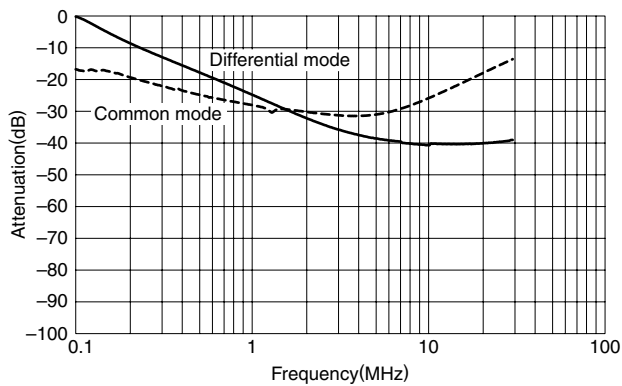

RPA-2006L/RPA-2006RL

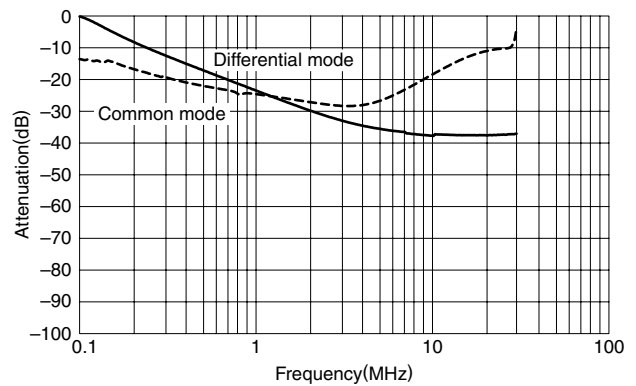

PULSE ATTENUATION CHARACTERISTICS

RPA-2003/RPA-2003R

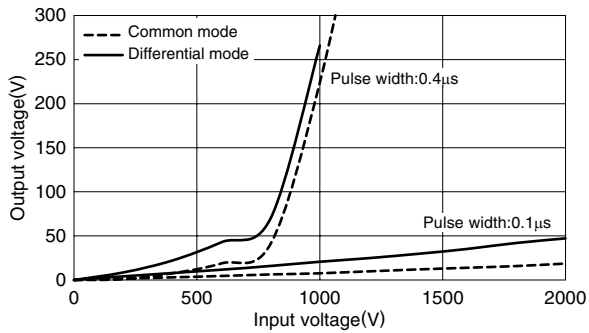

RPA-2006/RPA-2006R

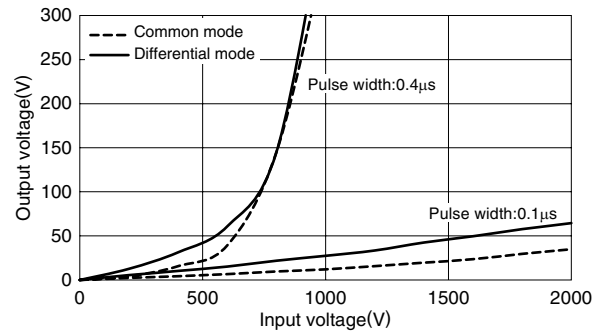

RPA-2003L/RPA-2006RL

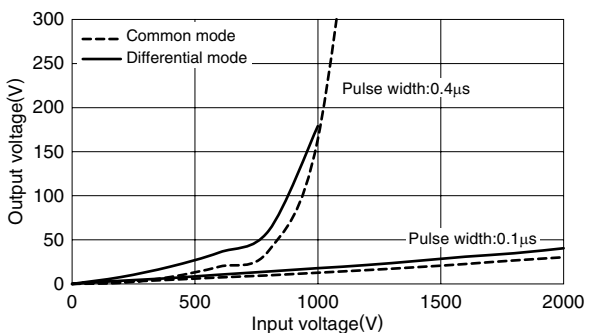

RPA-2006L/RPA-2006RL

