

Inductors for power circuits

Wound ferrite

HPL series (for automotive)



AEC-Q200

## HPL505028F type



## FEATURES

- Achieved high-reliability inductors without joints
- Adoption of ferrites made of LowLoss material and low-RDC by frame forming
- Realizing low EMI (Electromagnetic Interference) through magnetic flux cancellation structure (3-terminal structure).
- Operating temperature range: -55 to +155°C (including self-temperature rise)
- Compliant with AEC-Q200

## APPLICATION

- ADAS - Level5 for Camera

## PART NUMBER CONSTRUCTION

HPL	505028	F	R10	M	RD3P
Series name	LxWxH dimensions 5.0x5.0x2.8 mm	Internal code	Inductance (nH)	Inductance tolerance	Internal code

## CHARACTERISTICS SPECIFICATION TABLE

L	Measuring frequency (kHz)	DC resistance		Rated current*				Part No.	
		(mΩ)max.	(mΩ)typ.	Isat 1 (A)25deg.C		Isat 2 (A)25deg.C			Itemp (A)typ.
(nH) Tolerance				(A)25deg.C	(A)125deg.C	(A)25deg.C	(A)125deg.C	(A)typ.	
60 ±20%	100	0.88	0.8	43.5	32.5	45.5	34.0	34.0	<a href="#">HPL505028F060MRD3P</a>
70 ±20%	100	0.88	0.8	39.0	29.0	41.0	30.5	34.0	<a href="#">HPL505028F070MRD3P</a>
80 ±20%	100	0.88	0.8	35.0	26.0	36.5	27.0	34.0	<a href="#">HPL505028F080MRD3P</a>
100 ±20%	100	0.88	0.8	27.5	20.5	28.5	21.5	34.0	<a href="#">HPL505028FR10MRD3P</a>
120 ±20%	100	0.88	0.8	22.0	16.5	24.0	18.0	34.0	<a href="#">HPL505028FR12MRD3P</a>
150 ±20%	100	0.88	0.8	17.0	12.5	19.0	14.0	34.0	<a href="#">HPL505028FR15MRD3P</a>

\* Rated current: smaller value of either Isat or Itemp.

Isat 1: When based on the inductance change rate (20% below the initial value)

Isat 2: When based on the inductance change rate (30% below the initial value)

Itemp: When based on the temperature increase (temperature increase of 40°C by self heating)

## Measurement equipment

Measurement item	Product No.	Manufacturer
L	4294A	Keysight Technologies
DC resistance	3541	HIOKI
Rated current Isat	3260B	Wayne Kerr Electronics

\* Equivalent measurement equipment may be used.

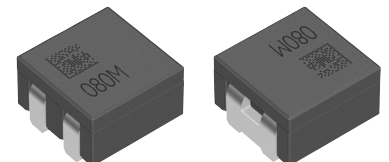

# HPL505028F type

## L FREQUENCY CHARACTERISTICS

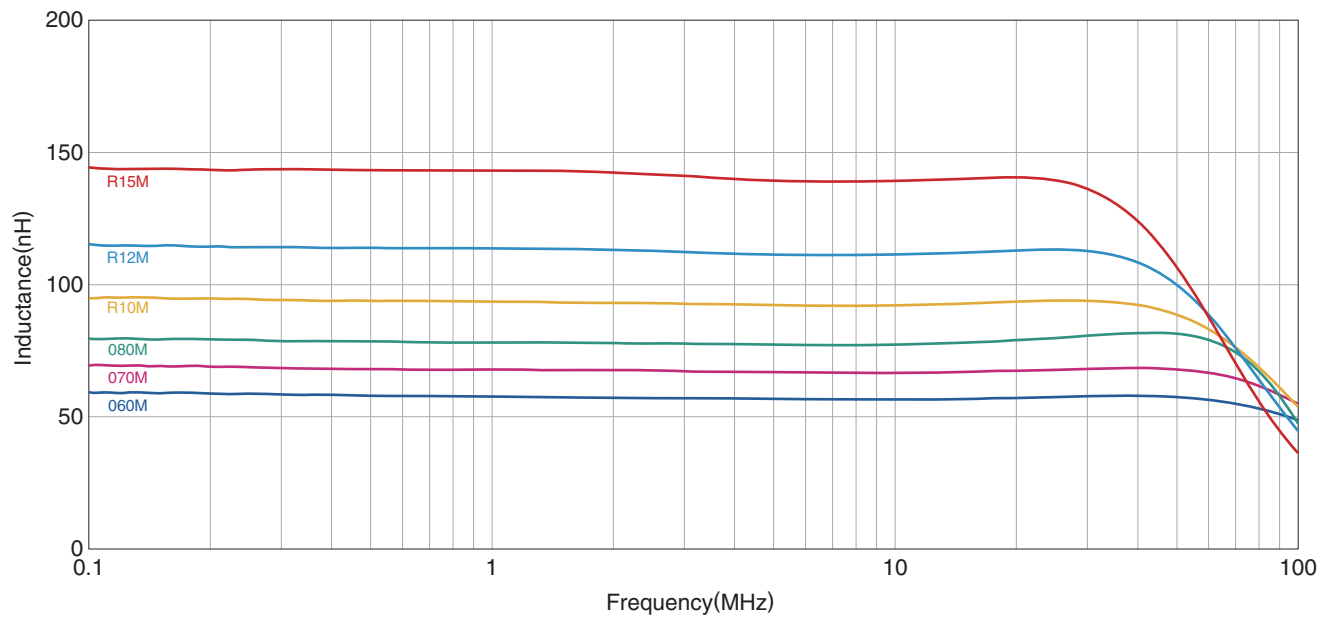

### Measurement equipment

Product No.	Manufacturer
4294A	Keysight Technologies

\* Equivalent measurement equipment may be used.

## L VS. DC BIAS CHARACTERISTICS

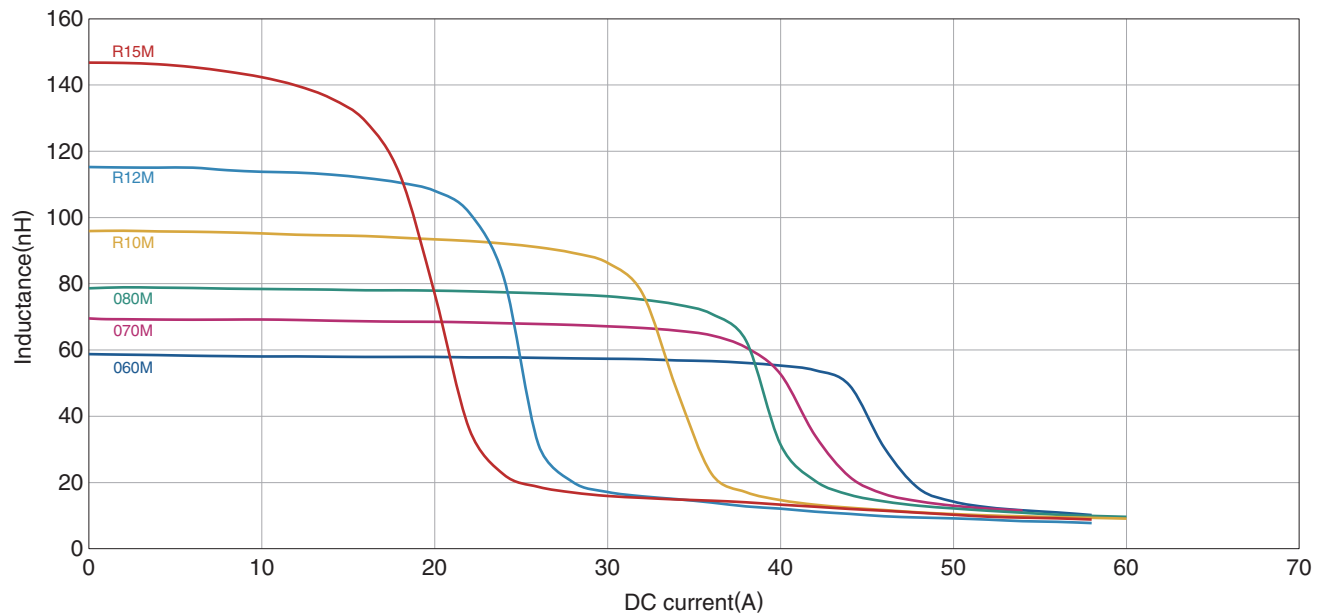

### Measurement equipment

Product No.	Manufacturer
3260B	Wayne Kerr Electronics

\* Equivalent measurement equipment may be used.

# HPL505028F type

## SHAPE & DIMENSIONS

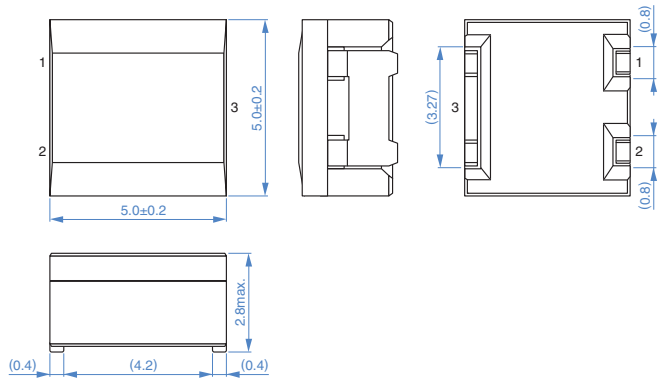

Dimensions in mm

\* This product has 3 terminals. Pin 3 terminal is an dummy terminal, so open wiring is required.

## RECOMMENDED LAND PATTERN

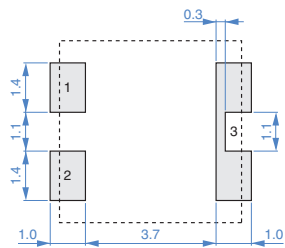

Dimensions in mm

## CIRCUIT DIAGRAM

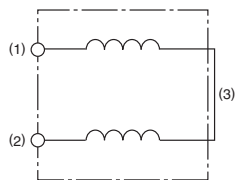

## RECOMMENDED REFLOW PROFILE

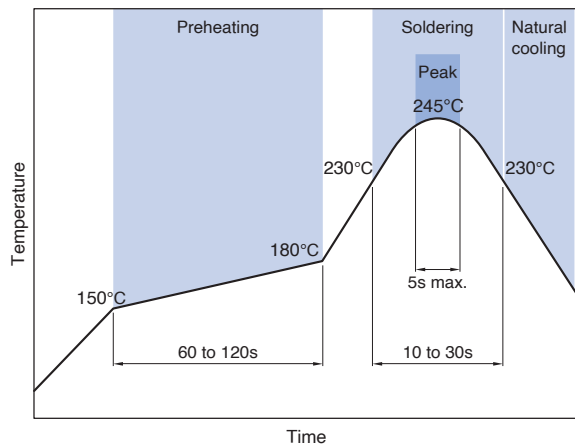

## PACKAGING STYLE

### REEL DIMENSIONS

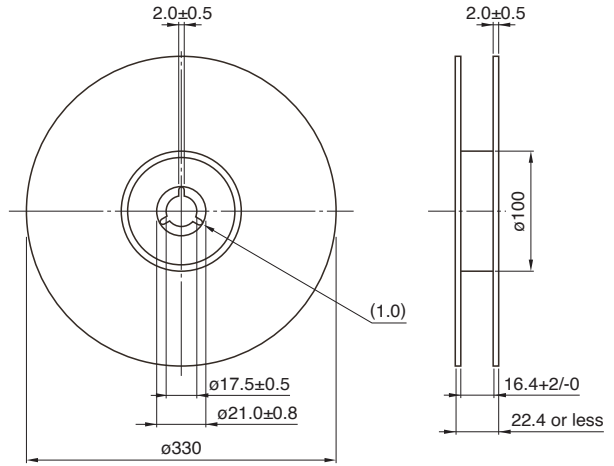

Dimensions in mm

### TAPE DIMENSIONS

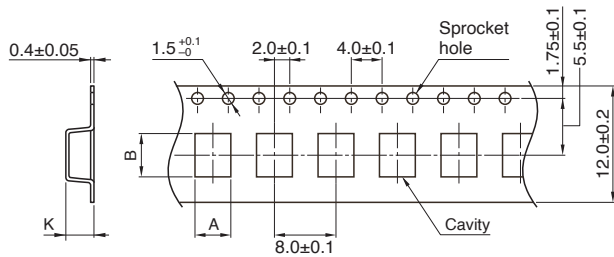

Dimensions in mm

Type	A	B	K
HPL505028F	(5.3)	(5.3)	(2.9)

### PACKAGE QUANTITY

Package quantity	1000 pcs/reel
------------------	---------------

### TEMPERATURE RANGE, INDIVIDUAL WEIGHT

Operating temperature range *	Storage temperature range **	Individual weight
-55 to +155 °C	-55 to +155 °C	0.28 g

\* Operating temperature range includes self-temperature rise.

\*\* The storage temperature range is for after the assembly.

## REMINDERS FOR USING THESE PRODUCTS

Before using these products, be sure to request the delivery specifications.

### SAFETY REMINDERS

Please pay sufficient attention to the warnings for safe designing when using this products

### REMINDERS

- The storage period is within 12 months. Be sure to follow the storage conditions (temperature: 5 to 40°C, humidity: 10 to 75% RH or less).  
If the storage period elapses, the soldering of the terminal electrodes may deteriorate.
- Soldering corrections after mounting should be within the range of the conditions determined in the specifications.  
If overheated, a short circuit, performance deterioration, or lifespan shortening may occur.
- Do not use products that have received any excessive mechanical shock such as by being dropped.
- When embedding a printed circuit board where a chip is mounted to a set, be sure that residual stress is not given to the chip due to the overall distortion of the printed circuit board and partial distortion such as at screw tightening portions.
- Self heating (temperature increase) occurs when the power is turned ON, so the tolerance should be sufficient for the set thermal design.
- Do not expose the products to magnets or magnetic fields.
- The performance of the product may deteriorate if coating materials are used, thus please assess the situation beforehand by taking this factor into consideration.
- Do not use for a purpose outside of the contents regulated in the delivery specifications.
- The products described in this catalog are intended to be installed in automobiles or automotive electronic equipment (AV equipment, telecommunications equipment, home appliances, amusement equipment, computer equipment, personal equipment, office equipment, measurement equipment, industrial robots) and to be used in automobiles (including the case where the said automotive product is mounted in a vehicle) or standard applications as general electronic equipment in automotive applications or standard applications as general electronic equipment in automotive applications in accordance with the scope and conditions described in this specification, while the said automotive or general electronic equipment including the said product is intended to be used in the usual operation and usage methods, respectively. Other than automotive or automotive products are not designed or warranted to meet the requirements of the applications listed below, whose performance and/or quality requires a more stringent level of safety or reliability, or whose failure, malfunction or defect could cause serious damage to society, person or property.  
Please understand that we are not responsible for any damage or liability caused by use of the products in any of the applications below or for any other use exceeding the range or conditions set forth in this specification sheet.  
If you intend to use the products in the applications listed below or if you have special requirements exceeding the range or conditions set forth in this specification, please contact us.

- (1) Aerospace/aviation equipment
- (2) Transportation equipment (electric trains, ships, etc.)
- (3) Medical equipment
- (4) Power-generation control equipment
- (5) Atomic energy-related equipment
- (6) Seabed equipment

- (7) Transportation control equipment
- (8) Public information-processing equipment
- (9) Military equipment
- (10) Electric heating apparatus, burning equipment
- (11) Disaster prevention/crime prevention equipment
- (12) Safety equipment
- (13) Other applications that are not considered general-purpose applications

When designing your equipment even for general-purpose applications, you are kindly requested to take into consideration securing protection circuit/device or providing backup circuits in your equipment.