



Chip varistors

Voltage Protection Devices

Automotive grade

AVR series

AVRM, AVR-M series

AVRM1608/AVR-M1608 JIS 1608 [EIA 0603]

AVRM2012/AVR-M2012 JIS 2012 [EIA 0805]

AVRL series

AVRL10 JIS 1005 [EIA 0402]

AVRL16 JIS 1608 [EIA 0603]

AVRH series

AVRH10 JIS 1005 [EIA 0402]

AVRH16A2 JIS 1608 [EIA 0603]

REMINDERS FOR USING THESE PRODUCTS

Before using these products, be sure to request the delivery specifications.

SAFETY REMINDERS

Please pay sufficient attention to the warnings for safe designing when using this products.

REMINDERS

- Please pay careful attention to the precautions and follow safe designing practices when using these products.
- Please observe the following precautions in order to avoid problems with chip varistors such as characteristic degradation and element destruction
 - Please store these products in an environment with a temperature of 5 to 40°C and humidity level of 20 to 70%RH, and use them within six months.
 - Poor storage conditions may lead to the deterioration of the solderability of the edge electrodes, so please be careful to avoid contact with humidity, dew condensation, dust, toxic gas (hydrogen, hydrogen sulfide, sulfurous acid, chlorine, ammonia, etc.), direct sunlight, and so on.
 - Please do not use products that have been dropped or detached when mounting.
 - Please solder with the reflow soldering method, and not the flow (dip) soldering method.
- Please observe the following precautions to avoid problems with varistors such as characteristic degradation and element destruction, which ultimately lead to the generation of heat and smoke with the elements.
 - Do not use in locations where the temperatures exceed the operating temperature range such as under direct sunlight or near sources of heat.
 - Do not use in locations where there are high levels of humidity such as under direct exposure to weather and areas where steam is released.
 - Do not use in locations such as dusty areas, high-saline environments, places where the atmosphere is contaminated with corrosive gas, etc.
 - Avoid powerful vibrations, impact (such as by dropping), pressure, etc. that may lead to splitting in the products.
 - Do not use with a voltage that exceeds the maximum allowable circuit voltage.**
 - When resin coating (including modular) a varistor, do not use a resin that will cause deterioration of the varistor. Be sure never to use resin that generates hydrogen as palladium is used for the inner electrode.
 - Avoid attachment near combustible materials.
- Please contact our sales offices when considering the use of the products listed on this catalog for applications, whose performance and/or quality require a more stringent level of safety or reliability, or whose failure, malfunction or trouble could cause serious damage to society, person or property (\specific uses\ such as automobiles, airplanes, medical instruments, nuclear devices, etc.) as well as when considering the use for applications that exceed the range and conditions of this catalog.
- As range of catalog, conditions are transcended, or for damage that generated by was used in application specific, etc, accept no the responsibility, wish.
- Please take appropriate measures such as acquiring protective circuits and devices that meet the uses, applications, and conditions of the instruments and keeping backup circuits.

Chip varistors

Automotive grade

RoHS Directive Compliant Product
Compatible with lead-free solders
AEC-Q200

Overview of the AVR series

■ characteristics of chip varistor

Varistors are voltage dependent nonlinear resistive elements with a resistance that decreases rapidly when the voltage is over the constant value.
Varistors become zener diode of 2 serial connection and equivalent, and does not have polarity.

□ current vs. voltage characteristics

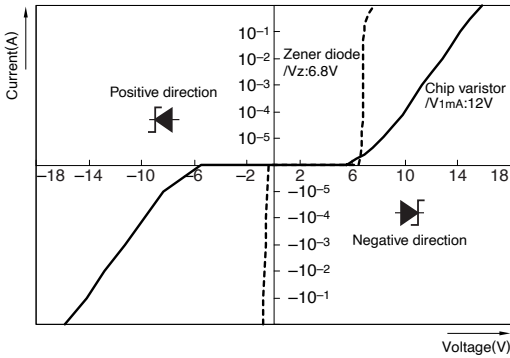

□ the effect of the varistor

Without varistor

A malfunction and failure of electronic equipment

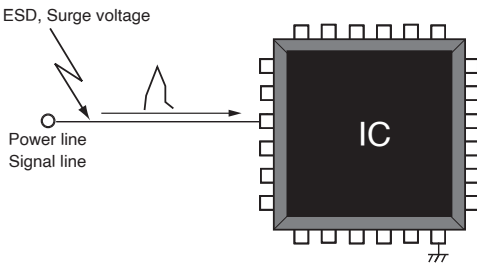

With Varistor

Suppress transient voltage by inserting varistor in a circuit

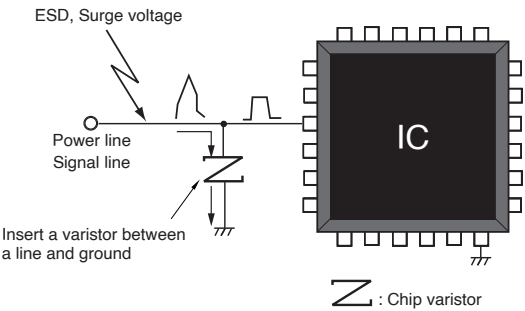

■ Equivalent circuit of chip varistors

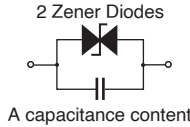

■ CHIP VARISTORS FEATURE

- IEC61000-4-2 compliant
- Reliability characteristics evaluated based on AEC-Q200 condition.
- High ESD withstanding voltage
- Small-sized products are available
- 125°C, 150°C Supported

Figure 1 internal structure of multilayer chip varistors

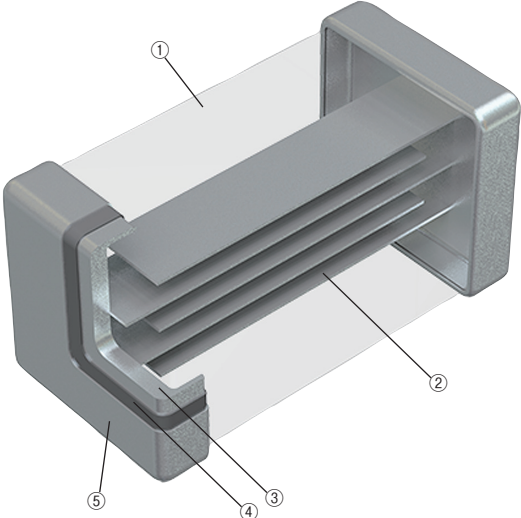

No.	Name
(1)	Semiconductor ceramic
(2)	Internal electrode (Pd)
(3)	Terminal electrode Ag
(4)	Terminal electrode Ni
(5)	Terminal electrode Sn

Please be sure to request delivery specifications that provide further details on the features and specifications of the products for proper and safe use. Please note that the contents may change without any prior notice due to reasons such as upgrading.

Chip varistors

Automotive grade

RoHS Directive Compliant Product
Compatible with lead-free solders
AEC-Q200

Overview of the AVR series

Communication standard, circuit example and communication standard

		LIN/CXPI	Classical CAN	CAN/CAN-FD
Type	DimensionscodeJIS[EIA]			
		20 kbps	1 Mbps	2-8 Mbps
Chip varistors	1005 [0402]	AVRH10C220YT201MA8	AVRH10C270KT350NA8	AVRH10C270KT150NA8
	1608 [0603]	AVRM1608C270KT221M	AVR-M1608C270MTAAB	AVR-M1608C270MTABB
	1608 [0603] 2 in 1 Array	N/A	AVRH16A2C270KT200NA8	AVRH16A2C270KT200NA8
	2012 [0805]	N/A	N/A	N/A

		FlexRay	MOST50	USB2.0
Type	DimensionscodeJIS[EIA]			
		10 Mbps	50 Mbps	480 Mbps
Chip varistors	1005 [0402]	AVRH10C270KT150NA8	AVRH10C270KT150NA8	AVRL101D3R3FTA
	1608 [0603]	AVR-M1608C270MTABB	AVR-M1608C270MTABB	AVRL161D3R3FTA
	2012 [0805]	N/A	N/A	N/A

		One-Pair Ethernet 100BASE-T1	One-Pair Ethernet 1000BASE-T1	Motors
Type	DimensionscodeJIS[EIA]			
		100Mbps	1000Mbps	-
Chip varistors	1005 [0402]	AVRH10C101KT4R7FA8	AVRH10C101KT1R2YE8 AVRH10C221KT1R5YA8	N/A
	1608 [0603]	N/A	N/A	AVR-M1608C270KT6AB
	2012 [0805]	N/A	N/A	AVR-M2012C390KT6AB

⚠ Please be sure to request delivery specifications that provide further details on the features and specifications of the products for proper and safe use.
Please note that the contents may change without any prior notice due to reasons such as upgrading.

Chip varistors

Automotive grade

RoHS Directive Compliant Product
Compatible with lead-free solders
AEC-Q200

Overview of the AVR series

Part number construction

AVRM series

AVRM	1608	C	390	K	T	271	N
Series name	L x W dimensions (mm)	Structure code	Varistor voltage (V)	Varistor voltage tolerance (%)	Packaging style	Capacitance or internal special symbol (pF)	Capacitance tolerance (%)
AVRM series	1608 1.6x0.8 2012 2.0x1.2	C General structure	390=39x10 ⁰ 220 22 270 27 390 39	K ±10 M ±20 N ±30	T Taping	271=27x10 ¹ 221 220 271 270	K ±10 M ±20 N ±30

AVR-M series

AVR-M	1608	C	270	M	T	AAB
Series name	L x W dimensions (mm)	Structure code	Varistor voltage (V)	Varistor voltage tolerance (%)	Packaging style	Company special symbol
AVR-M series	1608 1.6x0.8 2012 2.0x1.2	C General structure	270=27x10 ⁰ 220 22 270 27 390 39	K ±10 M ±20 N ±30	T Taping	

AVRL series

AVRL	10	1D	3R3	F	T	A
Series name	L x W dimensions (mm)	Maximum continuous voltage (Vdc)	Capacitance (pF)	Capacitance tolerance (pF)	Packaging style	Company special symbol
AVRL series	10 1.0x0.5 L=Low cap 16 1.6x0.8	1D 20	3R3 3.3 6R8 6.8	F ±1 G ±2	T Taping	

Chip varistors

Automotive grade

RoHS Directive Compliant Product
Compatible with lead-free solders
AEC-Q200

Overview of the AVR series

Part number construction

AVRH series

AVRH	10	C	270	K	T				
Series name	L x W dimensions (mm)	Structure code		Varistor voltage (V)		Varistor voltage tolerance (%)		Packaging style	
AVRH series	10 1.0x0.5	C	General structure	270=27x10 ⁰		K	±10	T	Taping
H=High Reliability				270	27	Y	Special		
				390	39				
				101	100				

150	N	A	8			
Capacitance (pF)	Capacitance tolerance		ESD voltage tolerance IEC61000-4-2 (kV)		Operating temperature limit (°C)	
150=15x10 ⁰	N	±30%	A	25	8	150
150	15	F	±1pF	E	8	
500	50	M	±20%			
4R7	4.7	Y	Special			

AVRH series(array)

AVRH	16	A2	C	270	K	T			
Series name	L x W dimensions (mm)	Type	Structure code	Varistor voltage (V)		Varistor voltage tolerance (%)		Packaging style	
AVRH series	16 1.6x0.8	A2 2in1 Array	C General structure	270=27x10 ⁰		K	±10	T	Taping
H=High Reliability				270	27				

200	N	A	8			
Capacitance (pF)	Capacitance tolerance		ESD voltage tolerance IEC61000-4-2 (kV)		Operating temperature limit (°C)	
200=20x10 ⁰	N	±30%	A	25	8	150
200	20					

Chip varistors

Automotive grade

RoHS Directive Compliant Product
Compatible with lead-free solders
AEC-Q200

Overview of the AVR series

terminology

Item	Unit	Description
Varistor voltage(Breakdown voltage)	V1mA(V)	Chip varistor-terminal voltage when DC1mA was flowed
Maximum continuous voltage	Vdc(V)	DC voltage that is continuously applied between chip varistor terminals Terminal chip varistors leakage current-value: 50 μ A max Voltage appearing across the varistor when a pulse current (8/20 μ s*1) of specified peak value is applied.
Clamping voltage	Vcl(V)	Voltage between terminal chip varistors of the Specified peak current value of the impulse current(8/20 μ s*1) is applied
Maximum energy	E(Joule)	When applied specified peak impulse current-value current(10/1000 μ s*2) once, maximum energy that electrical property of chip varistors be not deteriorated
Maximum peak current	I _p (A)	When applied impulse current(8/20 μ s*1) once, maximum current that electrical property of chip varistors be not deteriorated
Capacitance	C(pF)	Oscillator frequency 1kHz or 1MHz, Capacitance between chip varistor-terminal in oscillator voltage 1Vrms
Capacitance Difference	Δ C(pF)	Measure the capacitance of each Ch at an oscillator frequency of 1 MHz and an oscillator voltage of 1 V, The absolute value of the difference of the capacitance values obtained

*1 8/20 μ s test waveform

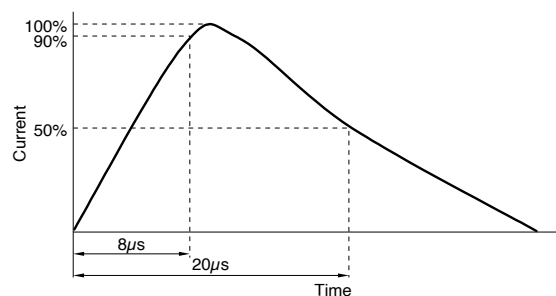

*2 10/1000 μ s test waveform

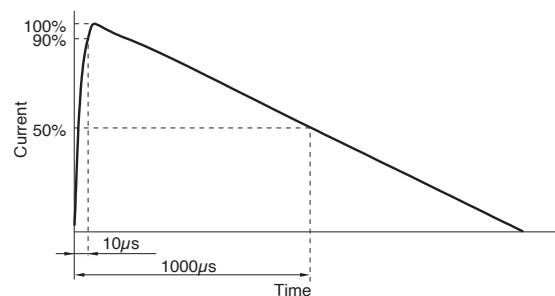

Chip varistors

Automotive grade

RoHS Directive Compliant Product
Compatible with lead-free solders
AEC-Q200

AVR series 1005 type

SHAPE & DIMENSIONS

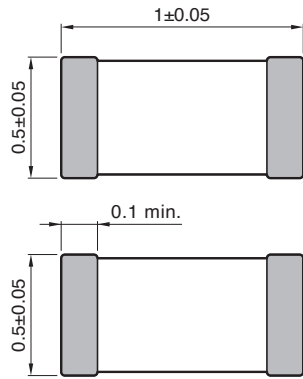

Electrode material
Internal: Pd
External: Ag/Ni/Sn

Dimensions in mm

RECOMMENDED LAND PATTERN

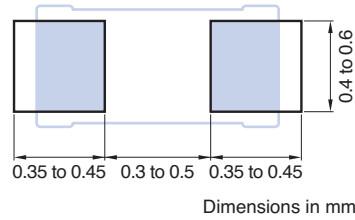

Dimensions in mm



Product characteristics list

Item	V1mA	C	Vdc	Vcl	E	I _p	Operating temperature range	ESD voltage tolerance
	(V)	1kHz/1MHz* (pF)	DC (V)	8/20μs (V)	10/1000μs (J)	8/20μs (A)	(°C)	IEC61000-4-2 (kV)
AVRL101D3R3FTA	27(21.6 to 32.4)	3.3(2.3 to 4.3)*	20	62(0.5A)	0.01	0.5	-40 to 125	8
AVRL101D6R8GTA	27(21.6 to 32.4)	6.8(4.8 to 8.8)*	20	58(1A)	0.01	1	-40 to 125	8

V1mA: Varistor voltage, C: Capacitance, Vdc: Maximum allowable circuit voltage, Vcl: Clamping voltage, E: Energy capacity, I_p: Surge current

Chip varistors

Automotive grade

RoHS Directive Compliant Product
Compatible with lead-free solders
AEC-Q200

AVRH series 1005 type

SHAPE & DIMENSIONS

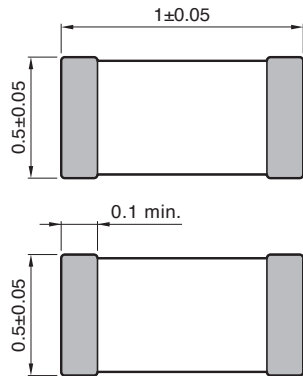

Electrode material
Internal: Pd
External: Ag/Ni/Sn

Dimensions in mm

RECOMMENDED LAND PATTERN

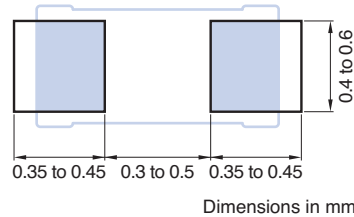

Product characteristics list

Item	V1mA (V)	C 1kHz/1MHz* (pF)	Vdc Vcl		E 10/1000µs (J)	Ip 8/20µs (A)	Operating temperature range (°C)	ESD voltage tolerance IEC61000-4-2 (kV)
			DC (V)	8/20µs (V)				
AVRH10C220YT201MA8	22(19 to 26)	200(160 to 240)	16	40(2A)	0.07	40	-55 to 150	25
AVRH10C270KT150NA8	27(24 to 30)	15(10.5 to 19.5)	19	52(2A)	0.02	2	-55 to 150	25
AVRH10C270KT350NA8	27(24 to 30)	35(24.5 to 45.5)	19	52(2A)	0.02	8	-55 to 150	25
AVRH10C390KT500NA8	39(35 to 43)	50(35 to 65)	28	72(2A)	0.06	15	-55 to 150	25
AVRH10C101KT4R7FA8	100(90 to 110)	4.7(3.7 to 5.7)*	70	190(1A)	0.03	1	-55 to 150	25
AVRH10C101KT4R7YA8	115(103.5 to 126.5)	4.7(4.13 to 5.27)*	70	212(1A)	0.03	1	-55 to 150	25
AVRH10C101KT1R1NE8	110(100 to 120)	1.1(0.8 to 1.4)*	70	187(0.3A)	0.007	0.3	-55 to 150	8
AVRH10C101KT1R2YE8	110(100 to 120)	1.23(1.10 to 1.36)*	70	187(0.3A)	0.007	0.3	-55 to 150	8
AVRH10C221KT1R5YA8	220(198 to 242)	1.5(1.37 to 1.63)*	70	400(0.5A)	0.007	0.5	-55 to 150	25

V1mA: Varistor voltage, C: Capacitance, Vdc: Maximum allowable circuit voltage, Vcl: Clamping voltage, E: Energy capacity, Ip: Surge current

Chip varistors
Automotive grade

RoHS Directive Compliant Product
Compatible with lead-free solders
AEC-Q200

AVR series 1608 type

SHAPE & DIMENSIONS

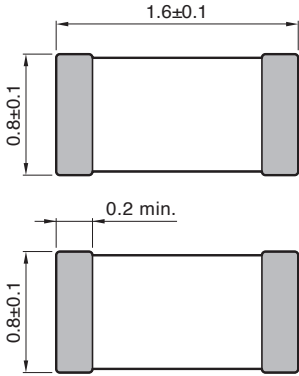

Electrode material
Internal: Pd
External: Ag/Ni/Sn
Dimensions in mm

RECOMMENDED LAND PATTERN

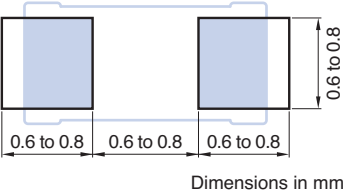

Product characteristics list

Item	V1mA (V)	C 1kHz/1MHz* (pF)	Vdc Vcl		E 10/1000µs (J)	Ip 8/20µs (A)	Operating temperature range (°C)	ESD voltage tolerance IEC61000-4-2 (kV)
			DC (V)	8/20µs (V)				
AVR-M1608C220KT2AB	22(19.8 to 24.2)	210(168 to 252)	16	37(2A)	0.03	10	-40 to 125	25
AVR-M1608C220KT6AB	22(19.8 to 24.2)	560(448 to 672)	16	34(2A)	0.1	30	-40 to 125	25
AVR-M1608C270MTABB	27(21.6 to 32.4)	15(11 to 20)	17	52(2A)	0.05	2	-55 to 150	25
AVR-M1608C270MTAAB	27(21.6 to 32.4)	30(21 to 39)	17	52(2A)	0.05	2	-55 to 150	25
AVR-M1608C270KTACB	27(24 to 30)	60(42 to 78)	19	54(2A)	0.05	10	-55 to 150	25
AVRM1608C270KT800M	27(24 to 30)	80(64 to 96)	19	53(2A)	0.02	28	-55 to 150	25
AVR-M1608C270KT2AB	27(24 to 30)	160(128 to 192)	19	42(2A)	0.1	20	-55 to 150	25
AVRM1608C270KT221M	27(24 to 30)	220(176 to 264)	19	52(2A)	0.1	56	-55 to 150	25
AVR-M1608C270KT6AB	27(24 to 30)	430(344 to 516)	19	42(2A)	0.1	48	-55 to 150	25
AVR-M1608G270KT6AB	27(24 to 30)	430(344 to 516)	19	42(2A)	0.1	48	-55 to 150	25
AVRM1608C390KT271N	39(35 to 43)	270(216 to 324)	28	69(2A)	0.1	78	-55 to 150	25
AVRM1608C560KT101M	56(50.4 to 61.6)	100(80 to 120)	40	113(2A)	0.3	60	-55 to 150	25
AVRM1608C720KT750M	72(64.8 to 79.2)	75(60 to 90)	53	135(2A)	0.1	40	-55 to 150	25
AVRL161D3R3FTA	27(21.6 to 32.4)	3.3(2.3 to 4.3)*	20	62(0.5A)	0.01	0.5	-40 to 125	8
AVRL161D6R8GTA	27(21.6 to 32.4)	6.8(4.8 to 8.8)*	20	58(1A)	0.01	1	-40 to 125	8

V1mA: Varistor voltage, C:Capacitance, Vdc:Maximum allowable circuit voltage, Vcl:Clamping voltage, E:Energy capacity, Ip:Surge current

Please be sure to request delivery specifications that provide further details on the features and specifications of the products for proper and safe use. Please note that the contents may change without any prior notice due to reasons such as upgrading.

Chip varistors

Automotive grade

RoHS Directive Compliant Product
Compatible with lead-free solders
AEC-Q200

AVRH series 1608(array) type

SHAPE & DIMENSIONS

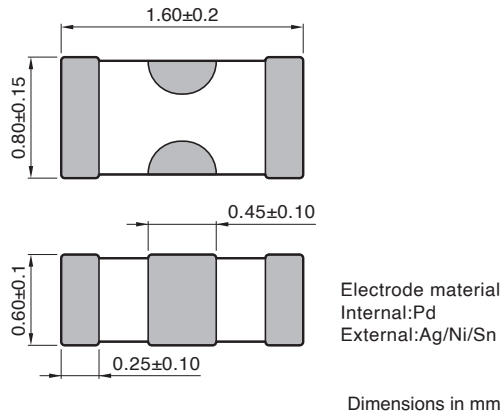

RECOMMENDED LAND PATTERN

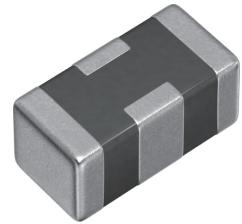
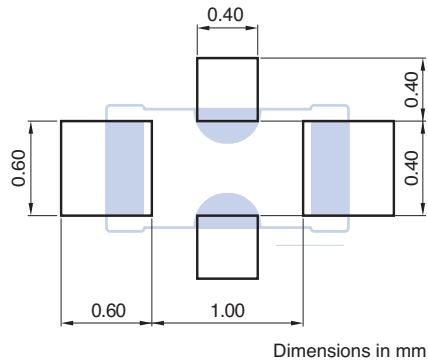

Product characteristics list

Item	V1mA	C	Vdc	Vcl	E	Ip	ΔC	Operating temperature range	ESD voltage tolerance
	(V)	(pF)	(V)	(V)	(J)	(A)	(pF)		(kV)
AVRH16A2C270KT200NA8	27(24 to 30)	20(14 to 26)	19	60(2A)	0.04	4	1.0	-55 to 150	25

V1mA: Varistor voltage, C: Capacitance, Vdc: Maximum allowable circuit voltage, Vcl: Clamping voltage, E: Energy capacity, Ip: Surge current, ΔC: Capacitance difference

Chip varistors

Automotive grade

RoHS Directive Compliant Product
Compatible with lead-free solders
AEC-Q200

AVR series 2012 type

SHAPE & DIMENSIONS

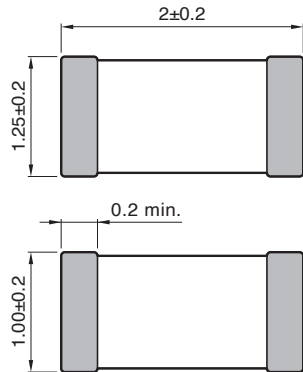

Electrode material
Internal: Pd
External: Ag/Ni/Sn

Dimensions in mm

RECOMMENDED LAND PATTERN

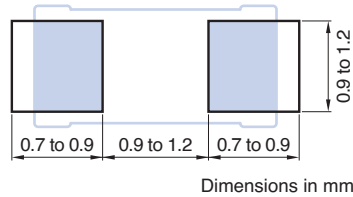

Product characteristics list

Item	V1mA (V)	C 1kHz/1MHz* (pF)	Vdc (V)	Vcl 8/20µs (V)	E 10/1000µs (J)	Ip 8/20µs (A)	Operating temperature range (°C)	ESD voltage tolerance IEC61000-4-2 (kV)
AVR-M2012C220KT6AB	22(19.8 to 24.2)	800(560 to 1040)	16	38(5A)	0.3	100	-40 to 125	25
AVRM2012C330KT801N	33(30 to 36)	800(560 to 1040)	24	59(5A)	0.5	240	-55 to 150	25
AVR-M2012C390KT6AB	39(35 to 43)	430(301 to 559)	28	62(5A)	0.3	100	-55 to 150	25
AVRM2012C560KT251M	56(50.4 to 61.6)	250(200 to 300)	40	113(5A)	0.3	150	-55 to 150	25
AVRM2012C720KT201M	72(64.8 to 79.2)	200(160 to 240)	53	142(5A)	0.3	100	-55 to 150	25

V1mA: Varistor voltage, C: Capacitance, Vdc: Maximum allowable circuit voltage, Vcl: Clamping voltage, E: Energy capacity, Ip: Surge current

Chip varistors

Automotive grade

RoHS Directive Compliant Product
Compatible with lead-free solders
AEC-Q200

AVR series Electrostatic absorption characteristics

■ discharge voltage waveform (example)

□ Without varistor, waveform at varistor installation

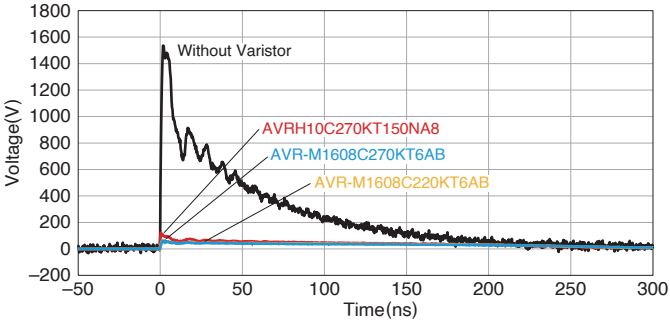

□ Waveform at varistor installation

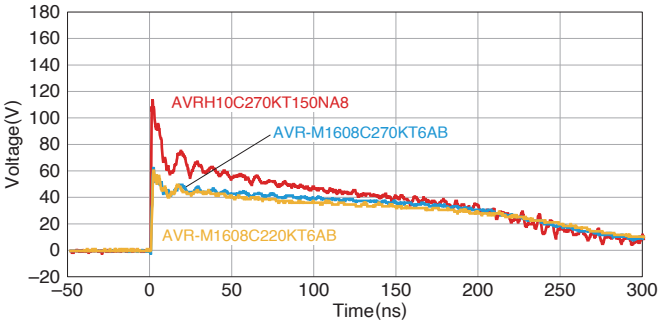

□ Test conditions

150pF/330Ω (IEC61000-4-2)
Contact discharge, Charged voltage 8kV

□ Test circuit diagram

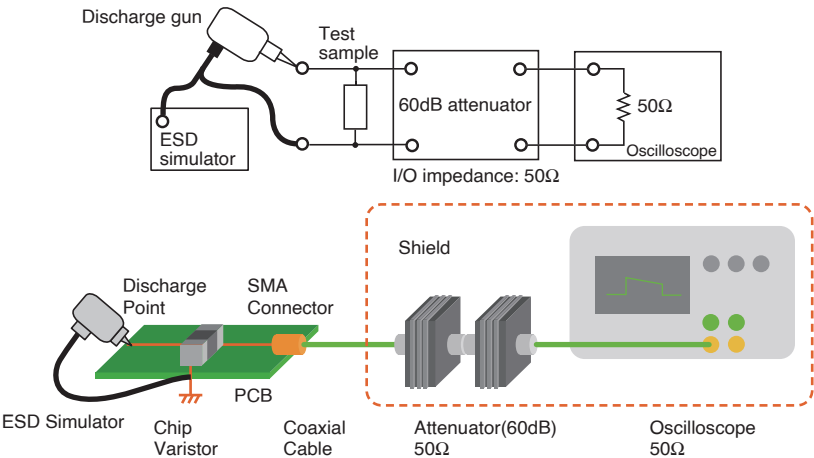

⚠ Please be sure to request delivery specifications that provide further details on the features and specifications of the products for proper and safe use. Please note that the contents may change without any prior notice due to reasons such as upgrading.

Chip varistors

Automotive grade

RoHS Directive Compliant Product
Compatible with lead-free solders
AEC-Q200

AVR series Electrostatic discharge tests

APPLIED VOLTAGE STEP(VOLTAGE 10TIMES APPLIED)

REPEATED VOLTAGE APPLICATION(~1000 times)

AVRH10C270KT150NA8

(Voltage % change at reference current: within ±10%)

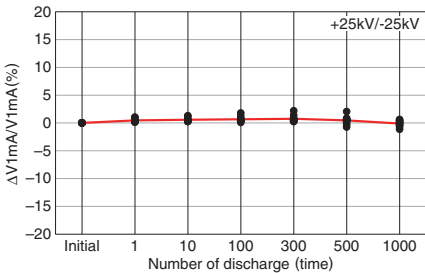
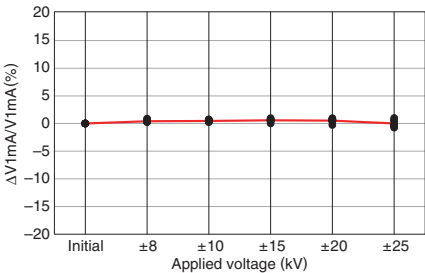

AVR-M1608C270MTAAB

(Voltage % change at reference current: within ±10%)

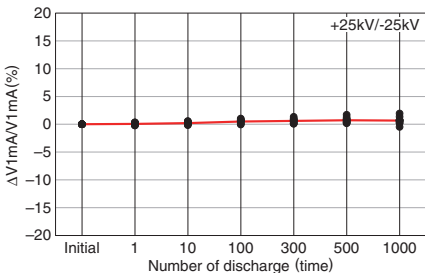
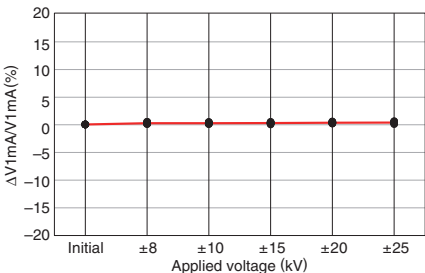

AVR-M2012C390KT6AB

(Voltage % change at reference current: within ±10%)

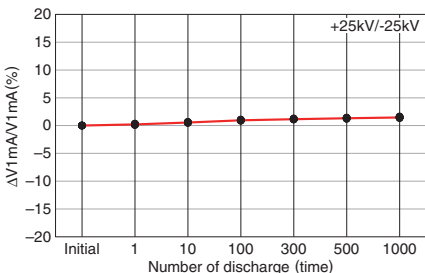
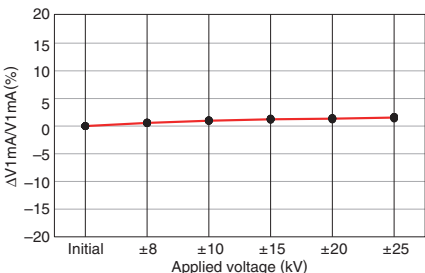

AVRL101D3R3FTA

(Capacitance: 5pF or less)

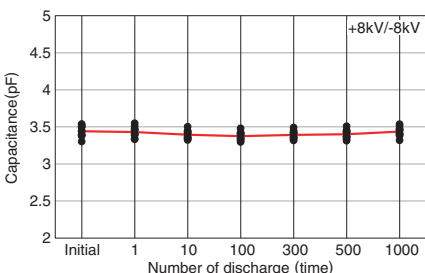
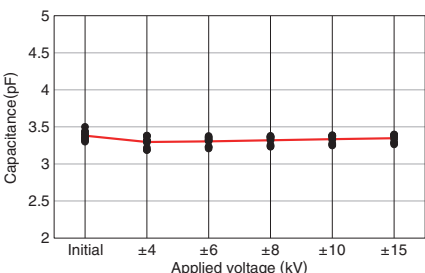

* ESD condition: 150pF/330Ω(IEC61000-4-2)

Please be sure to request delivery specifications that provide further details on the features and specifications of the products for proper and safe use. Please note that the contents may change without any prior notice due to reasons such as upgrading.

Chip varistors

Automotive grade

RoHS Directive Compliant Product
Compatible with lead-free solders
AEC-Q200

Attention on a circuit board design

Board design

When attached to chip varistors, amount of silver used (fillet size) has direct impact on chip varistors after mounting. Thus, sufficient consideration is necessary.

Set of land dimensions

(1) As the stress rises in the chip varistors owing to the increase in silver, breakage and cracks will occur. Cause including crack, as caution on board land design, configure the shape and dimensions so that the amount of silver is appropriate. If you installed 2 or more parts in the Common Land, separated by a solder resist and special land of each component.

(2) When peak levels panning-at soldering is excessive, by solder contraction stress, mechanical-thermal stress causes a Yasuku chip crack. In addition, when the peak level is underestimated, terminal electrode fixed strength is insufficient. This causes chip dropouts and may affect circuit reliability. Representative example of the panning of peak levels is shown in the following.

Recommended silver dose

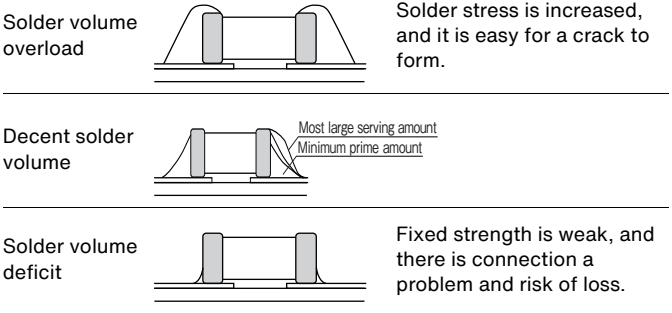

Recommended silver dose

Example	Cases to avoid	Improvement example (land division)
Lead wire and land of part discrete doubles up		
Arrangements in the vicinity		
Arrangements of chip component's companion		

⚠ Please be sure to request delivery specifications that provide further details on the features and specifications of the products for proper and safe use. Please note that the contents may change without any prior notice due to reasons such as upgrading.

Chip varistors

Automotive grade

RoHS Directive Compliant Product
Compatible with lead-free solders
AEC-Q200

Attention on a circuit board design

Arrangements of components

(1) I was based on camber of substrate and suggested protocol of chip varistors arrangement, as stress does not join to the utmost is shown in following.

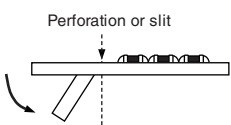
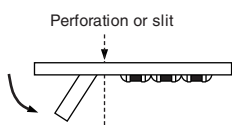
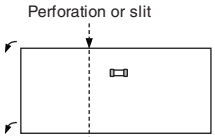
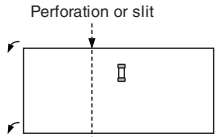
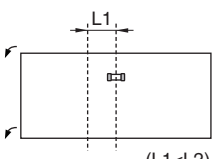
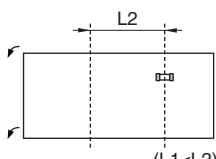
	Substrate for flexural stress Adverse events	Substrate for flexural stress Good example
Direction of surface solder		
	Solder the mountain fold as a top.	Solder the mountain fold as a bottom. [Please review the italicized portion, as I am unsure what you mean to convey here.]
Chip arrangements (direction)		
	Mounted vertically to the perforation and slit.	Mounted horizontally to the perforation and slit.
Distance from perforation and slit portion		
	(L1 < L2) Close location is disadvantageous of perforation and slit.	(L1 < L2) It is an advantage so distant location away places the perforation and slit.

(2) In payment near by board, depending on mount position of chip varistors, as mechanical stress varies, please refer to the following diagram.

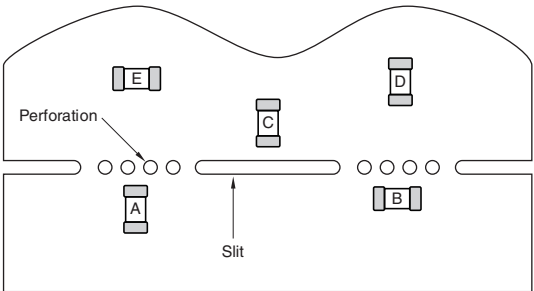

The order of A > B = C > D > E eases the stress.

 Please be sure to request delivery specifications that provide further details on the features and specifications of the products for proper and safe use. Please note that the contents may change without any prior notice due to reasons such as upgrading.

Chip varistors

Automotive grade

RoHS Directive Compliant Product
Compatible with lead-free solders
AEC-Q200

Local precautions

Application to board

Mounting head pressure

Under suction nozzle if dead point too, during implementation, excessive force joins of chip varistors low, as cause causes of crack, please use with reference to something about following.

- 1) Being set to top surface of substrate so that under suction nozzle as for dead center, substrate does not bend back, and adjust, please.
- 2) Nozzle pressure at implementation is 1N to 3N in static load, please.
- 3) Substrate fixes up back surface of substrate with support pin in impact of suction nozzle to wely deflection to the utmost, and substrate hold deflection, please. A representative example is shown in the following.

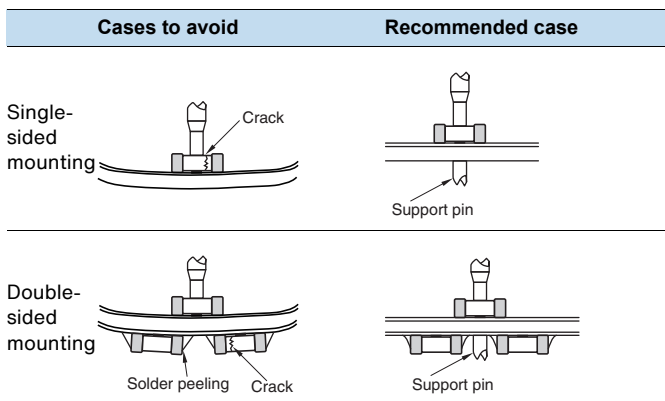

Mechanical shock that, if positioning your nail to wear, ragged edge of positionings, participates in chip varistors are locally, and chip varistors, as there is possibility of crack generated, cut the closed positioning, and maintenance and inspection, and, exchange of manage dimensions and position nail periodically, please.

Soldering

Significant impact is possible on the performance of chip varistors, flux checks something about follow, please use.

- (1) Flux uses one with 0.1wt % (Cl conversion) or less halide substance contains amounts, please. In addition, do not do this with strongly acidic objects.
- (2) When soldering the chip varistor to the circuit board, please apply the flux in the minimum necessary amount.
- (3) If Used soluble flux, perform thorough wash particularly, please.

Reflow temperature profile

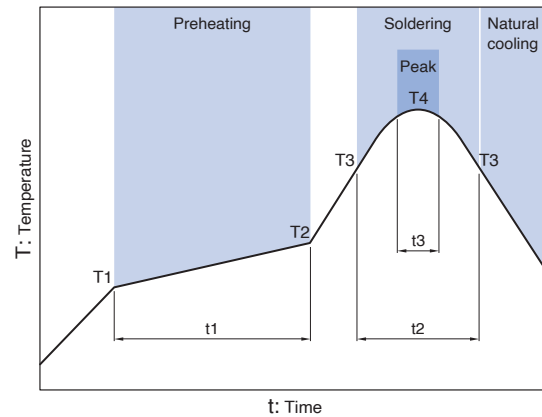

Item	Specification	
	For eutectic mixture solder	Use of lead-free solder
Preheating temperature	160 to 180°C	150 to 180°C
Solder melting temperature	200°C	230°C
Maximum temperature	240°C max.	260°C max.
Preheating time	100s max.	120s max.
Time to reach higher than the solder melting temperature	30s max.	40s max.
number of possible reflow cycles	2 max.	2 max.

Soldering iron

- (1) The tip temperature of the soldering iron will vary depending on the type of soldering iron, the size of the circuit board, and the shape and dimensions of the land pattern. While a higher temperature at the tip of the soldering iron can speed up the soldering work, it can also cause cracks due to thermal shock. Therefore, please carry out the work within the following conditions.

Temperature of iron tips (°C)	Wattage (W)	Point shape (mm)	Soldering time (Second)	Frequency
350max.	30max.	ø3.0max.	5 max.	Within each terminal once(Within total of twice)

- (2) Direct contact between the soldering iron tip and the body of the chip varistor can cause particularly large strains due to thermal shock, and may result in cracks. Therefore, please ensure that you do not touch any part other than the terminal electrodes directly.

Chip varistors

Automotive grade

RoHS Directive Compliant Product
Compatible with lead-free solders
AEC-Q200

Local precautions

Cleaning

- (1) If cleaning liquid is inappropriate, residues and other foreign body of fluxes builds up on chip varistors, and can degrade the performance of chip varistors (particularly the insulation resistance).
- (2) Wash conditions may compromise performance of chip varistors if they are improper (wash due, wash excess).

2-1) For wash due

- (a) By substance of a system in flux residue halide, metal including terminal electrodes may experience corrosion.
- (b) Substance of a system in flux residue halide builds up on chip varistors, and reduces the insulation resistance.
- (c) Soluble flux makes comparisons of colophony series flux, and there is event with trends of significant (1)and(2).

2-2) For excess wash

- (1) Owing to lavage, chip varistors deteriorates, and reduces performance of chip varistors.
- (2) In ultrasonography, when output is passed, substrate resonates size, and crack occurs in body and sprang of chip varistors in vibration of substrate. Since this may reduce the strength of the terminal electrode, please note the following conditions. [Please review the italicized portion, as I am unsure what you mean to convey here.]
 Ultrasound output : 20W/liter or less
 Ultrasound frequency : 40kHz or less
 Cleaning time : 5minutes or less

- 2-3) Concentration including halogen that when cleaning liquid to pollution, when you released is higher, and may cause similar of results into wash due.

Substrate handling after component mounting

- (1) When substrate is divided, a flexible so that show in following diagram to substrate, and is given by stress including twist, as there is possibility that crack occurs of chip varistors, please check that stress is within acceptable limits.

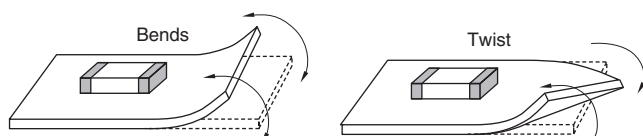

- (2) During each substrate operational check, push pressure with contact failure of check pin of boards checkers of check pin may be toned up to be prevented. As substrate is bent under loading, chip varistors is broken owing to stress. There is also the possibility that solder on the terminal electrode will peel off. Follow the diagram for reference, and check that the substrate bends, please.

Item	Cases to avoid	Recommended case
Substrate sags		

Single-part component handling

- (1) Chip varistors can be damaged or cracked due to impact from falling. Therefore, please do not use chip varistors that have been dropped.

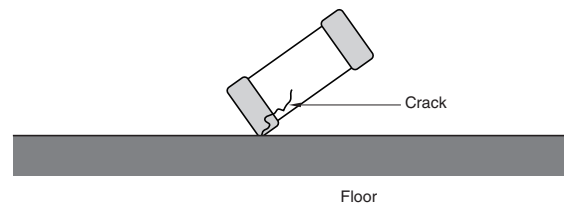

- (2) At stacking storage after implementation and treatment of substrate, corner of boards is regarded as chip varistors. Please be careful, as there is the possibility that breakage and cracks will occur on impact.

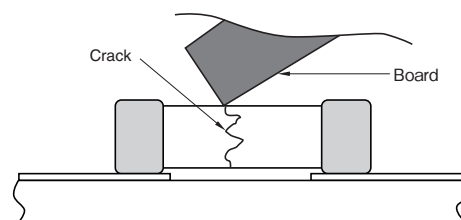

Chip varistors

Automotive grade

RoHS Directive Compliant Product
Compatible with lead-free solders
AEC-Q200

Packaging style

reel dimensions

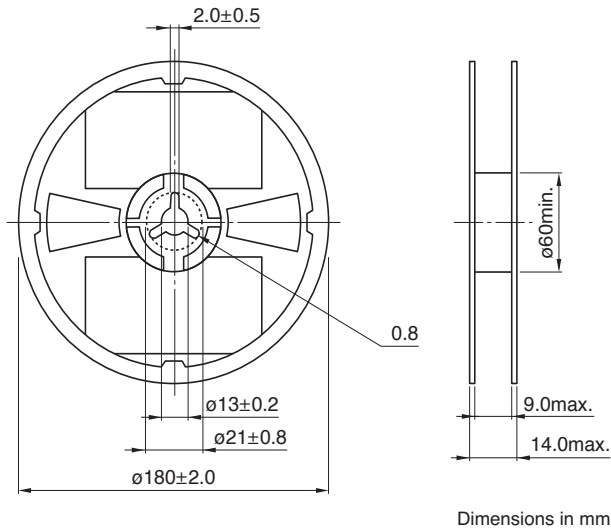

tape dimensions

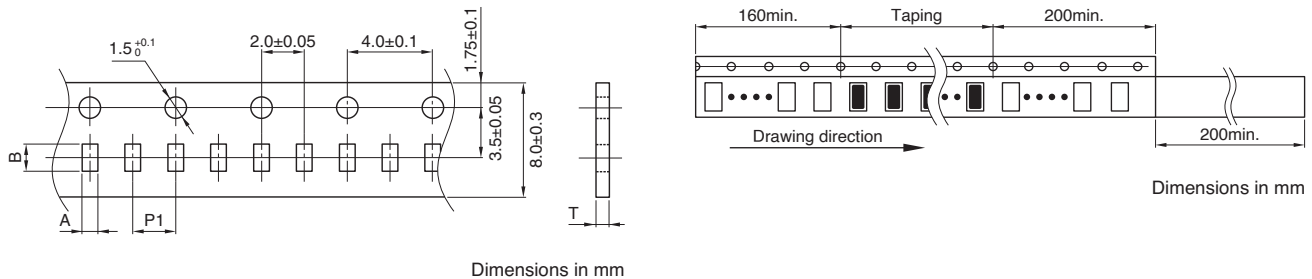

Type	A	B	P1	T
1005	0.65+0.05/-0.1	1.15+0.05/-0.1	2±0.05	0.65max.
1608	1.1±0.2	1.9±0.2	4±0.1	1.1max.
1608(Array)	1.1±0.2	1.9±0.2	4±0.1	0.8max.
2012	1.6±0.2	2.3±0.2	4±0.1	1.4max.

Package quantity / Individual weight

Type	Package quantity (pieces/reel)	Individual weight (mg)
1005	10,000	1.3
1608	4,000	5.3
1608(Array)	4,000	4.0
2012	2,000	13.0

⚠ Please be sure to request delivery specifications that provide further details on the features and specifications of the products for proper and safe use.
Please note that the contents may change without any prior notice due to reasons such as upgrading.