



3-terminal filters

For general signal line

MEM series

MEM1005PP_{type}

MEM1005PP **1005[0402 inch]***

* Dimensions code JIS[EIA]

REMINDERS FOR USING THESE PRODUCTS

Before using these products, be sure to request the delivery specifications.

SAFETY REMINDERS

Please pay sufficient attention to the warnings for safe designing when using this product.

REMINDERS

- The storage period is less than 12 months. Be sure to follow the storage conditions (temperature: 5 to 40°C, humidity: 10 to 75% RH or less).
If the storage period elapses, the soldering of the terminal electrodes may deteriorate.
- Do not use or store in locations where there are conditions such as gas corrosion (salt, acid, alkali, etc.).
- Before soldering, be sure to preheat components.
The preheating temperature should be set so that the temperature difference between the solder temperature and chip temperature does not exceed 150°C.
- Soldering corrections after mounting should be within the range of the conditions determined in the specifications.
If overheated, a short circuit, performance deterioration, or lifespan shortening may occur.
- When embedding a printed circuit board where a chip is mounted to a set, be sure that residual stress is not given to the chip due to the overall distortion of the printed circuit board and partial distortion such as at screw tightening portions.
- Self heating (temperature increase) occurs when the power is turned ON, so the tolerance should be sufficient for the set thermal design.
- Carefully lay out the coil for the circuit board design of the non-magnetic shield type.
A malfunction may occur due to magnetic interference.
- Use a wrist band to discharge static electricity in your body through the grounding wire.
- Do not expose the products to magnets or magnetic fields.
- Do not use for a purpose outside of the contents regulated in the delivery specifications.
- The products listed on this catalog are intended for use in general electronic equipment (AV equipment, telecommunications equipment, home appliances, amusement equipment, computer equipment, personal equipment, office equipment, measurement equipment, industrial robots) under a normal operation and use condition.
The products are not designed or warranted to meet the requirements of the applications listed below, whose performance and/or quality require a more stringent level of safety or reliability, or whose failure, malfunction or trouble could cause serious damage to society, person or property.
If you intend to use the products in the applications listed below or if you have special requirements exceeding the range or conditions set forth in the each catalog, please contact us.

- (1) Aerospace/aviation equipment
- (2) Transportation equipment (cars, electric trains, ships, etc.)
- (3) Medical equipment
- (4) Power-generation control equipment
- (5) Atomic energy-related equipment
- (6) Seabed equipment
- (7) Transportation control equipment

- (8) Public information-processing equipment
- (9) Military equipment
- (10) Electric heating apparatus, burning equipment
- (11) Disaster prevention/crime prevention equipment
- (12) Safety equipment
- (13) Other applications that are not considered general-purpose applications

When designing your equipment even for general-purpose applications, you are kindly requested to take into consideration securing protection circuit/device or providing backup circuits in your equipment.

3-terminal filters

For general signal line

Product compatible with RoHS directive
Halogen-free
Compatible with lead-free solders

Overview of MEM1005PP type

FEATURES

- Multilayer chip EMC filter.
- Monolithic structure makes it highly reliable.
- Has sharp attenuation characteristics with excellent EMC suppression.
- π -type circuit is used.
- Compact with a low profile design.
- PP type products are the new standard type products that have both large current and low resistance.

APPLICATION

Smart phones, tablet terminals, disclosed is a wireless communication device for base stations, etc. Note PC, various modules such as camera modules. DSCs, video games, portable memory audio devices, WLANs, SSDs

PART NUMBER CONSTRUCTION

MEM	1005	PP	251	T	001
Series name	LxWxT dimensions (mm)		Cutoff frequency (MHz)		internal code
	1005	1.0x0.5x0.35	251	250	T
	Product internal code		Packaging style		
	P		Taping		

OPERATING TEMPERATURE RANGE, PACKAGE QUANTITY, PRODUCT WEIGHT

Type	Temperature ranges		Package quantity (pieces/reel)	Individual weight (mg)
	Operating temperature (°C)	Storage temperature* (°C)		
MEM1005PP	-55 to +125°C	-55 to +125°C	10,000	0.6

* The storage temperature range is for after the assembly.

- RoHS Directive Compliant Product: See the following for more details.<https://product.tdk.com/info/en/environment/rohs/index.html>
- Halogen-free: Indicates that Cl content is less than 900ppm, Br content is less than 900ppm, and that the total Cl and Br content is less than 1500ppm.

 Please be sure to request delivery specifications that provide further details on the features and specifications of the products for proper and safe use. Please note that the contents may change without any prior notice due to reasons such as upgrading.

MEM1005PP type

RECOMMENDED REFLOW PROFILE

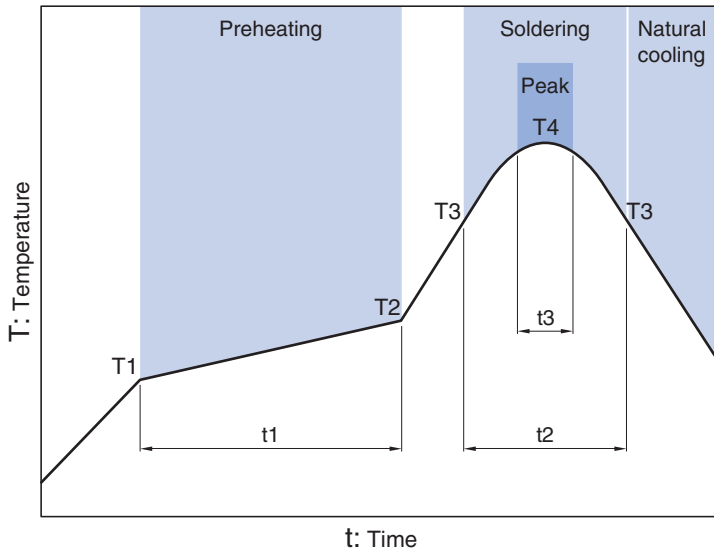

Preheating			Soldering		Peak	
Temp.		Time	Temp.	Time	Temp.	Time
T1	T2	t1	T3	t2	T4	t3
150°C	180°C	60 to 120s	230°C	30 to 60s	250 to 260°C	10s max.

MEM1005PP type

SHAPE & DIMENSIONS

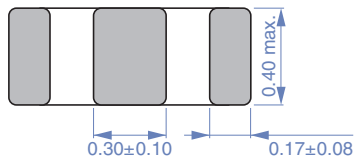
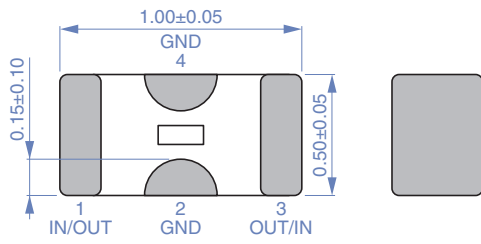



Dimensions in mm

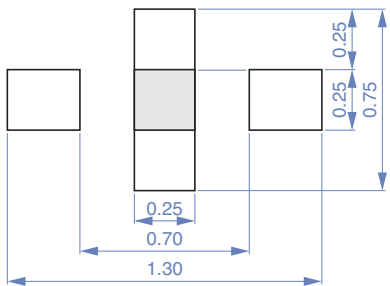

RECOMMENDED LAND PATTERN



Dimensions in mm

-  Land pattern
-  Land pattern + Solder resist

CIRCUIT DIAGRAM

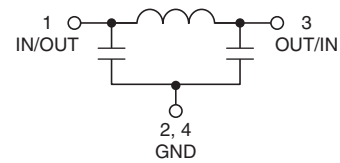

MEM1005PP type

ELECTRICAL CHARACTERISTICS

CHARACTERISTICS SPECIFICATION TABLES

Cutoff frequency (MHz)	Insertion loss (dB)	Rated voltage (V)max.	Rated current* (mA)max.	Part No.
250	30[700MHz to 3GHz]	10	350	MEM1005PP251T001

*Please refer to the graph of rated current vs. temperature characteristics (derating) about the rating current at 105°C or more in rated current.

○ Measurement equipment

Measurement item	Product No.	Manufacturer
frequency characteristics	N5230C	Keysight Technologies

* Equivalent measurement equipment may be used.

RATED CURRENT VS. TEMPERATURE CHARACTERISTICS (DERATING)

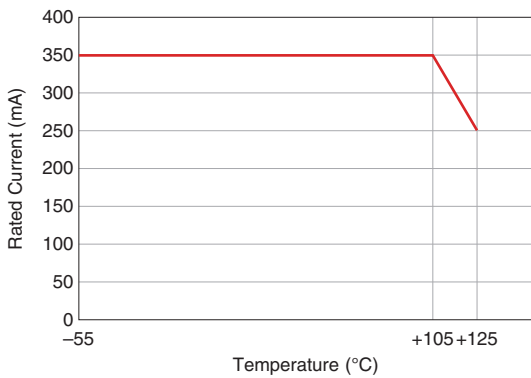

INSERTION LOSS VS. FREQUENCY CHARACTERISTICS

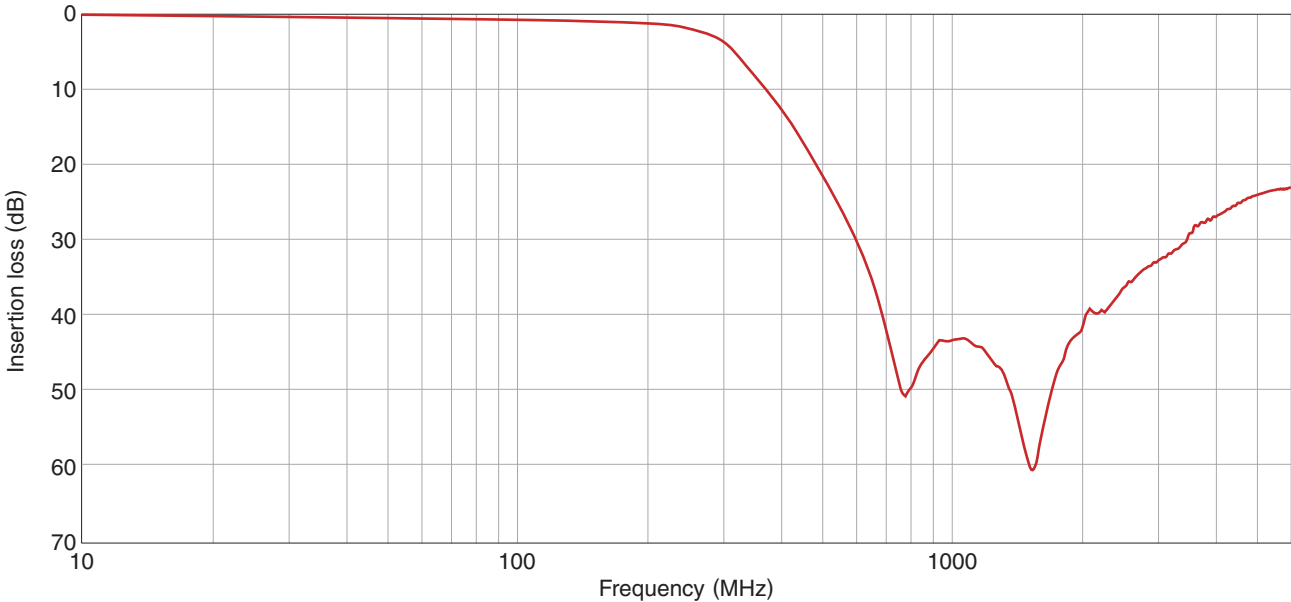

○ Measurement equipment

Product No.	Manufacturer
N5230C	Keysight Technologies

* Equivalent measurement equipment may be used.

 Please be sure to request delivery specifications that provide further details on the features and specifications of the products for proper and safe use. Please note that the contents may change without any prior notice due to reasons such as upgrading.

MEM1005PP type

PACKAGING STYLE

REEL DIMENSIONS

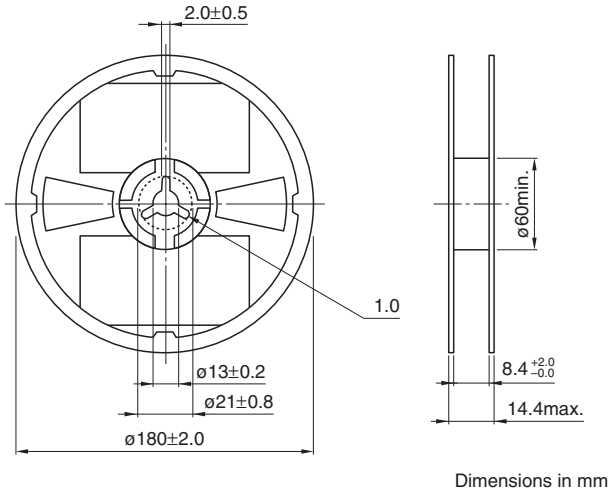

TAPE DIMENSIONS

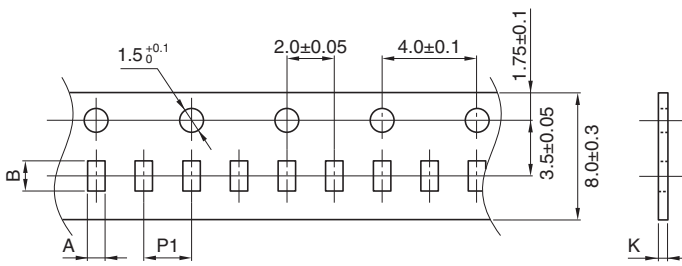

Type	A	B	P1	K
MEM1005PP	0.62±0.05	1.12±0.05	2.00±0.05	0.80max.

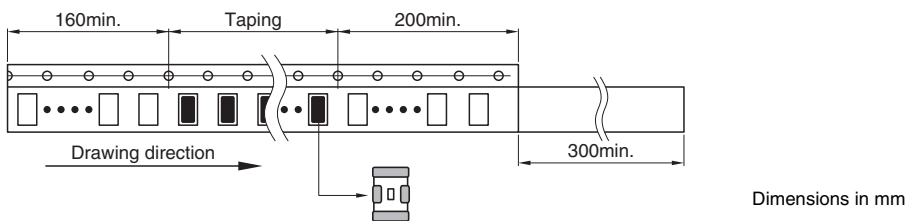

Please be sure to request delivery specifications that provide further details on the features and specifications of the products for proper and safe use. Please note that the contents may change without any prior notice due to reasons such as upgrading.