



# PiezoHapt™ Actuators

For automotive

## PHU series

---

PHUB8060-35A-33-000

### **Caution**

**Products in this catalog are in preparation for mass production.**

---

## REMINDERS FOR USING THESE PRODUCTS

Before using these products, be sure to request the delivery specifications.

### SAFETY REMINDERS

Please pay sufficient attention to the warnings for safe designing when using this products.

#### REMINDERS

- In use of this product, it should be minded by notes and please perform a safety design, after checking the individual standard for every unit enough.
- Do not apply DC bias to the product. In addition, the insulation resistance may be reduced and the function may not be performed.
- Use piezoelectric devices so that moisture-containing substances and water droplets do not come into contact with each other.
- There is a risk of performance degradation, adhere to the following matters.
  - Store the product in a packaged condition to avoid sudden temperature changes, condensation, direct sunlight, corrosive gas, dust, and dust. Use within six months.
  - Do not apply strong shocks (fall etc.) or pressure by which a crack goes into a product.
  - Do not supply any voltage higher than applicable to the product.
  - Do not use the piezoelectric buzzer outdoors. It is designed for indoor use.
  - Do not apply the temperature more than 150°C.
- When designing your equipment even for general-purpose applications, you are kindly requested to take into consideration securing protection circuit/device or providing backup circuits in your equipment.
- Do not wash the product in such a way that solvent or gas can penetrate the product.
- Handle piezoelectric devices with care so that they do not touch them by hand. It can cause corrosion and the charge being charged may be discharged to the hands.
- Discharge the product before connecting it to the measuring instrument.
- Do not remove the piezoelectric element from the diaphragm.
- When soldering, be careful not to attach flux or other foreign matter to the piezoelectric device.
- When soldering a terminal pin, perform the soldering in clean conditions without contamination or rust in order to avoid poor connections.
- Check the resonant frequency in the mounting condition, and use the product within the range where the resonant frequency is not affected by the resonance with a reference value of 1/2 or less of the resonant frequency.
- When fixing the product by adhesion, etc., investigate the type, amount, adhesion, etc. of the adhesive, conduct a reliability evaluation test, and confirm that there are no abnormalities.
- Do not use the product on a device that allows consumers to touch the product.
- Do not rework the product.
- The characteristics may vary depending on the shape and location of the mounting part. Check the mounted condition.
- Please take appropriate measures such as acquiring protective circuits and devices that meet the uses, applications, and conditions of the instruments and keeping backup circuits.
- We are not liable for any damage caused by the use of equipment (automobiles, aircraft, medical equipment, nuclear power equipment, etc.) that requires high safety and reliability, or that may cause damage to human life, body, property, etc., or that may have a significant social impact due to a product failure, malfunction, or failure, as well as the use of the product beyond the scope and conditions of this catalog.
- Do not use it in the following environments
  - Corrosive gases (Cl<sub>2</sub>, NH<sub>3</sub>, H<sub>2</sub>S, SO<sub>x</sub>, NO<sub>x</sub>, etc.)
  - Environments with highly conductive substances (electrolytes, water, saltwater, etc.)
  - Environments with acid, alkali, or organic solvents
  - Places to be exposed to dust.

# PiezoHapt™ actuators

For automotive

## Overview of the PHU series

### FEATURES

- It is thin and can support various application.
- It is possible to obtain a clear response by low-voltage drive.
- It answers in an instant and can respond to a variegated vibration pattern (vibrational frequency).
- This is a highly reliable type suitable for use in automotive equipment.

### APPLICATION

Touchpad for automotive equipment, displays etc.

### DRIVE CIRCUIT BLOCK DIAGRAM EXAMPLE

#### Discrete

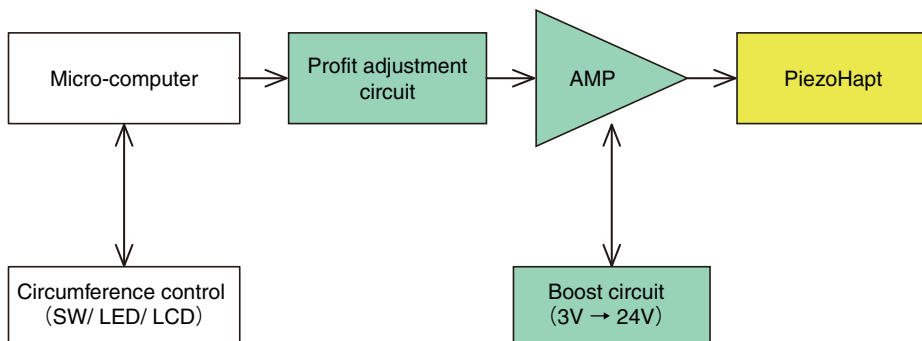

#### Haptic driver IC

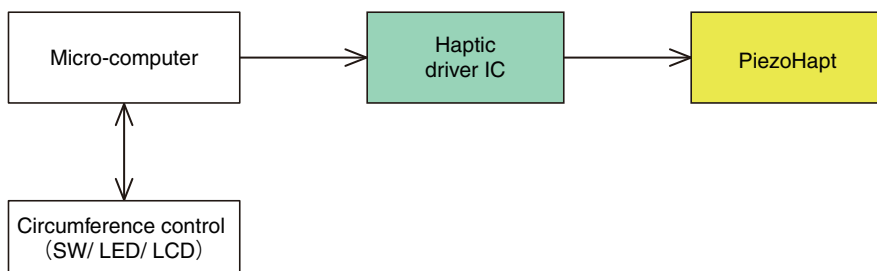

# Overview of the PHU series

## ■ PART NUMBER CONSTRUCTION

PHU	B	8060	-	35	A	-	33	-	000
Series name	Application	External vibration plate dimensions (LxW)		Total thickness		Type	External piezoelectric element dimensions (LxW)		Internal code
	A For general use	8060	80×60mm	35	0.35mm	A	42Ni-Fe + FPC	33	30×30mm
	B For automotive	3015	30×15mm	30	0.30mm			21	20×10mm

## ■ PRODUCT LINEUP

### □ SPECIFICATIONS

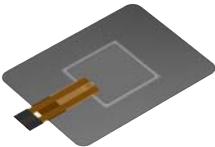
Part No.	PHUB8060-35A-33-000		
			
Dimensions	Vibration plate (mm)	80×60×0.25	
	Element (mm)	30×30×0.1	
Vibration plate specifications	42Ni-Fe		
Electrode specification	FPC		

### □ CHARACTERISTICS

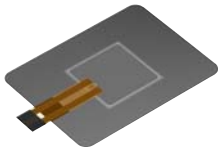
Part No.	PHUB8060-35A-33-000		
			
Application	Touchpad Displays		
Operation voltage	24V <sub>P-P</sub> (±12V)max.		
Operating temperature range	-40 to +105°C		

# PHUB8060-35A-33-000

## APPLICATION

- Suitable for touch panel of automotive equipment and display.

## SHAPE & DIMENSIONS

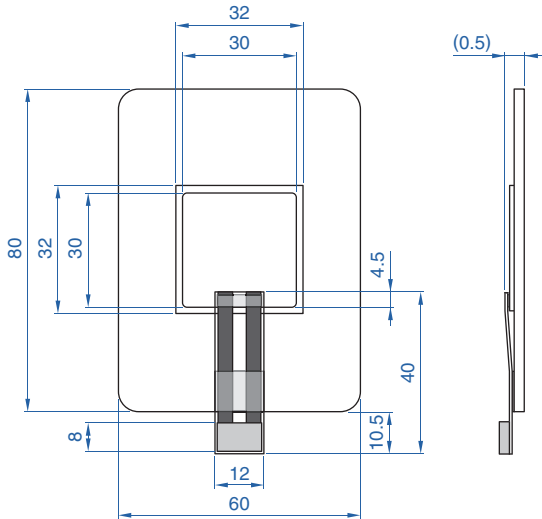

Dimensions in mm

## RECOMMENDED WIRING

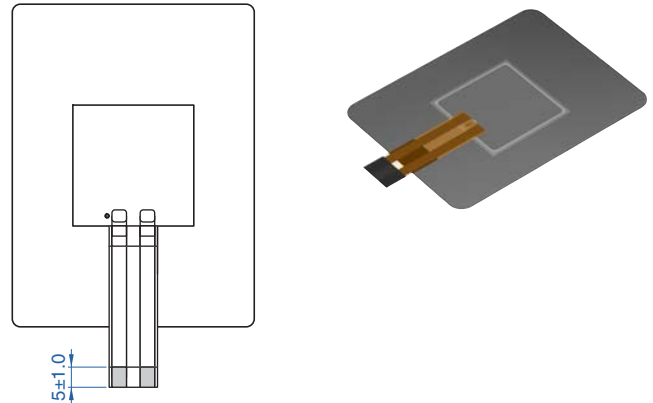

- Product shape are subject to change without notice.

## SPECIFICATIONS

<b>Vibration plate specifications</b>		42Ni-Fe
<b>Electrode specification</b>	<b>FPC</b>	
	<b>Width</b>	12mm
	<b>Number of cores</b>	2
	<b>Insulation length</b>	30mm
	<b>Lead pitch</b>	7.0mm
	<b>Stripping length</b>	5.0mm
	<b>Reinforcement</b>	8.0mm
<b>Operation voltage</b>		24V <sub>P-P</sub> (±12V)max.
<b>Operating temperature range</b>		-40 to +105°C

# PHU series

## ■ PACKAGING STYLE/PACKING NUMBER/MINIMUM ORDERING UNIT

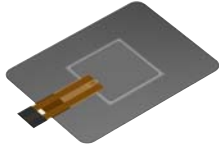
	PHUB8060-35A-33-000
	
<b>Packaging style</b>	Bulk (Tray)
<b>Packing number</b>	200 pieces / corrugated cardboard (20 trays containing 10 pieces)
<b>Minimum ordering unit</b>	200 pieces (1 boxes of corrugated cardboard containing 200 piece)

### □ Tray

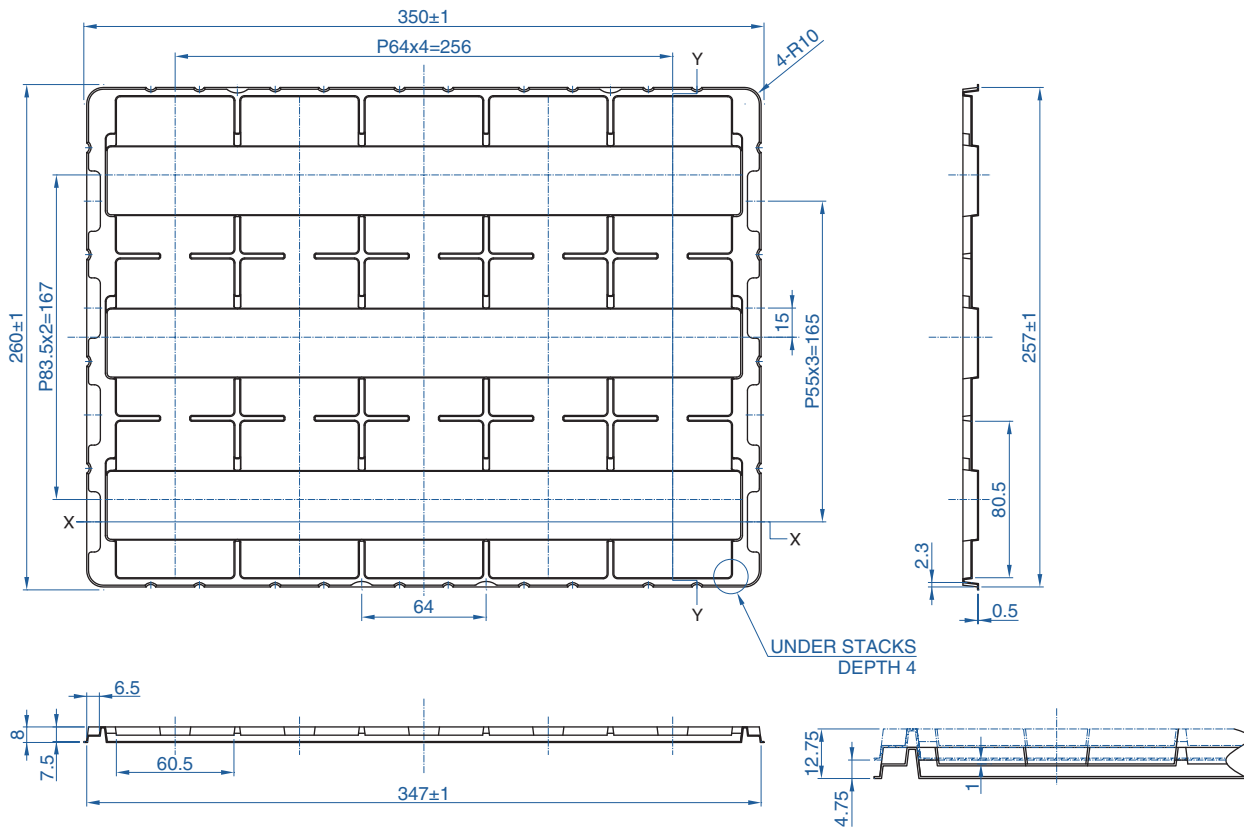

⚠ Please be sure to request delivery specifications that provide further details on the features and specifications of the products for proper and safe use. Please note that the contents may change without any prior notice due to reasons such as upgrading.