

# DELIVERY SPECIFICATION

SPEC. No. D2018-FA

D A T E : 2018 Aug.

To

## Non-Controlled Copy

CUSTOMER'S PRODUCT NAME

TDK'S PRODUCT NAME

Multilayer Ceramic Capacitors

Dipped Radial Lead Type

FA-Series

General (Up to 50V)

Mid voltage (100 to 630V)

【Halogen-free】

Please return this specification to TDK representatives with your signature.

If orders are placed without returned specification, please allow us to judge that specification is accepted by your side.

## RECEIPT CONFIRMATION

DATE:                      YEAR                      MONTH                      DAY

TDK Corporation

Sales

Electronic Components

Sales & Marketing Group

Engineering

Electronic Components Business Company

Ceramic Capacitors Business Group

APPROVED	Person in charge

APPROVED	CHECKED	Person in charge

## 1. SCOPE

This specification is applicable to multilayer ceramic capacitors dipped radial lead type with a priority over the other relevant specifications.

Production places defined in this specification shall be TDK Xiamen Co., Ltd. (China).

### EXPLANATORY NOTE:

This specification warrants the quality of the lead type ceramic capacitor. The parts should be evaluated or confirmed a state of used on your product.

If the use of the parts go beyond the bounds of the specification, we can not afford to guarantee.

## 2. CODE CONSTRUCTION

(Example)  $\frac{FA28}{(1)}$      $\frac{X7R}{(2)}$      $\frac{1H}{(3)}$      $\frac{104}{(4)}$      $\frac{K}{(5)}$      $\frac{NU0}{(6)}$      $\frac{6}{(7)}$

(1)Type

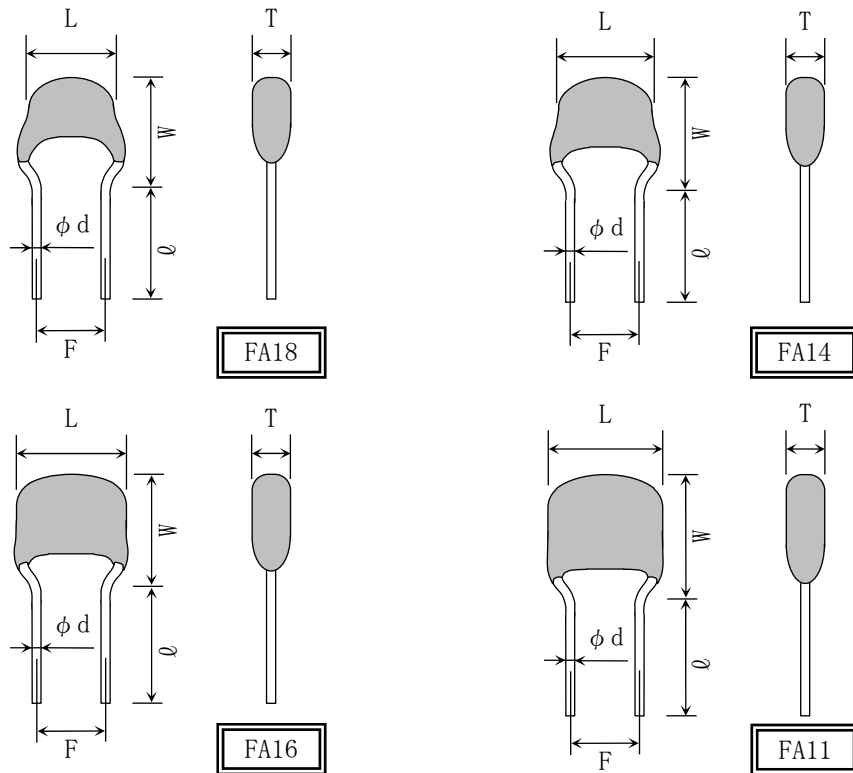

Type	Dimensions (Unit : mm)					
	L(max.)	W(max.)	T(max.)	F	l	phi d
FA18	4.0	5.5	2.5	2.5±0.8	7.0±2.0	0.5 +0.10 -0.03
FA14	4.5	5.5	3.0			
FA16	5.5	6.0	3.5			
FA11	5.5	7.0	4.0			

\*FA denotes forming lead.

The first digit refers to a distance between leads ( 1-2.5mm ),  
the second digit is for TDK internal code.

\*Dimension F and l is applied to bulk packaging.

Refer to Appendix 2 for dimension of taping packaging.

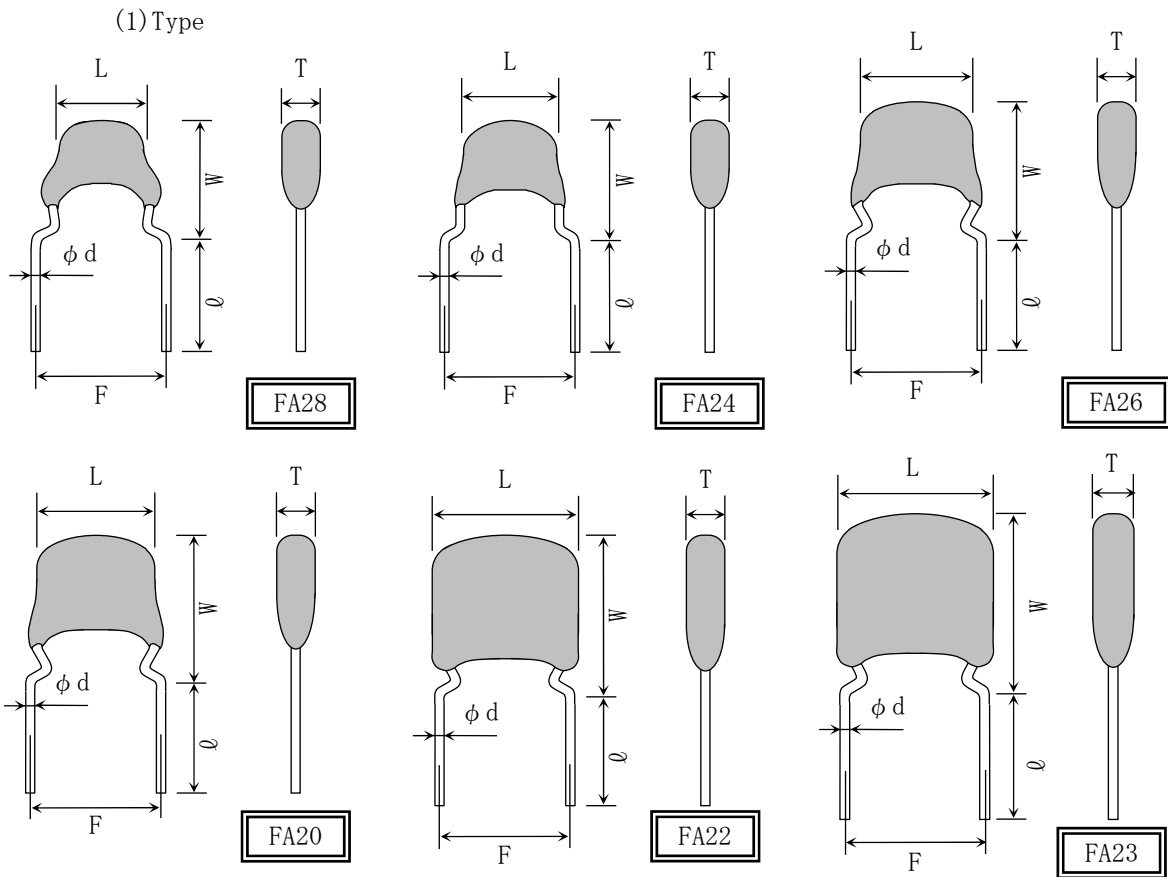

Type	Dimensions (Unit : mm)					
	L(max.)	W(max.)	T(max.)	F	l	ϕ d
FA28	4.0	5.5	2.5	5.0±1.0	7.0±2.0	0.5
FA24	4.5	5.5	3.0			
FA26	5.5	6.0	3.5			
FA20	5.5	7.0	4.0			
FA22	7.5	8.5	4.5			
FA23	8.5	11.0	5.5			

\*FA denotes forming lead.

The first digit refers to a distance between leads ( 2—5.0mm ),  
the second digit is for TDK internal code.

\*Dimension F and l is applied to bulk packaging.

Refer to Appendix 3 for dimension of taping packaging.

(2)Temperature Characteristics (Details are shown in para 7 No.7,8)

(3) Rated Voltage

Symbol	Rated Voltage
2 J	DC 630 V
2 W	DC 450 V
2 E	DC 250 V
2 A	DC 100 V
1 H	DC 50 V
1 E	DC 25 V

(4) Rated Capacitance

Stated in three digits and in units of pico farads (pF). The first and second digits identify the first and second significant figures of the capacitance, the third digit identifies the multiplier.

R is designated for a decimal point.

Example      2R2 → 2.2pF  
                 104 → 100,000pF

(5) Capacitance tolerance

Symbol	Tolerance	Capacitance (C)
C	±0.25 pF	$C \leq 5\text{pF}$
D	±0.5 pF	$5\text{pF} < C \leq 10\text{pF}$
J	± 5 %	Over 10pF
K	±10 %	
M	±20 %	

(6) Internal code

Symbol	Applied voltage of Life
NU0	Rated voltage ×2 (*1)
RU0	Rated voltage ×1

\*1 2E : Rated voltage ×1.5  
2W : Rated voltage ×1.2  
2J : Rated voltage ×1.2

(7) Packaging

Symbol	Packaging
0	Bulk
6	Ammo Pack

### 3.1 Standard combination of rated capacitances and tolerances

Class	Temperature Characteristics	Capacitance tolerance (*1)		Rated capacitance
1	COG	$1 \leq C \leq 5$	C ( $\pm 0.25$ pF)	E- 6 series
		$5 < C \leq 10$	D ( $\pm 0.5$ pF)	E- 6 series
		$10 < C \leq 100$	J ( $\pm 5$ %)	E- 6 series
		$100 < C \leq 10,000$	J ( $\pm 5$ %)	E-12 series
		$10,000 < C$	J ( $\pm 5$ %)	E- 6 series
2	X7R X7S X7T	$C \leq 0.1$	K ( $\pm 10$ %)	E- 6 series
		$0.1 < C \leq 10$	K ( $\pm 10$ %)	E- 6 series
		$10 < C$	M ( $\pm 20$ %)	E- 6 series

\*1 C denotes Capacitance.

Unit : pF for Class1 and  $\mu$ F for Class2.

### 3.2 Capacitance Step in E series

E series	Capacitance Step											
E- 6	1.0		1.5		2.2		3.3		4.7		6.8	
E-12	1.0	1.2	1.5	1.8	2.2	2.7	3.3	3.9	4.7	5.6	6.8	8.2

## 4. OPERATING TEMPERATURE RANGE

T. C.	Min. operating Temperature	Max. operating Temperature	Reference Temperature
COG X7R X7S X7T	-55°C	125°C	25°C

## 5. STORING CONDITION AND TERM

5 to 40°C at 20 to 70%RH

6 months Max.

## 6. INDUSTRIAL WASTE DISPOSAL

Dispose this product as industrial waste in accordance with the industrial Waste Law.

## 7. PERFORMANCE

table 1

No.	Item		Performance	Test or inspection method															
1	External Appearance		No defects which may affect performance.	By visual checking.															
2	Indication	Appearance	Meet a requirement per para 8.	solvent	Solvent temp.	Dipping time													
		Resistance to solvent	Shall be visible.	Isopropyl alcohol	20~25 °C	30±5s.													
3	Voltage Proof	Between termination	No insulation breakdown or other damage.	<table border="1"> <thead> <tr> <th>Class</th> <th>Rated voltage</th> <th>Apply voltage</th> </tr> </thead> <tbody> <tr> <td rowspan="2">1</td> <td>100V and under</td> <td>3 × rated voltage</td> </tr> <tr> <td>Over 100V</td> <td>1.5 × rated voltage</td> </tr> <tr> <td rowspan="2">2</td> <td>RV≤100V</td> <td>2.5 × rated voltage</td> </tr> <tr> <td>Over 100V</td> <td>1.5 × rated voltage</td> </tr> </tbody> </table> <p>Above DC voltage shall be applied for 1~5s. Charge / discharge current shall not exceed 50mA.</p>			Class	Rated voltage	Apply voltage	1	100V and under	3 × rated voltage	Over 100V	1.5 × rated voltage	2	RV≤100V	2.5 × rated voltage	Over 100V	1.5 × rated voltage
		Class	Rated voltage	Apply voltage															
1	100V and under	3 × rated voltage																	
	Over 100V	1.5 × rated voltage																	
2	RV≤100V	2.5 × rated voltage																	
	Over 100V	1.5 × rated voltage																	
	Between termination coating	No insulation breakdown or other damage.	Apply ×2.5 rated voltage. (By metallic small ball method.)																
4	Insulation Resistance		10,000MΩ or 500 MΩ · μF min. whichever smaller.	«450V DC and under» Apply rated voltage. «630V DC» Apply DC500V. Applying time : 60sec.															
5	Capacitance		Within the specified tolerance.	Class 1															
				Rated capacitance	Measuring frequency	Measuring voltage													
			1,000pF and under	1MHz ± 10%	0.5~5 Vrms.														
			Over 1,000pF	1kHz ± 10%															
			Class 2																
			Rated capacitance	Measuring frequency	Measuring voltage														
			10 μF and under	1kHz ± 10%	1.0±0.2 Vrms.														
			Over 10 μF	120Hz ± 10%	0.5±0.2 Vrms.														
			For information which product has which measuring voltage, please contact with our sales representative.																

(continued)

No.	Item		Performance	Test or inspection method															
6	Q (Class 1)		<table border="1"> <thead> <tr> <th>Capacitance</th> <th>Q</th> </tr> </thead> <tbody> <tr> <td>30pF and over</td> <td>1,000 min.</td> </tr> <tr> <td>Under 30pF</td> <td>400+20×C min.</td> </tr> <tr> <td colspan="2">C : Rated capacitance (pF)</td> </tr> </tbody> </table>	Capacitance	Q	30pF and over	1,000 min.	Under 30pF	400+20×C min.	C : Rated capacitance (pF)		<p>See No. 5 in this table for measuring condition.</p> <p>For information which product has which Dissipation Factor, please contact with our sales representative.</p>							
	Capacitance	Q																	
30pF and over	1,000 min.																		
Under 30pF	400+20×C min.																		
C : Rated capacitance (pF)																			
Dissipation Factor (Class 2)		<table border="1"> <thead> <tr> <th>T. C.</th> <th>D. F.</th> </tr> </thead> <tbody> <tr> <td>X7R</td> <td>0.03 max.</td> </tr> <tr> <td>X7S</td> <td>0.05 max.</td> </tr> <tr> <td>X7T</td> <td>0.075 max.</td> </tr> </tbody> </table>	T. C.	D. F.	X7R	0.03 max.	X7S	0.05 max.	X7T	0.075 max.									
T. C.	D. F.																		
X7R	0.03 max.																		
X7S	0.05 max.																		
X7T	0.075 max.																		
7	Temperature Characteristics of Capacitance (Class 1)		<table border="1"> <thead> <tr> <th>Temperature Coefficient (ppm/°C)</th> </tr> </thead> <tbody> <tr> <td>COG : 0 ± 30</td> </tr> </tbody> </table> <p>Capacitance drift Within ±0.2% or ±0.05pF, whichever larger.</p>	Temperature Coefficient (ppm/°C)	COG : 0 ± 30	<p>Temperature Coefficient shall be calculated based on values at 25°C and 85°C temperature.</p> <p>Measuring temperature below 20°C shall be -10°C and -25°C</p>													
Temperature Coefficient (ppm/°C)																			
COG : 0 ± 30																			
8	Temperature Characteristics of Capacitance (Class 2)		<table border="1"> <thead> <tr> <th>Capacitance Change (%)</th> </tr> <tr> <th>No voltage applied</th> </tr> </thead> <tbody> <tr> <td>X7R : ±15</td> </tr> <tr> <td>X7S : ±22</td> </tr> <tr> <td>X7T : +22, -33</td> </tr> </tbody> </table>	Capacitance Change (%)	No voltage applied	X7R : ±15	X7S : ±22	X7T : +22, -33	<p>Capacitance shall be measured by the steps shown in the following table, after thermal equilibrium is obtained for each step. ΔC be calculated ref. STEP3 reading.</p> <table border="1"> <thead> <tr> <th>Step</th> <th>Temperature (°C)</th> </tr> </thead> <tbody> <tr> <td>1</td> <td>Reference temp. ±2</td> </tr> <tr> <td>2</td> <td>Min. operating temp. ±2</td> </tr> <tr> <td>3</td> <td>Reference temp. ±2</td> </tr> <tr> <td>4</td> <td>Max. operating temp. ±2</td> </tr> </tbody> </table> <p>Measuring voltage: 0.5, 1.0Vrms. For information which product has which applied voltage, please contact with our sales representative.</p>	Step	Temperature (°C)	1	Reference temp. ±2	2	Min. operating temp. ±2	3	Reference temp. ±2	4	Max. operating temp. ±2
Capacitance Change (%)																			
No voltage applied																			
X7R : ±15																			
X7S : ±22																			
X7T : +22, -33																			
Step	Temperature (°C)																		
1	Reference temp. ±2																		
2	Min. operating temp. ±2																		
3	Reference temp. ±2																		
4	Max. operating temp. ±2																		
9	Lead Strength	Tensile Strength	No mechanical damage such as lead breakage and loosening.	<p>With holding the parts, apply pulling force to lead drawing direction gradually. Pulling strength : 10N Holding time : 10±1s.</p> <p>With holding the capacitors to keep the axis vertical, bend it 90 degrees with weighting and put it back to the original position. This operation shall be done for 2~3s. and repeat the following times. Bending forth : 5N Testing time : 2 times</p>															
		Bending Strength	No mechanical damage such as lead breakage and loosening.																

(continued)

No.	Item		Performance	Test or inspection method		
10	Mechanical Shock	External appearance	No mechanical damage.	Solder the capacitors on a P.C.Board shown in Appendix1 before testing.  With following conditions.  Waveform : Half-sine Applied force : 100G max. Velocity change : 12.3ft/s. Duration : 6 msec. Shocks : 18shocks in each 3 mutually perpendicular axes.		
		Capacitance	Characteristics		Change from the value before test	
			Class1		COG	$\pm 2.5\%$ or $\pm 0.25\text{pF}$ , whichever larger.
			Class2		X7R X7S X7T	$\pm 7.5\%$
Q Class1	Meet the initial spec.					
D.F. Class2	Meet the initial spec.					
11	Vibration	External appearance	No mechanical damage.	Solder the capacitors on a P.C.Board shown in Appendix1 before testing.  Vibrate the capacitor with following conditions.  Applied force : 5G max. Frequency : 10-2,000-10Hz Duration : 20 min. Cycle : 12cycles in each 3 mutually perpendicular directions.		
		Capacitance	Characteristics		Change from the value before test	
			Class1		COG	$\pm 2.5\%$ or $\pm 0.25\text{pF}$ , whichever larger.
			Class2		X7R X7S X7T	$\pm 7.5\%$
Q Class1	Meet the initial spec.					
D.F. Class2	Meet the initial spec.					
12	Solderability		Leads shall be covered by new solder more than 75% of its surface.	Completely soak both terminations in solder at $245\pm 5^{\circ}\text{C}$ for $2\pm 0.5\text{s}$ .  Solder : Sn-3.0Ag-0.5Cu(Pb-free) Flux : Isopropyl alcohol (JIS K 8839) Rosin (JIS K 5902) 25% solid solution. Dipping : By 1.5~2.0mm from the root of lead.		
13	Resistance to solder heat	External appearance	No defects which may affect performance.	Completely soak both terminations in solder at $260\pm 5^{\circ}\text{C}$ for $10\pm 1\text{s}$ .  Solder : Sn-3.0Ag-0.5Cu(Pb-free) Flux : Isopropyl alcohol (JIS K 8839) Rosin (JIS K 5902) 25% solid solution. Dipping : By 1.5~2.0mm from the root of lead.  Leave the capacitors in ambient condition for the following time before measurement.  Class1 : 6~24h Class2 : 24 $\pm$ 2h		
		Capacitance	Characteristics		Change from the value before test	
			Class1		COG	$\pm 2.5\%$ or $\pm 0.25\text{pF}$ whichever larger.
			Class2		X7R X7S X7T	$\pm 7.5\%$
		Q Class1	Meet the initial spec.			
		D.F. Class2	Meet the initial spec.			
Insulation Resistance	Meet the initial spec.					
Voltage proof	No insulation breakdown or other damage.					



(continued)

No.	Item	Performance	Test or inspection method									
14	Heat shock	External appearance	No mechanical damage.									
		Capacitance	<table border="1"> <thead> <tr> <th colspan="2">Characteristics</th> <th>Change from the value before test</th> </tr> </thead> <tbody> <tr> <td>Class1</td> <td>COG</td> <td><math>\pm 2.5\%</math> or <math>\pm 0.25\text{pF}</math> whichever larger.</td> </tr> <tr> <td>Class2</td> <td>X7R X7S X7T</td> <td><math>\pm 7.5\%</math></td> </tr> </tbody> </table>	Characteristics		Change from the value before test	Class1	COG	$\pm 2.5\%$ or $\pm 0.25\text{pF}$ whichever larger.	Class2	X7R X7S X7T	$\pm 7.5\%$
			Characteristics		Change from the value before test							
			Class1	COG	$\pm 2.5\%$ or $\pm 0.25\text{pF}$ whichever larger.							
		Class2	X7R X7S X7T	$\pm 7.5\%$								
		Q Class1	Meet the initial spec.									
D.F Class2	Meet the initial spec.											
Insulation Resistance	Meet the initial spec.											
Voltage proof	No insulation breakdown or other damage.											
15	Moisture Resistance	External appearance	No mechanical damage.									
		Capacitance	<table border="1"> <thead> <tr> <th colspan="2">Characteristics</th> <th>Change from the value before test</th> </tr> </thead> <tbody> <tr> <td>Class1</td> <td>COG</td> <td><math>\pm 7.5\%</math> or <math>\pm 0.75\text{pF}</math> whichever larger.</td> </tr> <tr> <td>*Class2</td> <td>X7R X7S X7T</td> <td><math>\pm 12.5\%</math> <math>\pm 25\%</math></td> </tr> </tbody> </table> <p>*Applied for some parts</p>	Characteristics		Change from the value before test	Class1	COG	$\pm 7.5\%$ or $\pm 0.75\text{pF}$ whichever larger.	*Class2	X7R X7S X7T	$\pm 12.5\%$ $\pm 25\%$
			Characteristics		Change from the value before test							
			Class1	COG	$\pm 7.5\%$ or $\pm 0.75\text{pF}$ whichever larger.							
		*Class2	X7R X7S X7T	$\pm 12.5\%$ $\pm 25\%$								
		Q Class1	<table border="1"> <thead> <tr> <th>Capacitance</th> <th>Q</th> </tr> </thead> <tbody> <tr> <td>30pF and over</td> <td>200 min.</td> </tr> <tr> <td>Under 30pF</td> <td><math>100+10/3 \times C</math> min.</td> </tr> </tbody> </table> <p>C : Rated capacitance (pF)</p>	Capacitance	Q	30pF and over	200 min.	Under 30pF	$100+10/3 \times C$ min.			
Capacitance	Q											
30pF and over	200 min.											
Under 30pF	$100+10/3 \times C$ min.											
D.F. Class2	200% of initial spec max.											
Insulation Resistance	$500\text{M}\Omega$ or $25\text{M}\Omega \cdot \mu\text{F}$ min. whichever smaller.											
			<p>Solder the capacitors on a P.C. Board shown in Appendix1 before testing.</p> <p>Expose the capacitors in the condition step1 through 2.</p> <table border="1"> <thead> <tr> <th>Step</th> <th>Temp. (°C)</th> <th>Time(min.)</th> </tr> </thead> <tbody> <tr> <td>1</td> <td>Min. operating Temp. <math>\pm 3</math></td> <td><math>30 \pm 3</math></td> </tr> <tr> <td>2</td> <td>Max. operating Temp. <math>\pm 2</math></td> <td><math>30 \pm 2</math></td> </tr> </tbody> </table> <p>Test cycle : 1,000cycles Transit time : Less than 1min.</p> <p>Leave the capacitors in ambient condition for the following time before measurement.</p> <p>Class1 : 6~24h Class2 : <math>24 \pm 2</math>h</p>	Step	Temp. (°C)	Time(min.)	1	Min. operating Temp. $\pm 3$	$30 \pm 3$	2	Max. operating Temp. $\pm 2$	$30 \pm 2$
Step	Temp. (°C)	Time(min.)										
1	Min. operating Temp. $\pm 3$	$30 \pm 3$										
2	Max. operating Temp. $\pm 2$	$30 \pm 2$										
			<p>Solder the capacitors on a P.C. Board shown in Appendix1 before testing.</p> <p>Apply the rated voltage at temperature <math>85 \pm 2^\circ\text{C}</math> and 85%RH for 1,000 +48, 0h.</p> <p>Charge/discharge current shall not exceed 50mA.</p> <p>Leave the capacitors in ambient condition for the following time before measurement.</p> <p>Class1 : 6~24h Class2 : <math>24 \pm 2</math>h</p> <p>Voltage conditioning : (Only Class2) Voltage treat the capacitor under testing temperature and voltage for 1hour.</p> <p>Leave the capacitors in ambient condition for <math>24 \pm 2</math>h before measurement.</p> <p>Use this measurement for initial value.</p>									

(continued)

No.	Item	Performance	Test or inspection method													
16	Life															
	External appearance	No mechanical damage.	Solder the capacitors on a P.C. Board shown in Appendix1 before testing. Below the voltage shall be applied at maximum operating temperature $\pm 2^{\circ}\text{C}$ for 1,000 +48,0h.  <hr/> Applied voltage <hr/> Rated voltage x2 <hr/> Rated voltage x1.5 <hr/> Rated voltage x1.2 <hr/> Rated voltage x1 <hr/>													
	Capacitance	<table border="1"> <thead> <tr> <th colspan="2">Characteristics</th> <th>Change from the value before test</th> </tr> </thead> <tbody> <tr> <td>Class1</td> <td>COG</td> <td><math>\pm 3\%</math> or <math>\pm 0.3\text{pF}</math> whichever larger.</td> </tr> <tr> <td rowspan="3">*Class2</td> <td>X7R</td> <td><math>\pm 15\%</math></td> </tr> <tr> <td>X7S</td> <td><math>\pm 25\%</math></td> </tr> <tr> <td>X7T</td> <td></td> </tr> </tbody> </table> *Applied for some parts		Characteristics		Change from the value before test	Class1	COG	$\pm 3\%$ or $\pm 0.3\text{pF}$ whichever larger.	*Class2	X7R	$\pm 15\%$	X7S	$\pm 25\%$	X7T	
	Characteristics			Change from the value before test												
	Class1	COG		$\pm 3\%$ or $\pm 0.3\text{pF}$ whichever larger.												
*Class2	X7R	$\pm 15\%$														
	X7S	$\pm 25\%$														
	X7T															
Q Class1	<table border="1"> <thead> <tr> <th>Capacitance</th> <th>Q</th> </tr> </thead> <tbody> <tr> <td>30pF and over</td> <td>350 min.</td> </tr> <tr> <td>10pF and over under 30pF</td> <td><math>275+5/2 \times C</math> min.</td> </tr> <tr> <td>Under 10pF</td> <td><math>200+10 \times C</math> min.</td> </tr> </tbody> </table> C : Rated capacitance (pF)	Capacitance	Q	30pF and over	350 min.	10pF and over under 30pF	$275+5/2 \times C$ min.	Under 10pF	$200+10 \times C$ min.	For information which products has which applied voltage, please contact with our sales representative.  Charge/discharge current shall not exceed 50mA.  Leave the capacitors in ambient condition for the following time before measurement.  Class1 : 6~24h Class2 : $24 \pm 2\text{h}$						
Capacitance	Q															
30pF and over	350 min.															
10pF and over under 30pF	$275+5/2 \times C$ min.															
Under 10pF	$200+10 \times C$ min.															
D.F. Class2	200% of initial spec max.															
Insulation Resistance	1,000M $\Omega$ or 50 M $\Omega \cdot \mu\text{F}$ min. whichever smaller.		Voltage conditioning : (Only Class2) Voltage treat the capacitor under testing temperature and voltage for 1hour. Leave the capacitors in ambient condition for $24 \pm 2\text{h}$ before measurement. Use this measurement for initial value.													

\* As for the initial measurement of capacitors (Class2) on number 8, 10, 11, 13, and 14, leave capacitors at 150 -10, 0°C for 1h and measure the value after leaving capacitors for  $24 \pm 2\text{h}$  in ambient condition.

# Appendix 1

## P.C. board

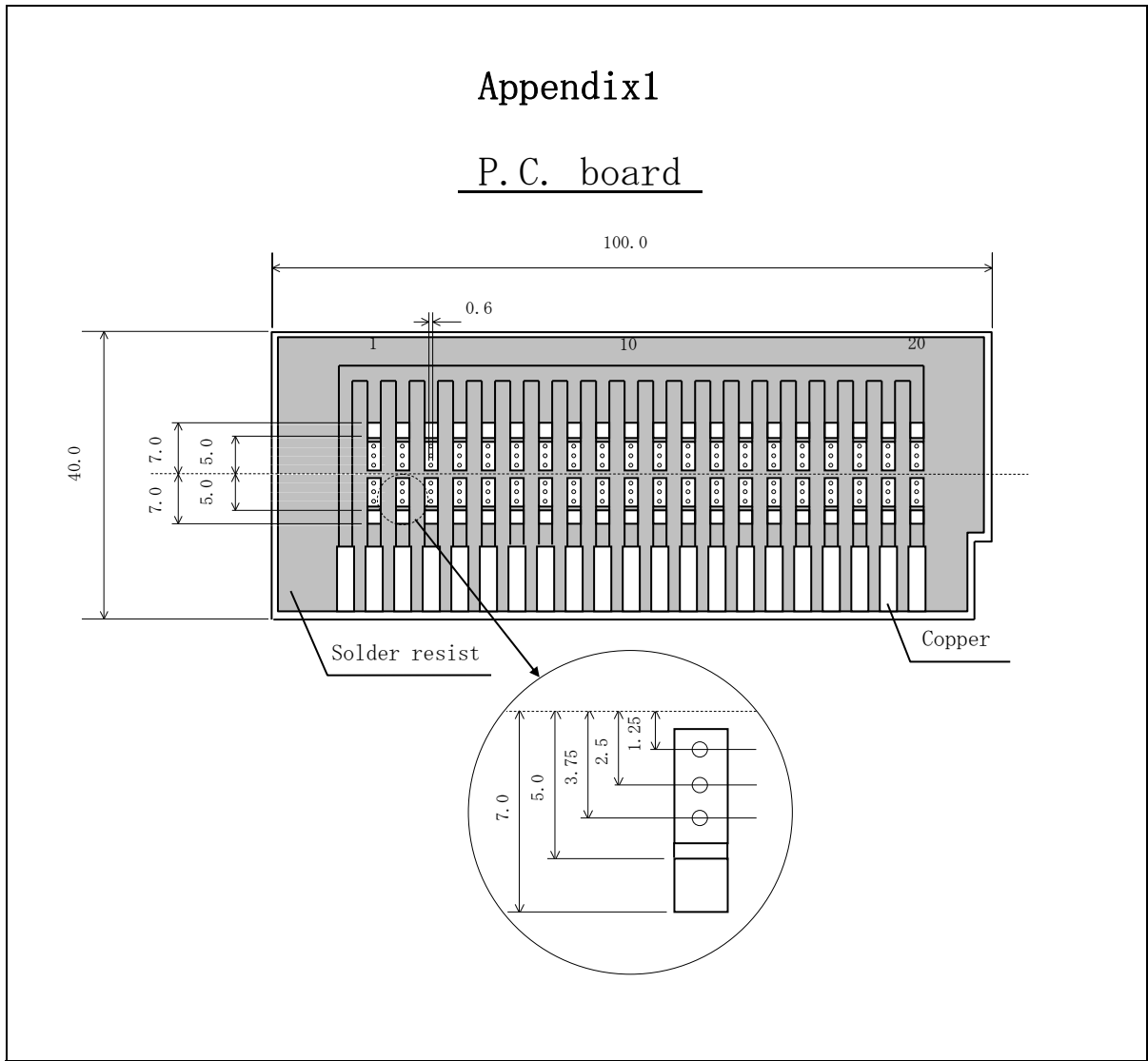

(Unit : mm)

1. Material :Glass Epoxy (As per JIS C6484 GE4)

2. Thickness : 1.6mm

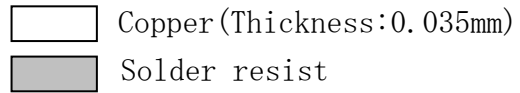

## 8. INDICATION

### 8.1 Indication (Example)

Type T.C.	FA 1 8 FA 2 8	FA 1 4 FA 2 4	FA 1 6 FA 2 6	FA 1 1 FA 2 0	FA 2 2	FA 2 3
C 0 G	(1) → 102		(1) → 104J ← (2) (3) ↗		(1) → 224J ← (2) (3) ↗ TDK ← (4)	
X 7 R X 7 S X 7 T	(1) → 104		(1) → 155K ← (2) (3) ↗		(1) → 335K ← (2) (3) ↗ TDK ← (4)	

### 8.2 Meaning of indication

No.	Detail	
(1)	Rated Capacitance	Indicate in three digits.
(2)	Capacitance tolerance	Indicates the symbol.
(3)	Rated voltage	For DC50V, indicate a bar under the rated capacitance.
(4)	Manufacturer	Indicates " TDK ".

## 9. INSIDE STRUCTURE AND MATERIAL

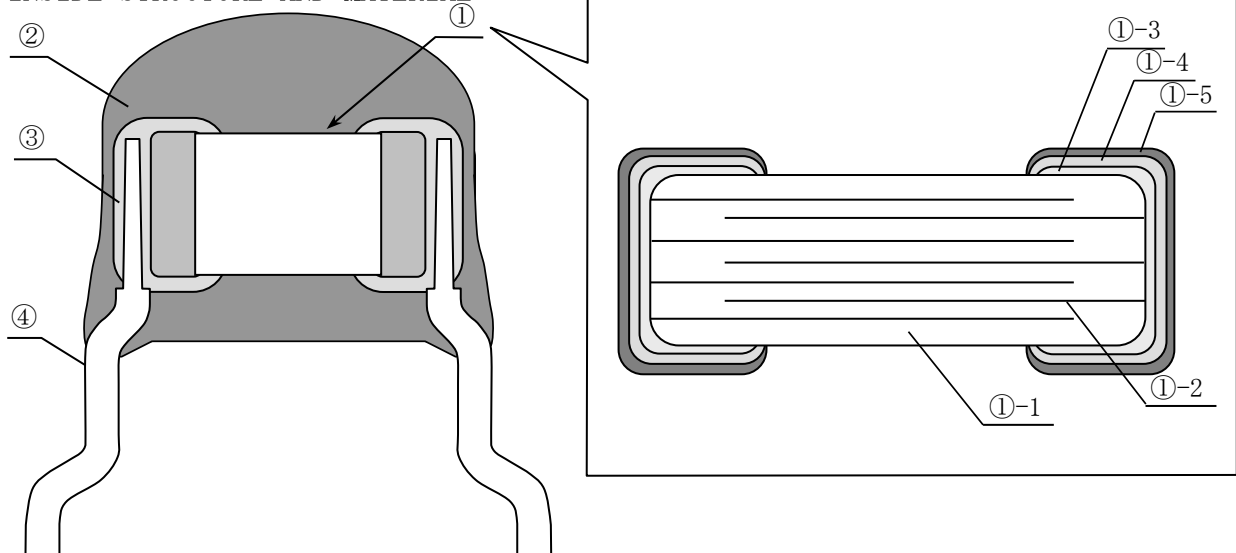

No.	NAME	No.	NAME	MATERIAL	
				Class 1	Class 2
①	Multilayer Ceramic Chip Capacitors	①-1	Dielectric	CaZrO <sub>3</sub>	BaTiO <sub>3</sub>
		①-2	Electrode	Ni	
		①-3	Termination	Cu	
		①-4		Ni	
		①-5		Sn	
②	Coating			Epoxy 【Halogen-free】	
③	Solder for joint			Lead Free solder	
④	Lead wire			Tin plated copper covers steel wire	

## 10. PACKAGING

Packaging shall be done to protect the components from the damage during Transportation and storing, and a label which has the following information shall be attached.

- 1) Inspection No. \*
- 2) TDK P/N
- 3) Quantity

\* Composition of Inspection No.

Example  $\frac{X}{(a)} \frac{8}{(b)} \frac{A}{(c)} - \frac{00}{(d)} - \frac{000}{(e)}$

- a) Inspection factory code
- b) Last digit of year
- c) Month and A for January and B for February and so on. (Skip I)
- d) Inspection Date of the month.
- e) Serial No. of the day

- 1) Total number of components in a plastic bag

Type	Qty. (pcs.)
FA18, FA28	500
FA14, FA24	
FA16, FA26	
FA11, FA20	
FA22	
FA23	200

- 2) Tape packaging is as per TDK tape packaging specification.

## 11. CAUTION

No.	Process	Condition
1	Operating Condition (Storage, Use, Transportation)	<p>1-1. Storage, Use</p> <ol style="list-style-type: none"> <li>1) The capacitor must be stored in an ambient temperature of 5~40°C with a relative humidity of 20~70%. The products should be used within 6 months upon receipt.</li> <li>2) The capacitors must be operated and stored in an environment free of dew condensation and these gases such as Hydrogen Sulphide, Hydrogen Sulphate, Chlorine, Ammonia and sulfur.</li> <li>3) Avoid storing in sun light and wet with dew.</li> <li>4) Do not use capacitors under high humidity and high and low atmospheric pressure which may affect capacitors reliability.</li> <li>5) Capacitors should be tested for the solderability when they are stored for long time.</li> </ol> <p>1-2. Handling in transportation</p> <ol style="list-style-type: none"> <li>1) In case of the transportation of the capacitors, the performance of the capacitors may be deteriorated depending on the transportation condition. (Refer to JEITA RCR-2335C 9.2 Handling in transportation)</li> </ol>
2	Circuit design  Caution	<p>2-1. Operating temperature</p> <p>Operating temperature should be followed strictly within this specification, especially be careful with the maximum temperature.</p> <ol style="list-style-type: none"> <li>1) Do not use capacitor above the maximum allowable operating temperature.</li> <li>2) Surface temperature including self heating should be below maximum operating temperature.              (Due to dielectric loss, capacitor will heat itself when AC is applied. Especially at high frequencies around its SRF, the heat might be so extreme that it may damage itself or the product mounted on. Please design the circuit so that the maximum temperature of the capacitor including the self heating to be below the maximum allowable operating temperature. Temperature rise shall be bellow 20°C.)</li> <li>3) The electrical characteristics of the capacitors will vary depending on the temperature. The capacitors should be selected and designed in taking the temperature into consideration.</li> </ol> <p>2-2. Operating voltage</p> <ol style="list-style-type: none"> <li>1) Operating voltage across the terminals should be below the rated voltage. When AC and DC are super imposed, V<sub>0-P</sub> must be below the rated voltage.              ——— (1) and (2)              AC or pulse with overshooting, V<sub>P-P</sub> must be below the rated voltage.              ——— (3), (4) and (5)</li> </ol> <p>When the voltage is started to apply to the circuit or it is stopped applying, the irregular voltage may be generated for a transit period because of resonance or switching. Be sure to use a capacitor within rated voltage containing these irregular voltage.</p>

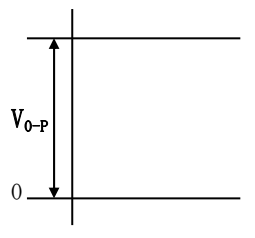
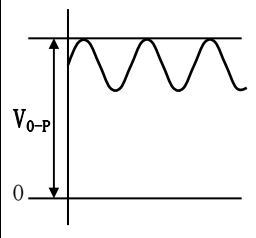
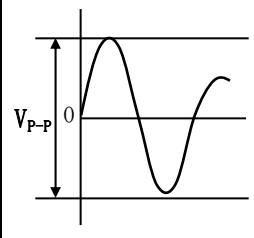
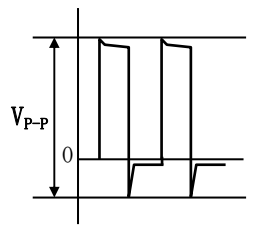
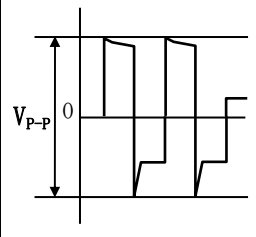
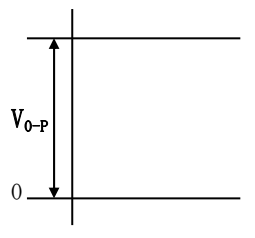
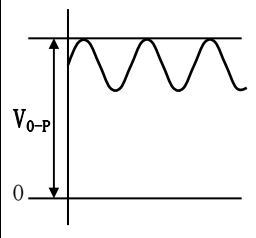
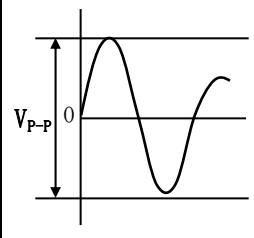
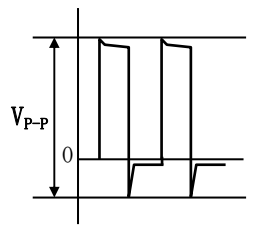
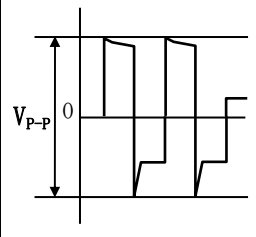
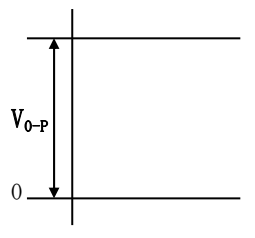
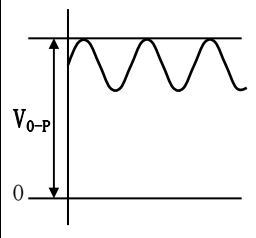
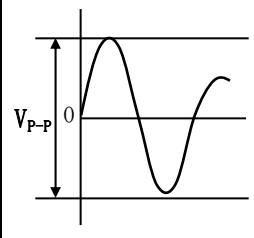
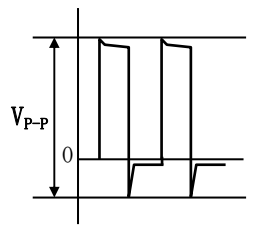
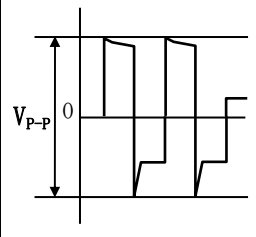
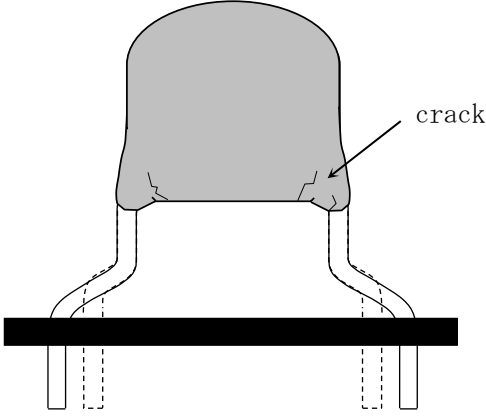
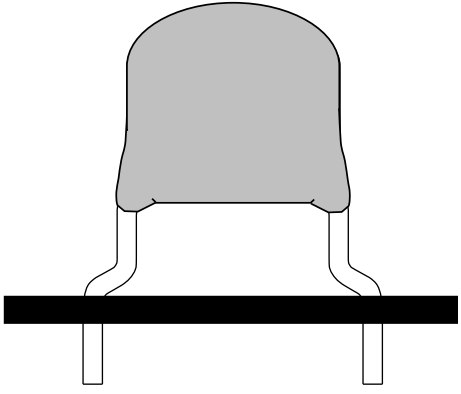
No.	Process	Condition																
2	Circuit design  Caution	<table border="1" style="width: 100%; border-collapse: collapse;"> <thead> <tr> <th style="width: 25%;">Voltage</th> <th style="width: 25%;">(1) DC voltage</th> <th style="width: 25%;">(2) DC+AC voltage</th> <th style="width: 25%;">(3) AC voltage</th> </tr> </thead> <tbody> <tr> <td style="text-align: center;">Positional Measurement (Rated voltage)</td> <td style="text-align: center;"></td> <td style="text-align: center;"></td> <td style="text-align: center;"></td> </tr> <tr> <th style="width: 25%;">Voltage</th> <th style="width: 25%;">(4) Pulse voltage (A)</th> <th style="width: 25%;">(5) Pulse voltage (B)</th> <th></th> </tr> <tr> <td style="text-align: center;">Positional Measurement (Rated voltage)</td> <td style="text-align: center;"></td> <td style="text-align: center;"></td> <td></td> </tr> </tbody> </table> <p data-bbox="443 857 1469 920">2) Even below the rated voltage, if repetitive high frequency AC or pulse is applied, the reliability of the capacitor may be reduced.</p> <p data-bbox="443 960 1469 1059">3) The effective capacitance will vary depending on applied DC and AC voltages. The capacitors should be selected and designed in taking the voltages into consideration.</p> <p data-bbox="411 1099 606 1128">2-3. Frequency</p> <p data-bbox="443 1133 1437 1196">1) When the capacitors (Class 2) are used in AC and/or pulse voltages, the capacitors may vibrate themselves and generate audible sound.</p>	Voltage	(1) DC voltage	(2) DC+AC voltage	(3) AC voltage	Positional Measurement (Rated voltage)				Voltage	(4) Pulse voltage (A)	(5) Pulse voltage (B)		Positional Measurement (Rated voltage)			
Voltage	(1) DC voltage	(2) DC+AC voltage	(3) AC voltage															
Positional Measurement (Rated voltage)																		
Voltage	(4) Pulse voltage (A)	(5) Pulse voltage (B)																
Positional Measurement (Rated voltage)																		
3	Designing P.C. board	<p data-bbox="411 1240 1469 1339">If capacitor leads are inserted into different pitch holes, it may induce excessive stress in the capacitor or outer resin to result in cracking, and it may degrade the quality.</p> <p data-bbox="411 1344 986 1373">Recommend capacitor layout is as following.</p> <div style="display: flex; justify-content: space-around; align-items: flex-end;"> <div style="text-align: center;"> <p data-bbox="614 1413 820 1442">Not recommended</p>  </div> <div style="text-align: center;"> <p data-bbox="1150 1413 1273 1442">Recommend</p>  </div> </div>																

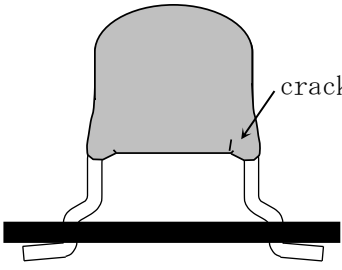
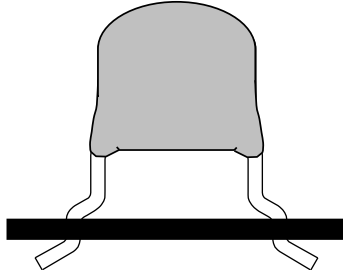
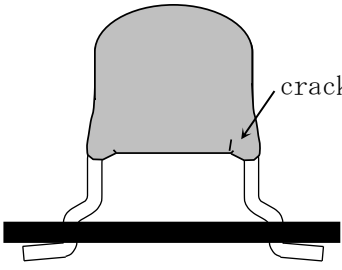
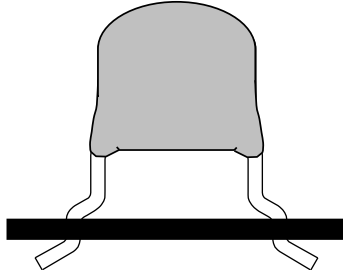
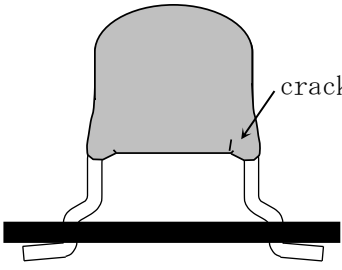
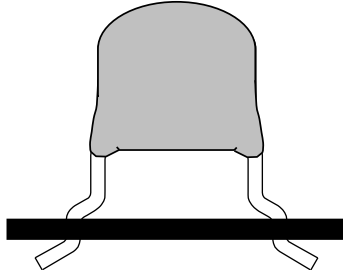
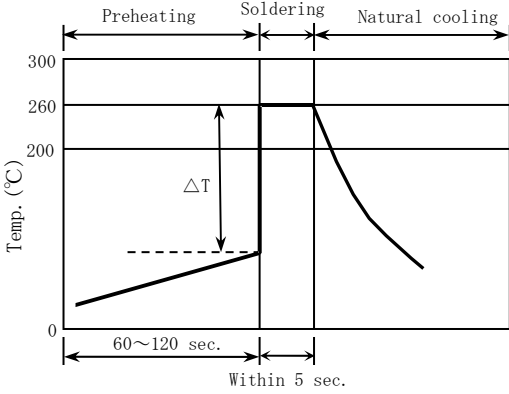
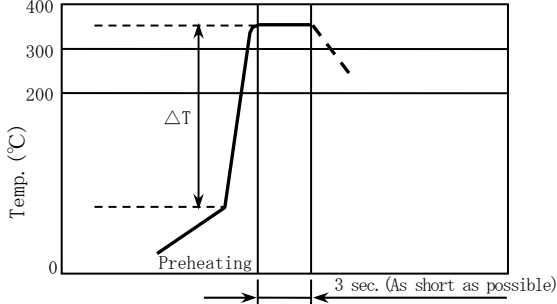
No.	Process	Condition						
4	Lead wire insertion	<p>1) If the leads clinching is too tight, the lead wire tend to be pulled excessively to cause lead wire breakage or cracking of the coating and quality degradation. Please adjust the clinching and provide sufficient preventive maintenance. Recommended capacitor layout is as following.</p> <table border="1" data-bbox="379 327 1353 651"> <thead> <tr> <th data-bbox="379 327 536 360"></th> <th data-bbox="536 327 943 360">Not recommended</th> <th data-bbox="943 327 1353 360">Recommended</th> </tr> </thead> <tbody> <tr> <td data-bbox="379 360 536 651">Clinching</td> <td data-bbox="536 360 943 651">  </td> <td data-bbox="943 360 1353 651">  </td> </tr> </tbody> </table> <p>2) If capacitor leads are inserted into different pitch holes, it may induce excessive stress in the capacitor or outer resin to result in cracking, and it may degrade the quality. When the lead pitch does not fit with the through hole on the pc board, please adjust the lead pitch so that the capacitor body would not receive excessive force.</p>		Not recommended	Recommended	Clinching		
	Not recommended	Recommended						
Clinching								
5	Soldering	<p>5-1. Flux selection Although highly-activated flux gives better solderability, substances which increase activity may also degrade the insulation of the capacitors. To avoid such degradation, it is recommended following.</p> <ol style="list-style-type: none"> <li>1) It is recommended to use a mildly activated rosin flux (less than 0.1wt% chlorine). Do not use acidic flux is not recommended.</li> <li>2) Excessive flux must be avoided. Please provide proper amount of flux.</li> <li>3) When water-soluble flux is used, enough washing is necessary.</li> </ol> <p>5-2. Recommended soldering profile by various methods</p> <div style="display: flex; justify-content: space-around;"> <div data-bbox="363 1317 874 1765"> <p style="text-align: center;">Flow soldering</p>  </div> <div data-bbox="898 1317 1457 1731"> <p style="text-align: center;">Manual soldering (Solder iron)</p>  </div> </div> <p>5-3. Avoiding thermal shock</p> <ol style="list-style-type: none"> <li>1) Preheating condition</li> </ol> <table border="1" data-bbox="536 1854 1086 1984"> <thead> <tr> <th data-bbox="536 1854 810 1899">Soldering</th> <th data-bbox="810 1854 1086 1899">Temp. (°C)</th> </tr> </thead> <tbody> <tr> <td data-bbox="536 1899 810 1944">Wave soldering</td> <td data-bbox="810 1899 1086 1944"><math>\Delta T \leq 150</math></td> </tr> <tr> <td data-bbox="536 1944 810 1984">Manual soldering</td> <td data-bbox="810 1944 1086 1984"><math>\Delta T \leq 190</math></td> </tr> </tbody> </table>	Soldering	Temp. (°C)	Wave soldering	$\Delta T \leq 150$	Manual soldering	$\Delta T \leq 190$
Soldering	Temp. (°C)							
Wave soldering	$\Delta T \leq 150$							
Manual soldering	$\Delta T \leq 190$							

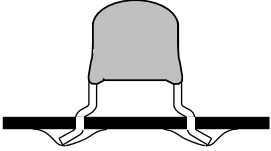
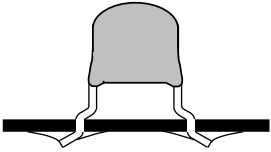

No.	Process	Condition								
5	Soldering	<p>2) Cooling condition Natural cooling using air is recommended. If the chips are dipped into a solvent for cleaning, the temperature difference(<math>\Delta T</math>) must be less than 100°C.</p> <p>5-4. Amount of solder In sufficient solder may detach the capacitor from the P.C.board. See below for example of solder amount.</p> <hr/> <div style="display: flex; justify-content: space-around; align-items: center;"> <div style="text-align: center;"> <p>Adequate</p>  </div> <div style="text-align: center;"> <p>Insufficient solder</p>  </div> <div style="text-align: left;"> <p>Low robustness may cause contact failure or capacitor comes off the P.C. board.</p> </div> </div> <hr/> <p>5-5. Solder repair by solder iron Tip temperature of solder iron varies by its type, P.C. board material and solder land size. Higher the tip temperature, quick the operation is, but the heat shock may crack the capacitor. Following condition is recommended.</p> <p style="text-align: center;">( Recommended solder iron condition )</p> <table border="1" style="margin-left: auto; margin-right: auto;"> <thead> <tr> <th data-bbox="472 954 699 987">Temp. (°C)</th> <th data-bbox="699 954 922 987">Wattage (W)</th> <th data-bbox="922 954 1145 987">Shape (mm)</th> <th data-bbox="1145 954 1369 987">Time (sec.)</th> </tr> </thead> <tbody> <tr> <td data-bbox="472 999 699 1032" style="text-align: center;">350 MAX.</td> <td data-bbox="699 999 922 1032" style="text-align: center;">20 MAX.</td> <td data-bbox="922 999 1145 1032" style="text-align: center;"><math>\phi</math> 3.0 MAX.</td> <td data-bbox="1145 999 1369 1032" style="text-align: center;">3 MAX.</td> </tr> </tbody> </table>	Temp. (°C)	Wattage (W)	Shape (mm)	Time (sec.)	350 MAX.	20 MAX.	$\phi$ 3.0 MAX.	3 MAX.
Temp. (°C)	Wattage (W)	Shape (mm)	Time (sec.)							
350 MAX.	20 MAX.	$\phi$ 3.0 MAX.	3 MAX.							
6	Cleaning	<p>1) If an unsuitable cleaning fluid is used, flux residue or some foreign articles may stick to capacitor surface to deteriorate especially the insulation resistance.</p> <p>2) If cleaning condition is not suitable, it may damage the capacitor.</p> <p>2)-1. Insufficient washing</p> <ol style="list-style-type: none"> <li>(1) Terminal electrodes may corrode by Halogen in the flux.</li> <li>(2) Halogen in the flux may adhere on the surface of capacitor, and lower the insulation resistance.</li> <li>(3) Water soluble flux has higher tendency to have above mentioned problems (1) and (2).</li> </ol> <p>2)-2. Excessive washing</p> <ol style="list-style-type: none"> <li>(1) Excessive washing may damage the coating material of coated capacitor and deteriorate it.</li> <li>(2) When ultrasonic cleaning is used, excessively high ultrasonic energy output can affect the adhesion between the ceramic dielectric and the terminal electrodes. To avoid this, following is the recommended condition. <p style="margin-left: 40px;">Power : 20W/ℓ max. Frequency : 40kHz max. Washing time : 5 minutes max.</p> </li> </ol> <p>2)-3. If the cleaning fluid is contaminated, density of Halogen increases, and it may bring the same result as insufficient cleaning.</p>								

No.	Process	Condition
7	Coating and molding of the P. C. board	<p>1) When the P. C. board is coated, please verify the quality influence on the product.</p> <p>2) Please verify carefully that there is no harmful decomposing or reaction gas emission during curing which may damage the capacitor.</p> <p>3) Please verify the curing temperature.</p>
8	Lead wire bending	<p>During lead wire bending process, mechanical stress often concentrates in one part of capacitor body and it may damage the ceramic and the coating. Refer to following for bending the lead wire.</p> <div data-bbox="758 616 1173 1041" data-label="Image"> </div> <p>When bending the lead wire, hold the wire closer to the capacitor with a fixture so that the lead bending would not affect the capacitor body.</p>
9	Handling of loose capacitor	<p>If dropped the capacitor may crack. Once dropped do not use it. Especially, the large case sized capacitor is tendency to have cracks easily, so please handle with care.</p> <div data-bbox="710 1299 1236 1780" data-label="Image"> </div>
10	Capacitance aging	<p>The capacitors (Class 2) have aging in the capacitance. They may not be used in precision time constant circuit. In case of the time constant circuit, the evaluation should be done well.</p>

No.	Process	Condition
11	Estimated life and estimated failure rate of capacitors	<p>The estimated life and the estimated failure rate depend on the temperature and the voltage. This can be calculated by the equation described in JEITA RCR-2335C Annex F (Informative) Calculation of the estimated lifetime and the estimated failure rate (Temperature acceleration : 3rd powered law, Voltage acceleration : 10degC law)</p> <p>The failure rate can be decreased by reducing the temperature and the voltage but they will not be guaranteed.</p>
12	Caution during operation of equipment	<ol style="list-style-type: none"> <li>1) A capacitor shall not be touched directly with bare hands during operation in order to avoid electric shock. Electric energy held by the capacitor may be discharged through the human body when touched with a bare hand. Even when the equipment is off, a capacitor may stay charged. The capacitor should be handled after being completely discharged using a resistor.</li> <li>2) The terminals of a capacitor shall not be short-circuited by any accidental contact with a conductive object. A capacitor shall not be exposed to a conductive liquid such as an acid or alkali solution. A conductive object or liquid, such as acid and alkali, between the terminals may lead to the breakdown of a capacitor due to short circuit</li> <li>3) Confirm that the environment to which the equipment will be exposed during transportation and operation meets the specified conditions. Do not to use the equipment in the following environments. <ol style="list-style-type: none"> <li>(1) Environment where a capacitor is splattered with water or oil</li> <li>(2) Environment where a capacitor is exposed to direct sunlight</li> <li>(3) Environment where a capacitor is exposed to Ozone, ultraviolet rays or radiation</li> <li>(4) Environment where a capacitor exposed to corrosive gas (e.g. hydrogen sulfide, sulfur dioxide, chlorine, ammonia gas etc.)</li> <li>(5) Environment where a capacitor exposed to vibration or mechanical shock exceeding the specified limits.</li> <li>(6) Atmosphere change with causes condensation</li> </ol> </li> </ol>

No.	Process	Condition
13	Others  Caution	<p>The product listed in this specification is intended for use in automotive applications under-normal operation and usage conditions.</p> <p>The product is not designed or warranted to meet the requirements of the applications listed below, whose performance and/or quality requires a more stringent level of safety or reliability, or whose failure, malfunction or defect could cause serious damage to society, person or property. Please understand that we are not responsible for any damage or liability caused by use of the products in any of the applications below or for any other use exceeding the range or conditions set forth in this specification sheet. If you intend to use the products in the applications listed below or if you have special requirements exceeding the range or conditions set forth in this specification, please contact us.</p> <ul style="list-style-type: none"> <li>(1) Aerospace/Aviation equipment</li> <li>(2) Transportation equipment (electric trains, ships etc.)</li> <li>(3) Medical equipment (Excepting Pharmaceutical Affairs Law classification Class1,2)</li> <li>(4) Power-generation control equipment</li> <li>(5) Atomic energy-related equipment</li> <li>(6) Seabed equipment</li> <li>(7) Transportation control equipment</li> <li>(8) Public information-processing equipment</li> <li>(9) Military equipment</li> <li>(10) Electric heating apparatus, burning equipment</li> <li>(11) Disaster prevention/crime prevention equipment</li> <li>(12) Safety equipment</li> <li>(13) Other applications that are not considered general-purpose applications</li> </ul> <p>When designing your equipment even for general-purpose applications, you are kindly requested to take into consideration securing protection circuit/device or providing backup circuits in your equipment.</p> <p>In addition, although the product listed in this specification is intended for use in automotive applications as described above, it is not prohibited to use in general electronic equipment, whose performance and/or quality doesn't require a more stringent level of safety or reliability, or whose failure, malfunction or defect could not cause serious damage to society, person or property.</p> <p>Therefore, the description of this caution will be applied, when the products are used in general electronic equipment under a normal operation and usage conditions.</p>

## 12. TAPE PACKAGING SPECIFICATION

### 1. CONSTRUCTION AND DIMENSION OF TAPING

Dimensions of FA1\* type shall be according to Appendix 2.

Dimensions of FA2\* type shall be according to Appendix 3.

### 2. QUANTITY

Type	Parts quantity/box (pcs.)
FA18, FA28 FA14, FA24 FA16, FA26	2,000
FA11, FA20	1,500
FA22 FA23	1,000

※ In case of FA22 and FA23 series, a stainless round steel is put in a hole of tape.

### 3. PERFORMANCE SPECIFICATIONS

3-1. The missing of components shall be within consecutive 3pcs.

3-2. Empty part for min 3pcs shall be provided at the beginning and the end of taping.

3-3. Shipping label must be attached at the side of carton.

3-4. When pull the carrier tape for left side with keeping the head of capacitors to the direction of the above figure, adhesive tape shall be upper side.

3-5. Folded tape shall contain 25pcs. of components.

# Appendix 2

## Taping dimensions (FA18, FA14, FA16, FA11)

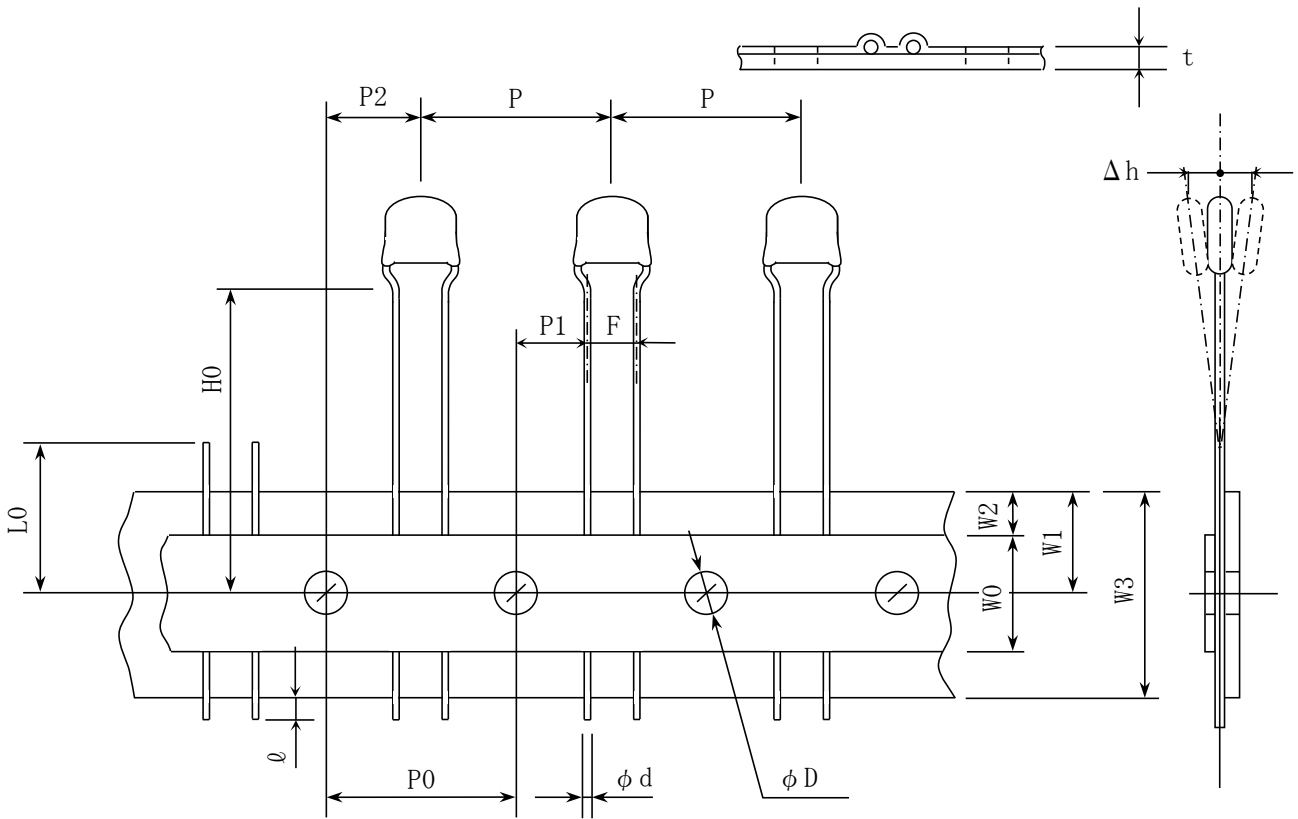

(Unit : mm)

Symbol	Dimensions	Tolerance
P	12.7	±1.0
P0 ※1	12.7	±0.3
P1	5.1	±0.7
P2	6.35	±1.3
W0	12.0	±1.0
W1	9.0	±0.5
W2 ※2	3.0	3.0 and under
W3	18.0	+1.0, -0.5
H0	16.0	±0.5
ℓ	1.0	1.0 and under
t	0.6	±0.2
L0	11.0	11.0 and under
F	2.5	+0.5, -0.2
φ d	φ 0.5	+0.1, -0.03
φ D	φ 4.0	±0.2
Δh	—	±2

※1 Accumulated pitch tolerance shall be ±2mm for 20 pitches.

※2 Adhesive tape shall not stick out from carrier tape.

# Appendix 3

# Taping dimensions

(FA28, FA24, FA26, FA20, FA22, FA23)

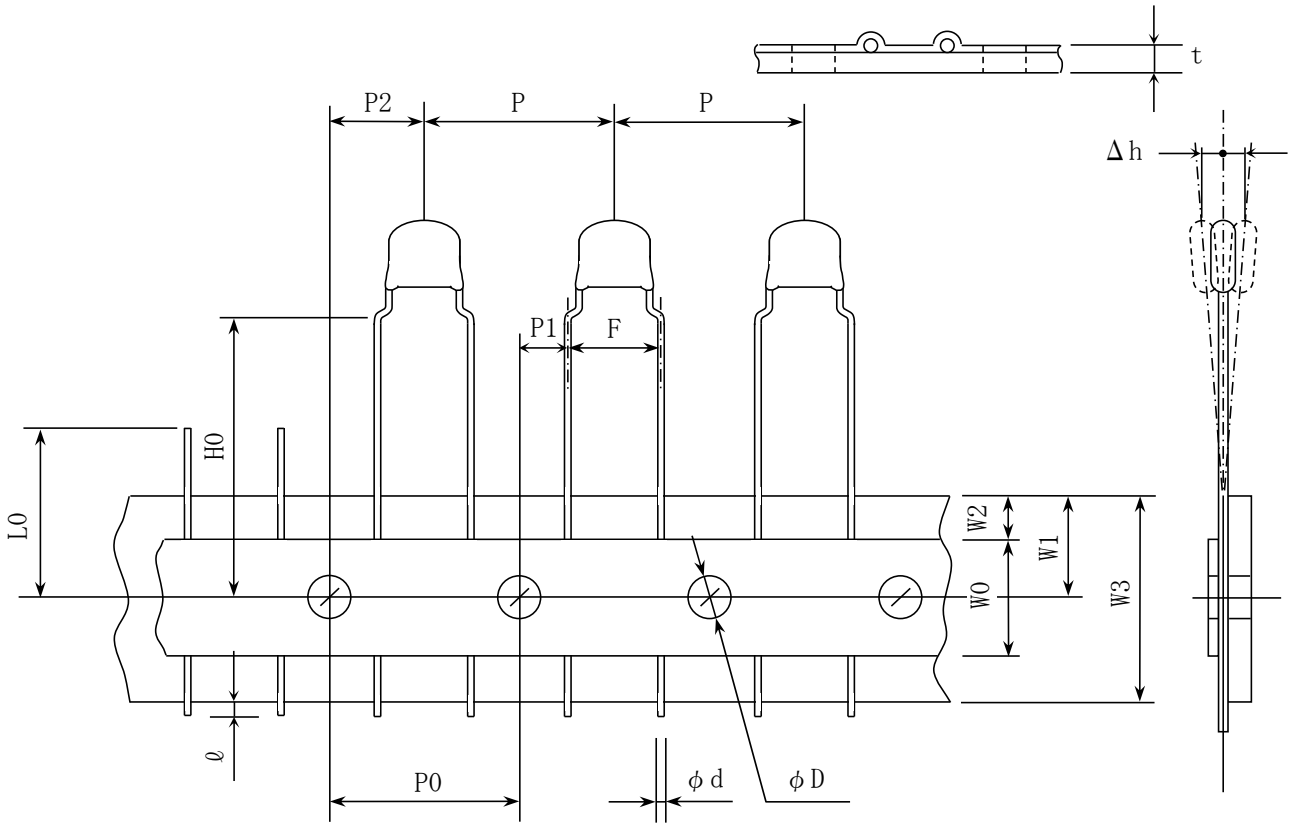

(Unit : mm)

Symbol	Dimensions	Tolerance
P	12.7	$\pm 1.0$
P0 ※1	12.7	$\pm 0.3$
P1	3.85	$\pm 0.7$
P2	6.35	$\pm 1.3$
W0	12.0	$\pm 1.0$
W1	9.0	$\pm 0.5$
W2 ※2	3.0	3.0 and under
W3	18.0	+1.0, -0.5
H0	16.0	$\pm 0.5$
$\ell$	1.0	1.0 and under
t	0.6	$\pm 0.2$
L0	11.0	11.0 and under
F	5.0	+0.8, -0.2
$\phi d$	$\phi 0.5$	+0.1, -0.03
$\phi D$	$\phi 4.0$	$\pm 0.2$
$\Delta h$	—	$\pm 2$

※1 Accumulated pitch tolerance shall be  $\pm 2$ mm for 20 pitches.

※2 Adhesive tape shall not stick out from carrier tape.