

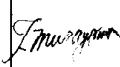



# DLP75-24-1

## EVALUATION DATA

DWG.No CA733-53-01			
QA APPD	APPD	CHK	DWG
 Sun/03	 25.103	 30/May/03	 20/May/03

## INDEX

	PAGE
1. Evaluation Method	
1.1 Circuit used for determination .....	T-1~4
(1) Steady state data	
(2) Warm up voltage drift characteristics	
(3) Over current protection (OCP) characteristics	
(4) Over voltage protection (OVP) characteristics	
(5) Output rise characteristics	
(6) Output fall characteristics	
(7) Dynamic line response characteristics	
(8) Input voltage dip test	
(9) Dynamic load response characteristics	
(10) Inrush current characteristics	
(11) Leakage current characteristics	
(12) Output ripple and noise waveform	
(13) Stand-by current	
(14) Electro Magnetic Interference characteristics	
1.2 List of equipment used .....	T-5
2. Characteristics	
2.1 Steady state data	
(1) Regulation - line and load, temperature drift .....	T-6
(2) Output voltage and ripple voltage vs. input voltage .....	T-6
(3) Efficiency and input current vs. output current .....	T-7
(4) Power factor and input current vs. output current .....	T-8
2.2 Warm up voltage drift characteristics .....	T-9
2.3 Over current protection (OCP) characteristics .....	T-10~11
2.4 Over voltage protection (OVP) characteristics .....	T-12
2.5 Output rise characteristics .....	T-13~14
2.6 Output fall characteristics .....	T-15~16

2.7 Dynamic line response characteristics .....	T-17
2.8 Input voltage dip test .....	T-18
2.9 Dynamic load response characteristics .....	T-19
2.10 Response to brown out characteristics .....	T-20
2.11 Inrush current waveform .....	T-21~22
2.12 Input current waveform .....	T-23
2.13 Input current harmonics .....	T-24
2.14 Leakage current characteristics .....	T-25
2.15 Output ripple and noise waveform .....	T-26
2.16 Stand-by current .....	T-27
2.17 Hold up time characteristics .....	T-28
2.18 Electro Magnetic Interference characteristics .....	T-29~32

Terminology used

	Definition
$V_{in}$ .....	Input voltage
$V_{out}$ .....	Output voltage
$I_{in}$ .....	Input current
$I_{out}$ .....	Output current
$f$ .....	Frequency
$T_a$ .....	Ambient temperature

1.1 Circuit used for determination

**(1) Measurement Circuit. 1**

- Steady state data
- Warm up voltage drift characteristics
- Over voltage protection (OVP) characteristics
- Output rise characteristics
- Output fall characteristics
- Dynamic line response characteristics
- Stand by current characteristics

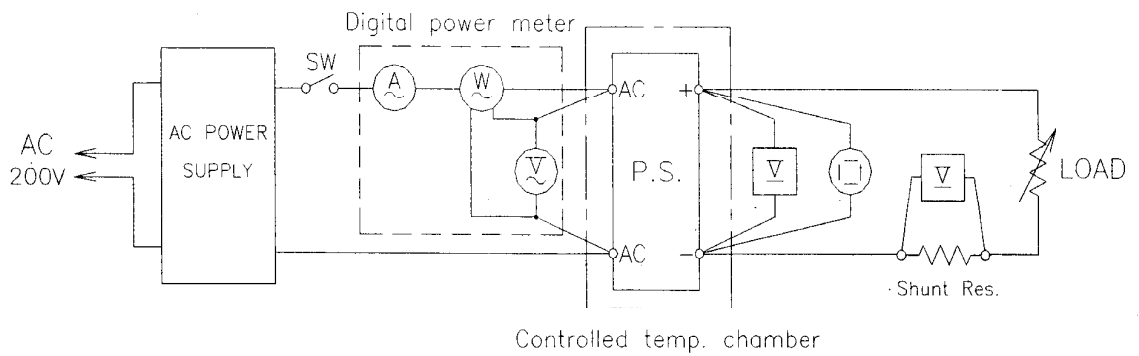

**(2) Measurement Circuit. 2**

- Over current protection (OCP) characteristics

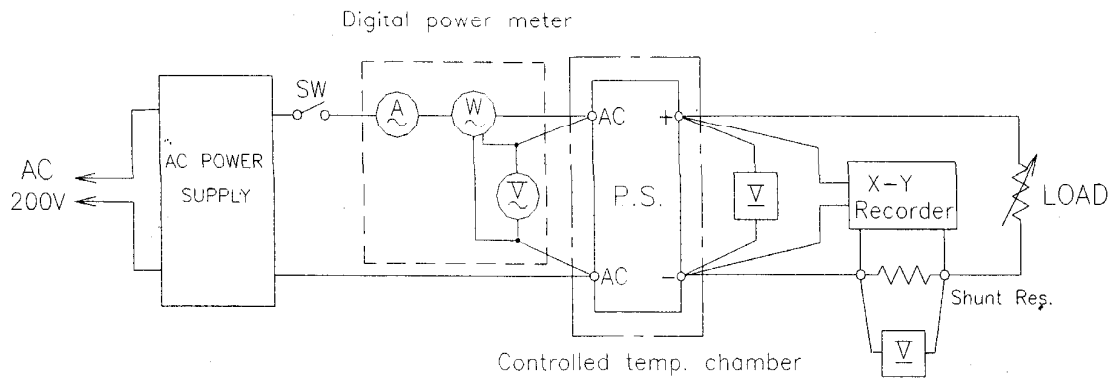

**Measurement circuit. 3**

• Dynamic load response characteristics

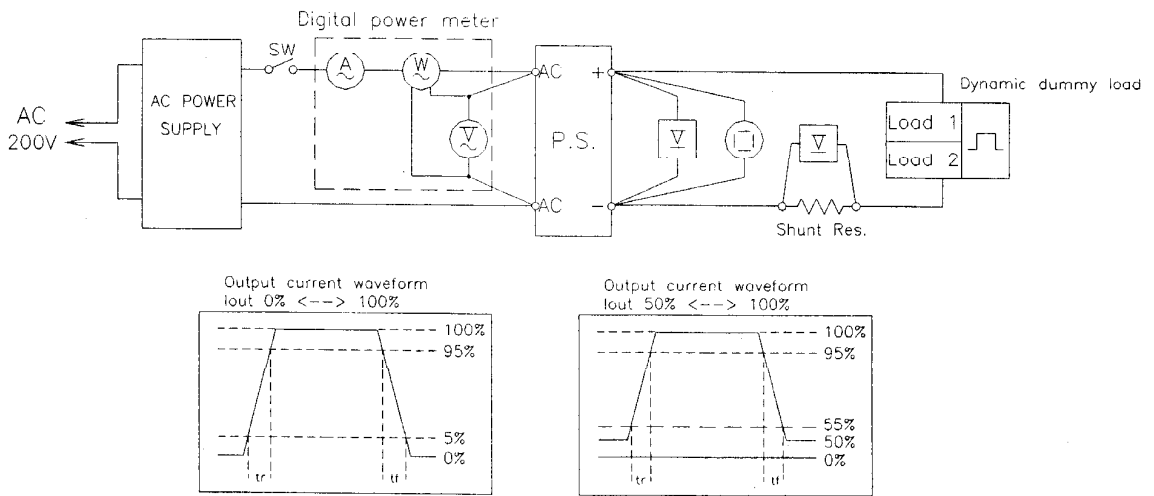

**Measurement circuit. 4**

• Inrush current characteristics

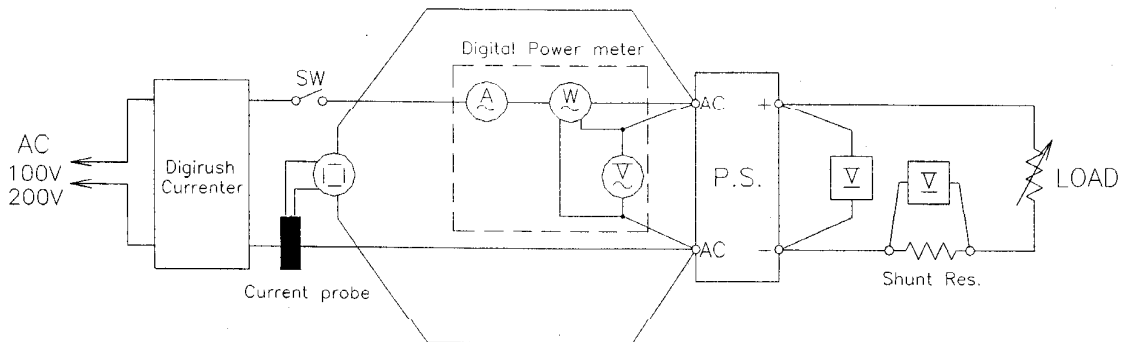

**Measurement circuit. 5**

• Leakage current characteristics

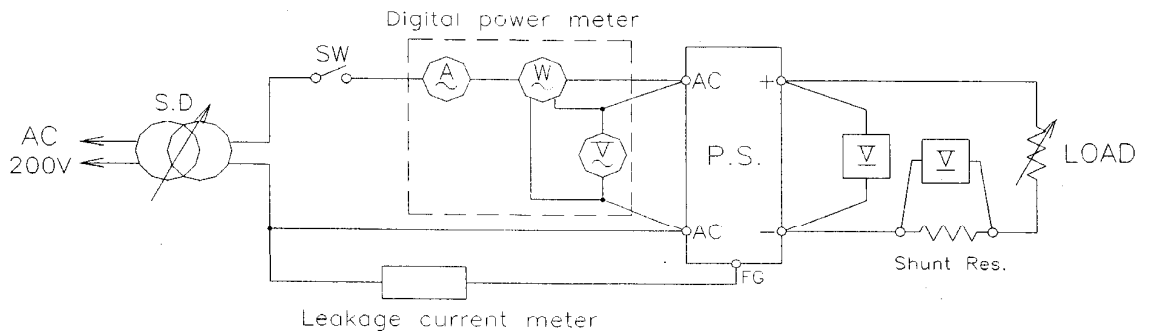

NOTE : Leakage current measured through a 1k ohm resistor.

Range used --- AC+DC (For YOKOGAWA : TYPE3226)

AC (For SIMPSON : MODEL 229-2)

**Measurement circuit. 6**

- Output ripple and noise
- (a) Normal Mode (JEITA Standard RC-9131)

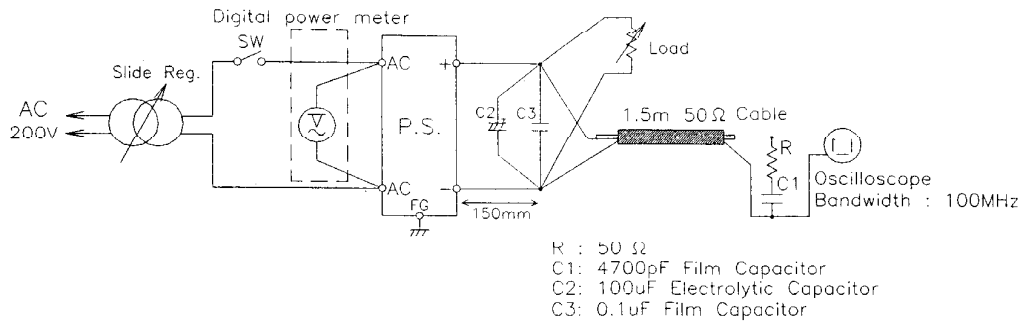

**Measurement circuit. 7**

- Output ripple and noise
- (b) Normal + Common Mode

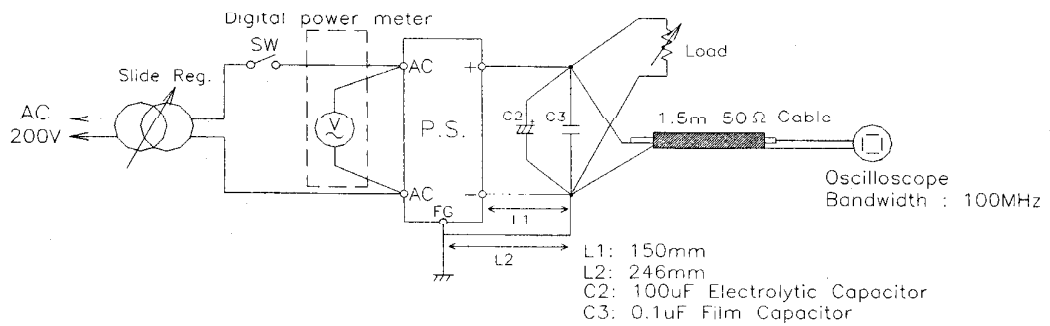

**Measurement circuit. 8**

- Electro-Magnetic Interference characteristics
- (a) Conducted Emission Noise

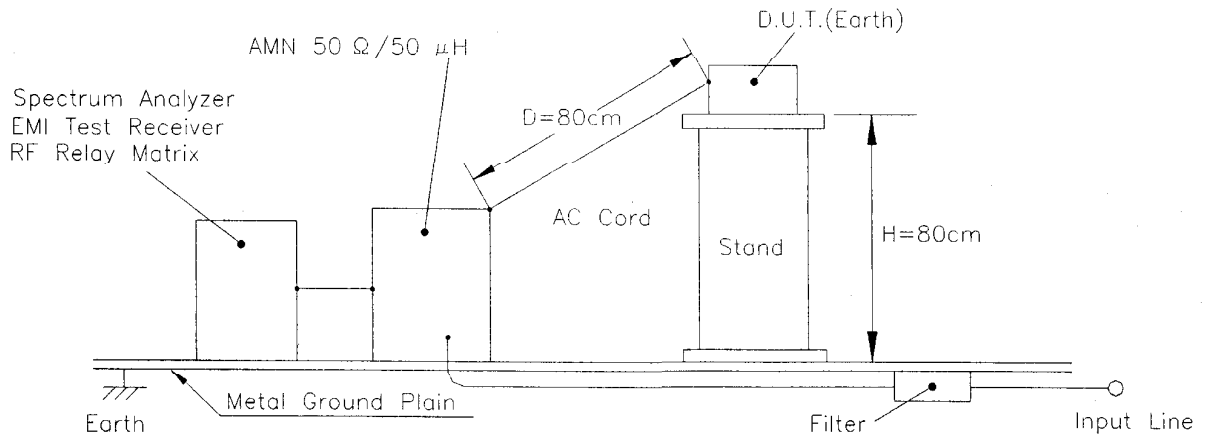

**Measurement circuit. 9**

- Electro-Magnetic Interference characteristics
- (b) Radiated Emission Noise

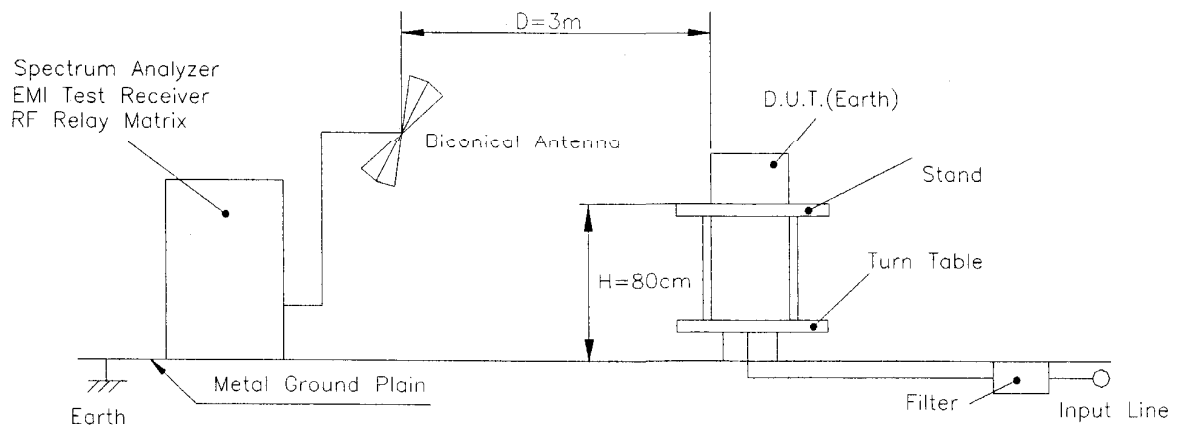

## 1.2 LIST OF EQUIPMENT USED

	EQUIPMENT USED	MANUFACTURER	MODEL NO.
1	OSCILLOSCOPE	HITACHI	V-1100A
2	DIGITAL STORAGE OSCILLOSCOPE	TEKTRONIX	TDS754C
3	DIGITAL MULTIMETER	ADVANTEST	R6551
4	DIGITAL POWER METER	YOKOGAWA ELECT.	WT110E
5	SHUNT RESISTOR	YOKOGAWA ELECT.	2215
6	DYNAMIC DUMMY LOAD	TAKASAGO	FK-200L
7	CURRENT PROBE/AMPLIFIER	TEKTRONIX	A6303/AM503
8	CONTROLLED TEMP. CHAMBER	TABAI-ESPEC	SH-240SI
9	AC POWER SUPPLY	TAKASAGO	AA2000XG
10	LEAKAGE CURRENT METER	SIMPSON	MODEL229-2
11	LEAKAGE CURRENT METER	YOKOGAWA ELECT.	TYPE3226
12	X-Y RECORDER	GRAPHTEC	WX3000
13	SPECTRUM ANALYZER	ROHDE & SCHWARZ	FSA
14	EMI TEST RECEIVER	ROHDE & SCHWARZ	ESHS10
15	EMI TEST RECEIVER	ROHDE & SCHWARZ	FSVS10
16	RF RELAY MATRIX	ROHDE & SCHWARZ	PSU
17	AMN	KYORITU DENSHI	KNW-242
18	ANTENNA(BICONICAL ANTENA)	SCHWARZBECK	BBA9106



2. Characteristics

2.1 Steady state data

(1) Regulation - line and load, temperature drift

24V

1. Regulation-line and load

Iout \ Vin	85VAC	100VAC	230VAC	265VAC	line regulation	
0%	24.059V	24.074V	24.065V	24.071V	0.015V	0.063%
50%	24.050V	24.049V	24.057V	24.057V	0.008V	0.033%
100%	24.033V	24.033V	24.041V	24.040V	0.008V	0.033%
load	0.026V	0.041V	0.024V	0.031V		
regulation	0.108%	0.171%	0.100%	0.129%		

2. Temperature drift

Conditions; Vin = 100VAC  
Iout = 100%

Ta	-10°C	+25°C	+50°C	Temperature stability	
Vout	24.042V	24.033V	24.020V	0.022V	0.09%

(2) Output voltage and Ripple voltage v.s. Input voltage

Conditions; Iout : 100%

Ta : -10°C -----  
: 25°C -----  
: 50°C -----

24V

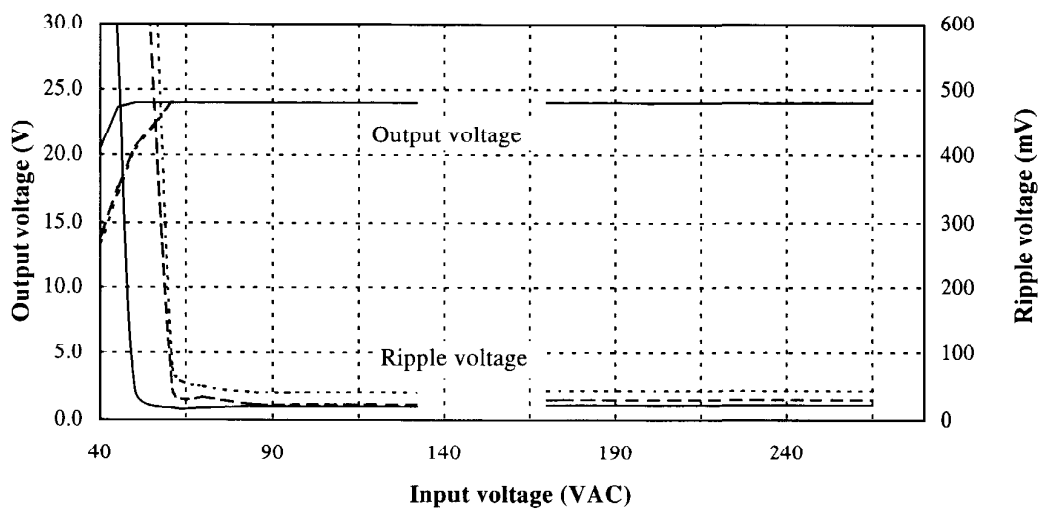

2.1 (3) Efficiency and input current v.s. Output current

Conditions;  $V_{in}$  : 85VAC -----  
 : 100VAC -----  
 : 132VAC -----  
 $T_a$  : 25°C

24V

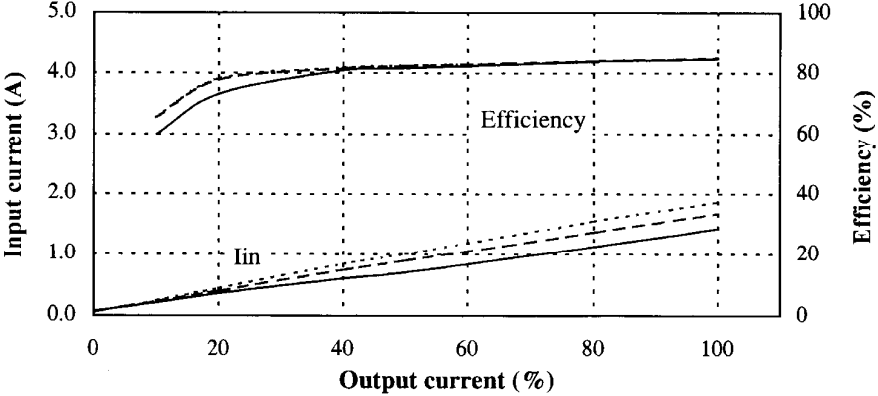

Conditions;  $V_{in}$  : 170VAC -----  
 : 230VAC -----  
 : 265VAC -----  
 $T_a$  : 25°C

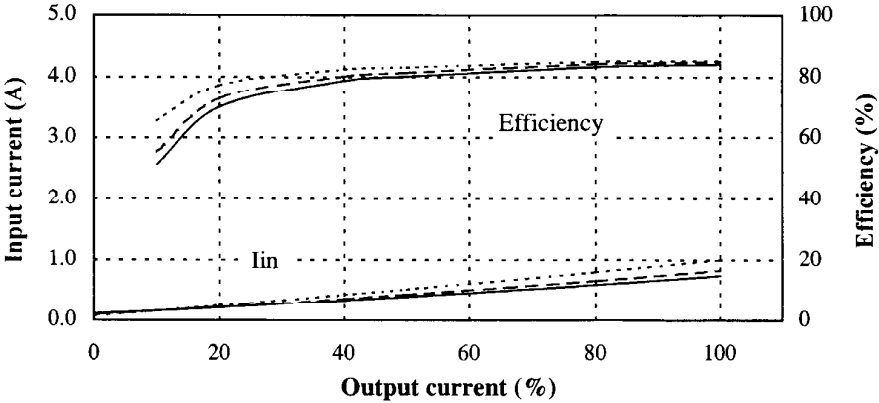

2.1 (4) Power factor and Input current v.s Output current

Conditions; Vin : 85VAC -----  
 : 100VAC -----  
 : 132VAC -----  
 Ta : 25°C

24V

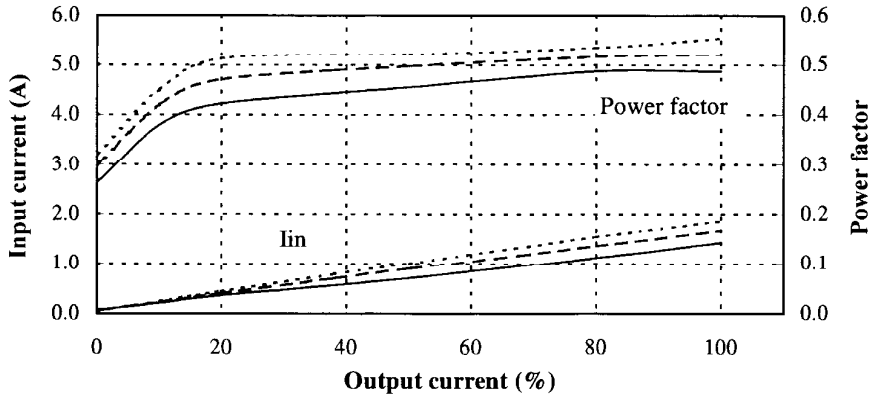

Conditions; Vin : 170VAC -----  
 : 230VAC -----  
 : 265VAC -----  
 Ta : 25°C

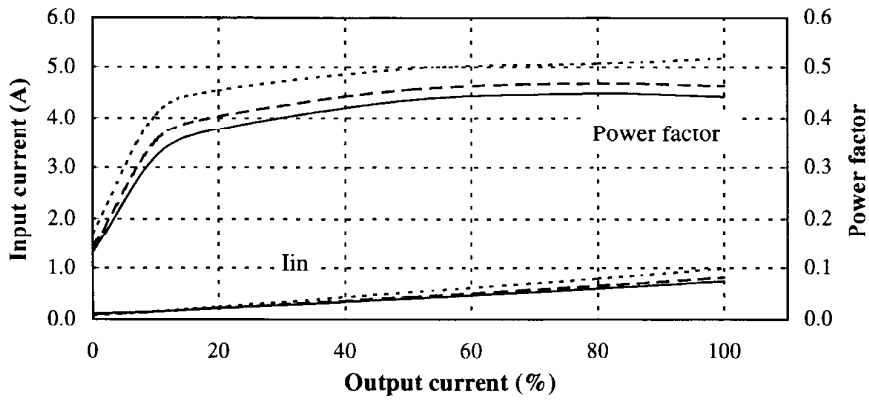

2.2 Warm up voltage drift characteristics

Conditions; Vin : 100VAC  
Iout : 100%  
Ta : 25°C

24V

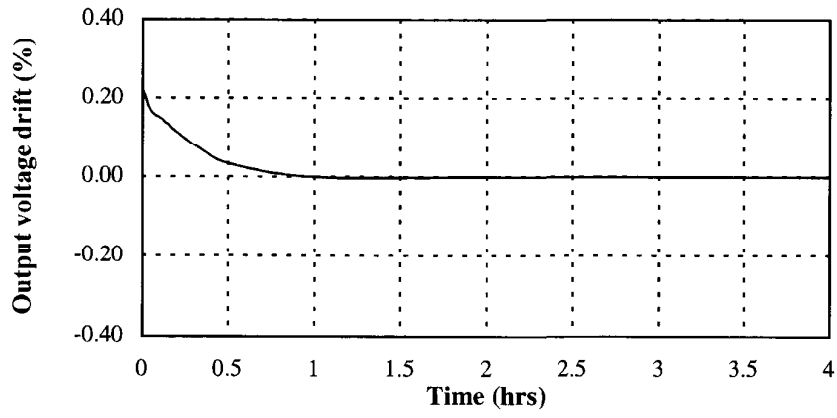

2.3 Over current protection (OCP) characteristics

Conditions; Ta : -10°C ———  
 : 25°C - - - - -  
 : 50°C ———  
 Vin : 100VAC

24V

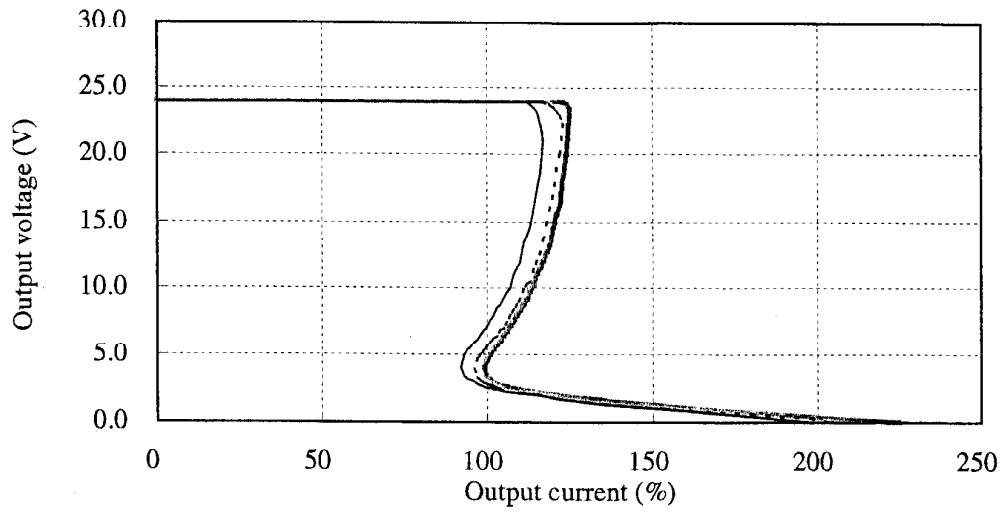

Conditions; Ta : -10°C ———  
 : 25°C - - - - -  
 : 50°C ———  
 Vin : 230VAC

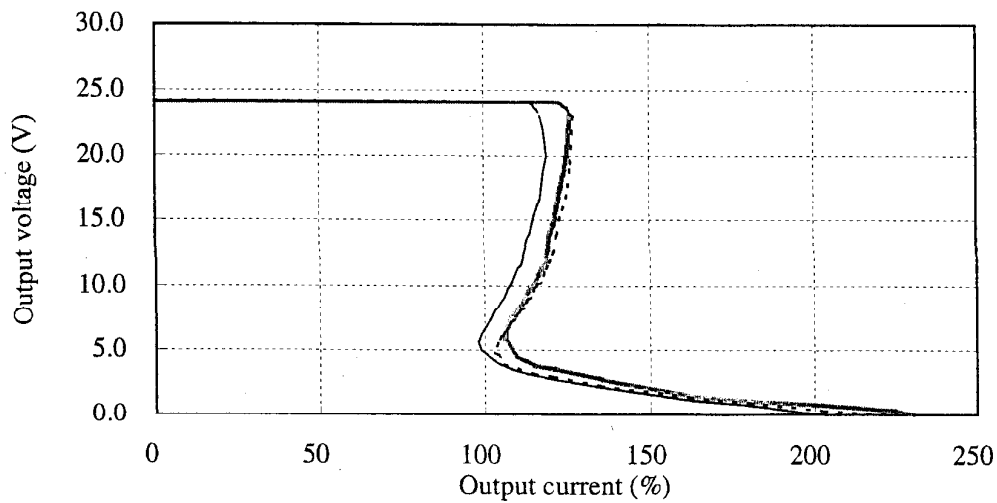

2.3 Over current protection (OCP) characteristics

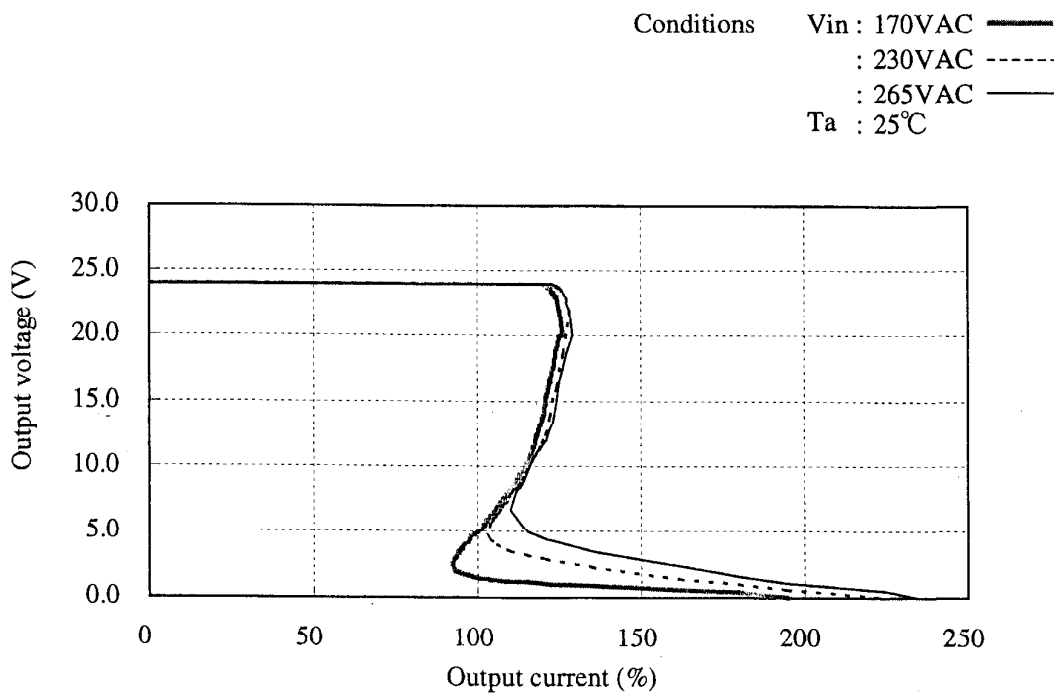
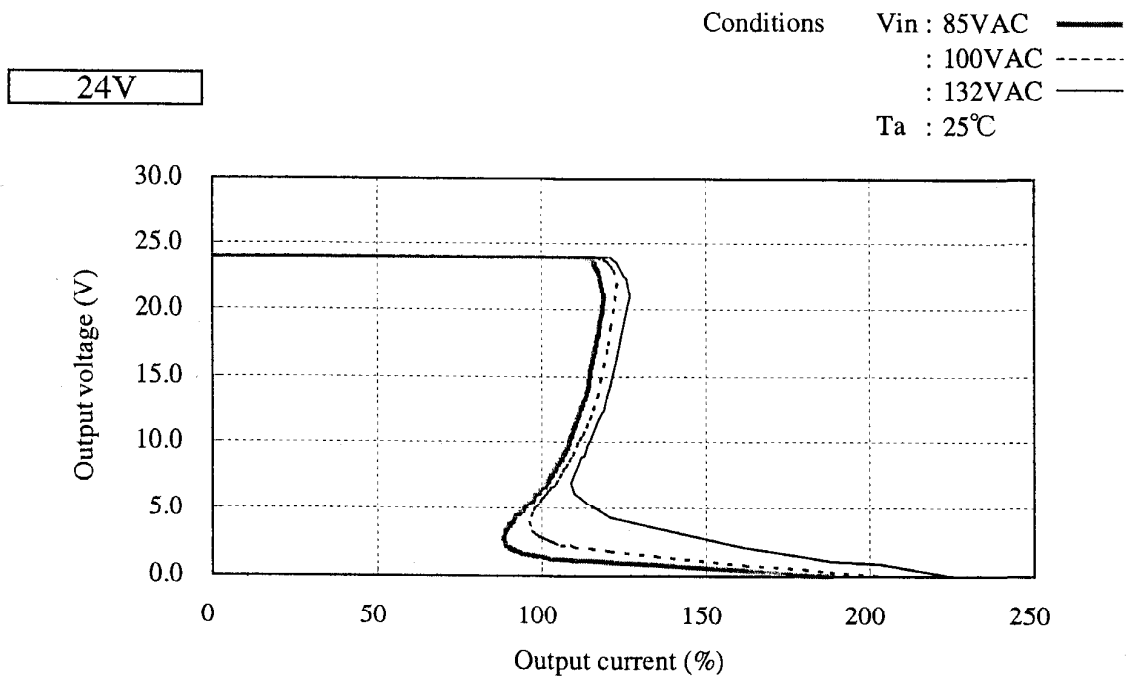

2.4 Over voltage protection (OVP) characteristics

Conditions; Vin : 100VAC  
Iout : 0%  
Ta : 25°C

24V

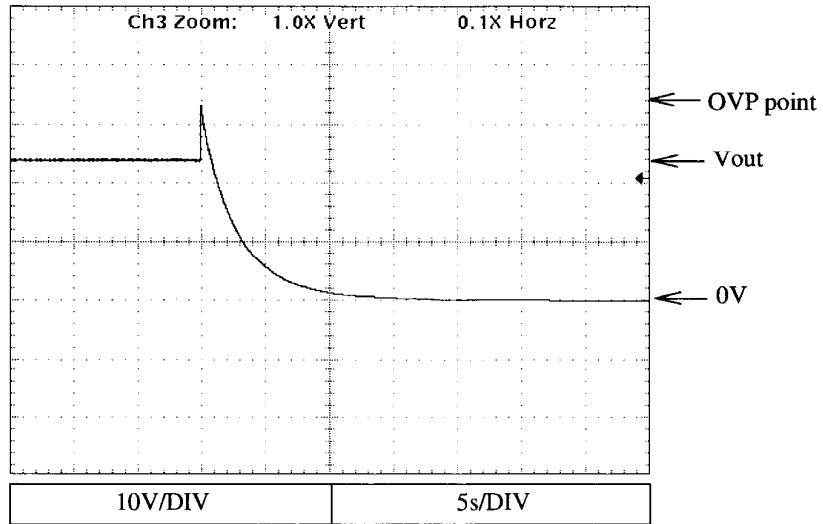

2.5 Output rise characteristics

Conditions Vin : 85VAC (A)  
 : 100VAC (B)  
 : 132VAC (C)  
 Iout : 0%  
 Ta : 25°C

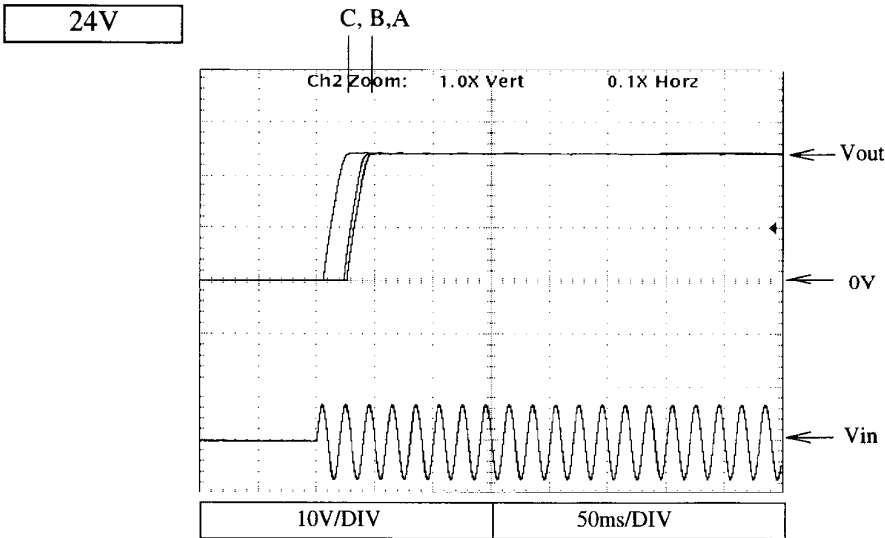

Conditions Vin : 170VAC (D)  
 : 230VAC (E)  
 : 265VAC (F)  
 Iout : 0%  
 Ta : 25°C

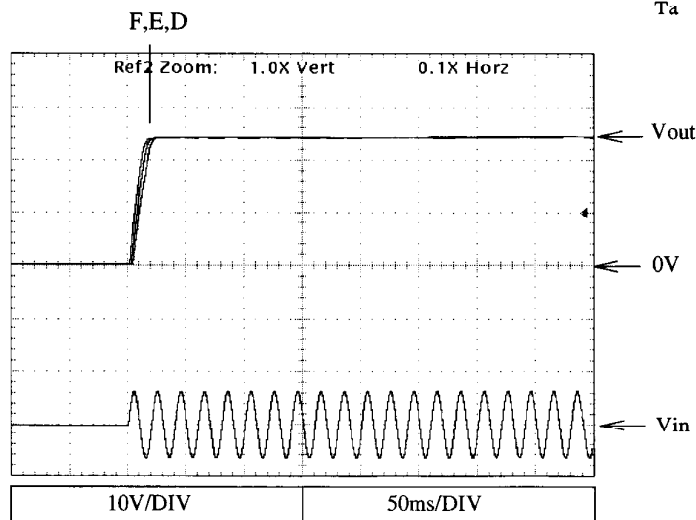



2.5 Output rise characteristics

Conditions; Vin : 85VAC (A)  
 : 100VAC (B)  
 : 132VAC (C)  
 Iout : 100%  
 Ta : 25°C

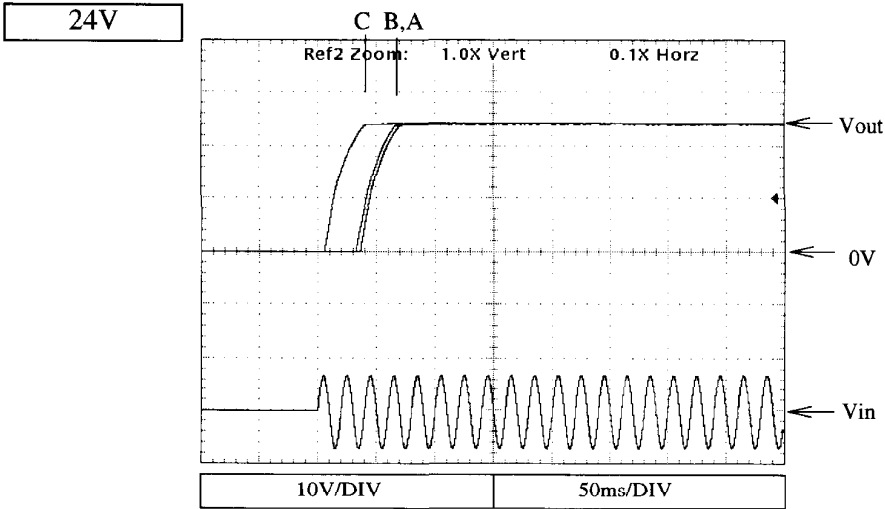

Conditions; Vin : 170VAC (D)  
 : 230VAC (E)  
 : 265VAC (F)  
 Iout : 100%  
 Ta : 25°C

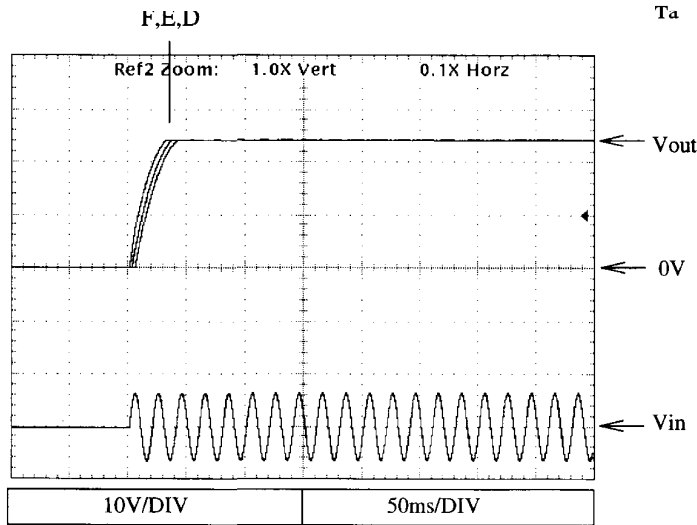

2.6 Output fall characteristics

Conditions Vin : 85VAC (A)  
 : 100VAC (B)  
 : 132VAC (C)  
 Iout : 0%  
 Ta : 25°C

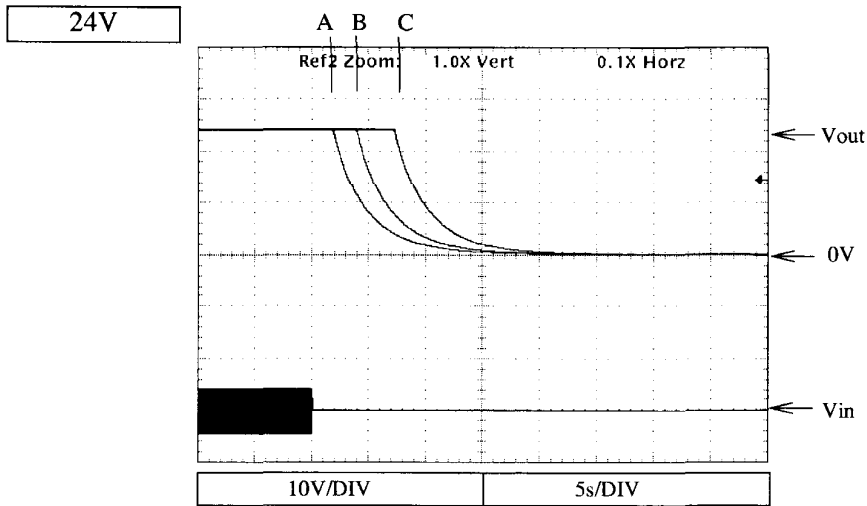

Conditions Vin : 170VAC (D)  
 : 230VAC (E)  
 : 265VAC (F)  
 Iout : 0%  
 Ta : 25°C

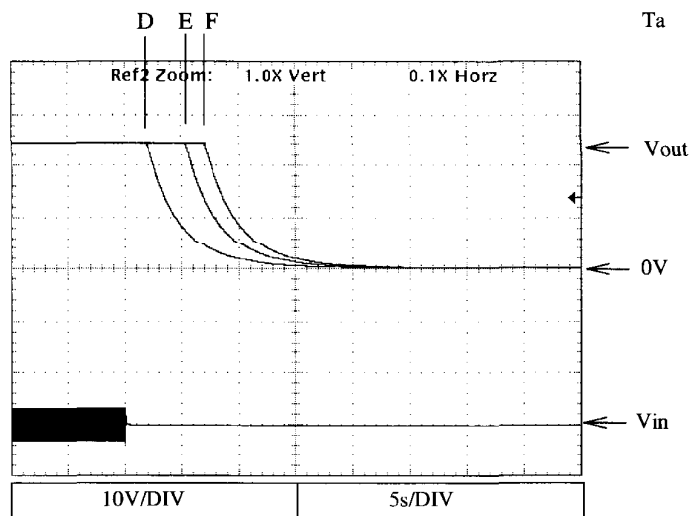

2.6 Output fall characteristics

Conditions; Vin : 85VAC (A)  
 : 100VAC (B)  
 : 132VAC (C)  
 Iout : 100%  
 Ta : 25°C

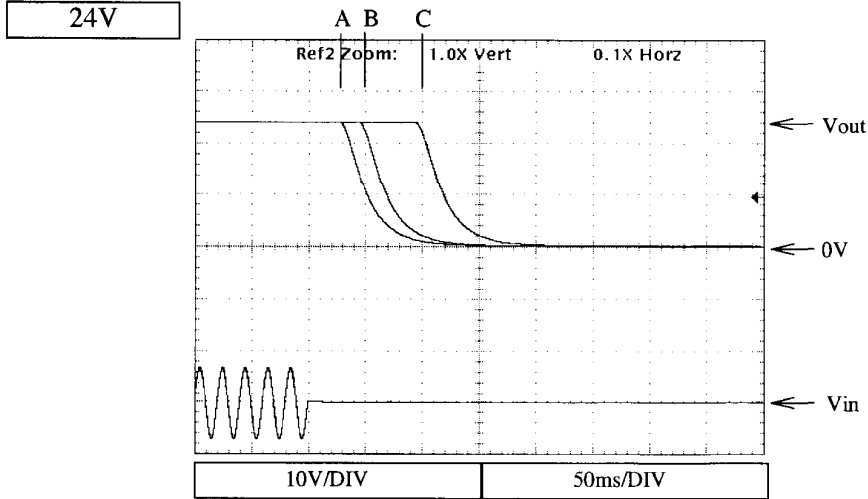

Conditions; Vin : 170VAC (D)  
 : 230VAC (E)  
 : 265VAC (F)  
 Iout : 100%  
 Ta : 25°C

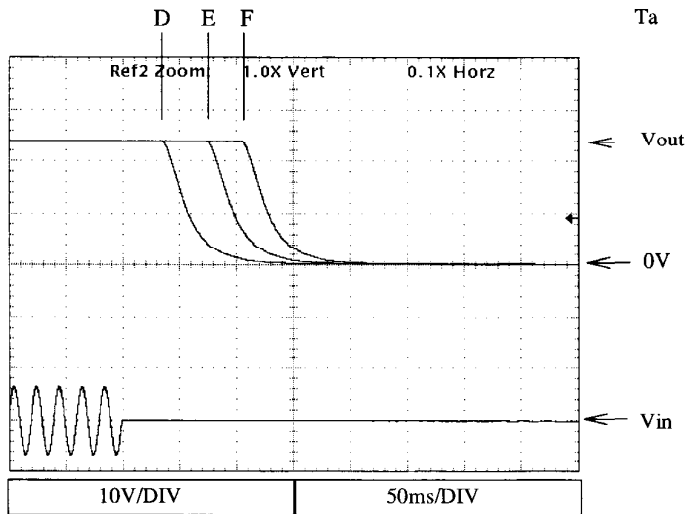

2.7 Dynamic line response characteristics

Conditions Vin : 85VAC ↔ 132VAC(A)  
170VAC ↔ 265VAC(B)  
Iout : 100%  
Ta : 25°C

24V

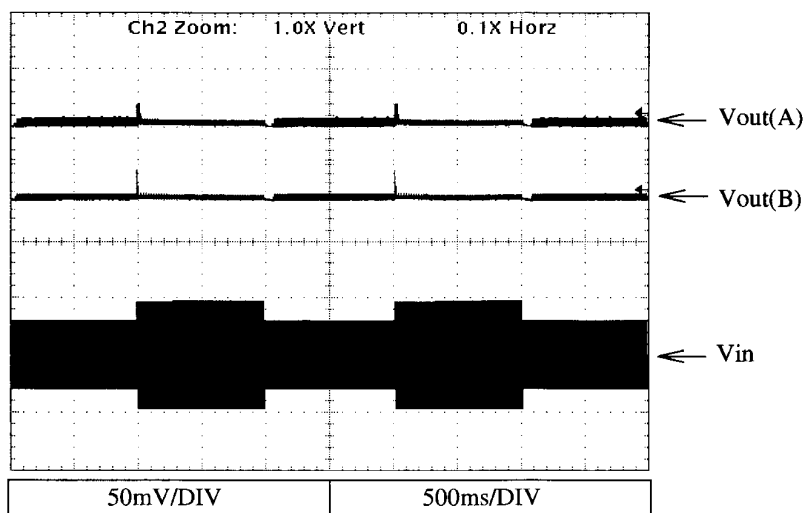

2.8 Input voltage DIP test

Conditions Ta : 25°C  
Iout : 100%

24V

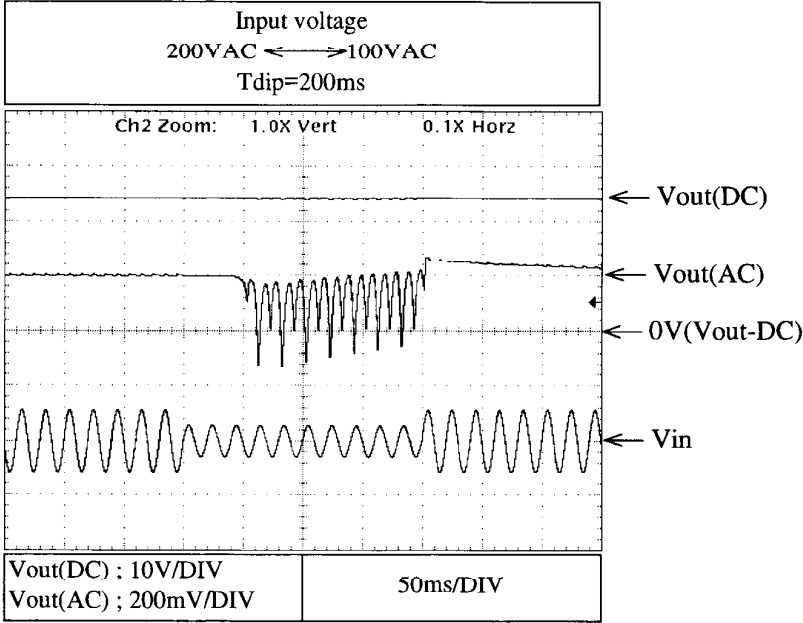

2.9 Dynamic load response characteristics

Conditions; Vin : 100VAC  
Ta : 25°C

24V

f=100Hz

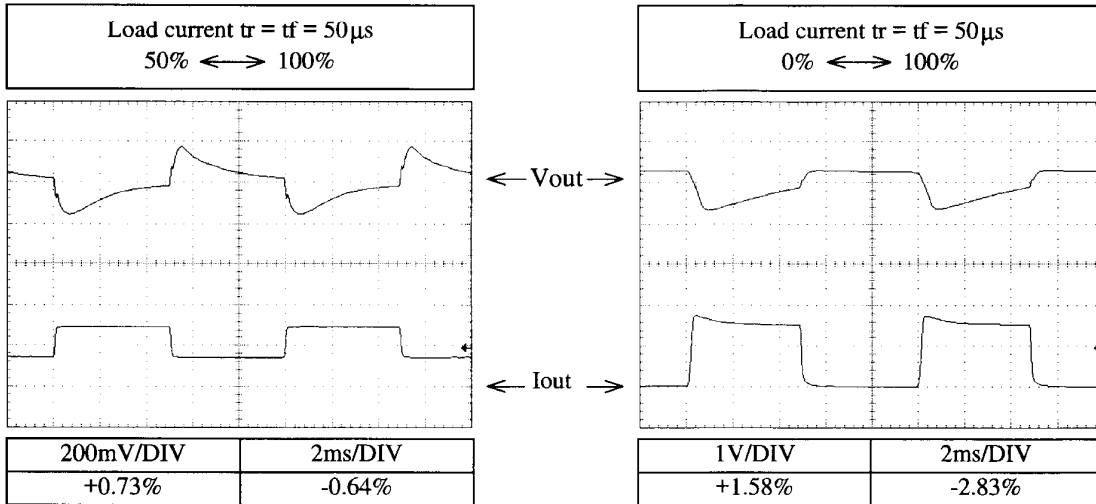

f=1kHz

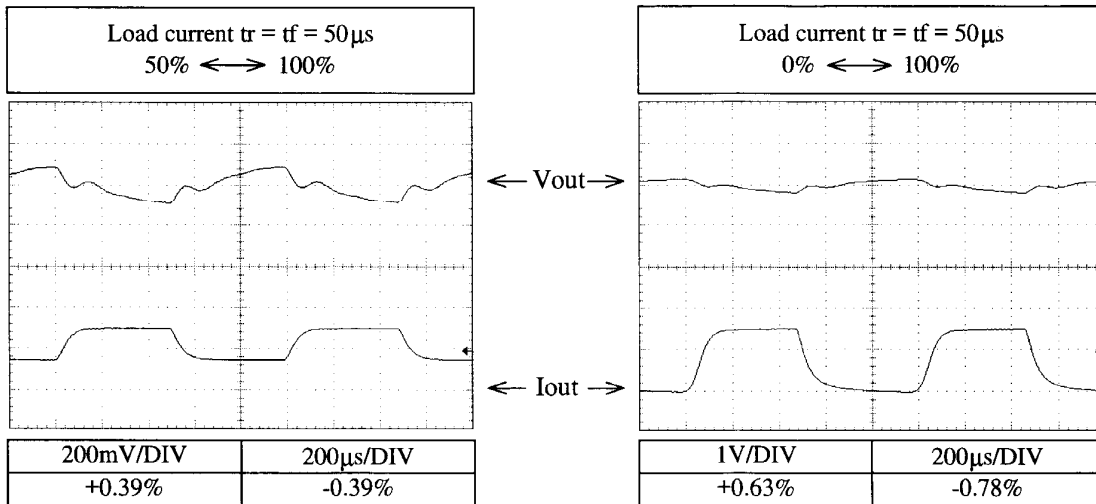

2.10 Response to brown out characteristics

Conditions Vin : 100VAC  
Iout : 100%  
Ta : 25°C

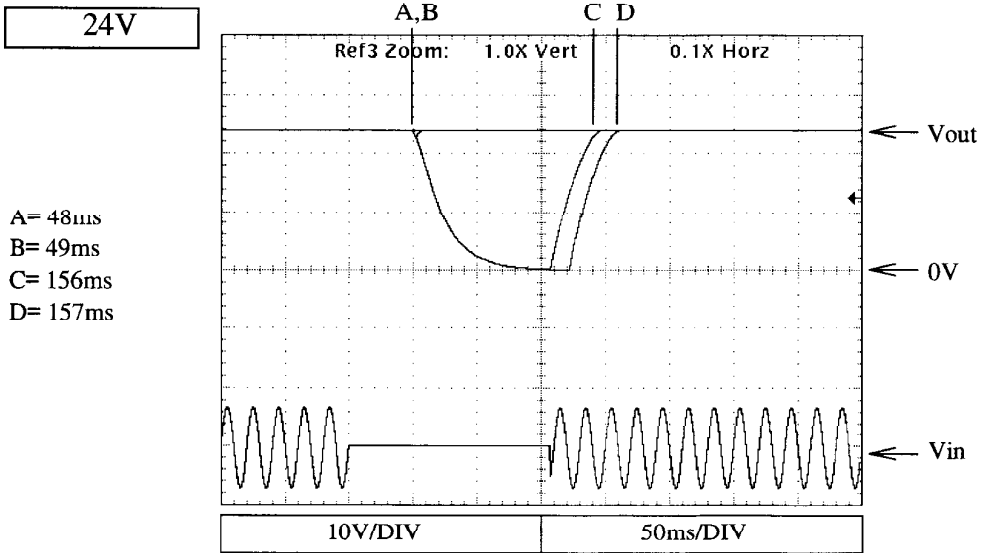

Conditions Vin : 230VAC  
Iout : 100%  
Ta : 25°C

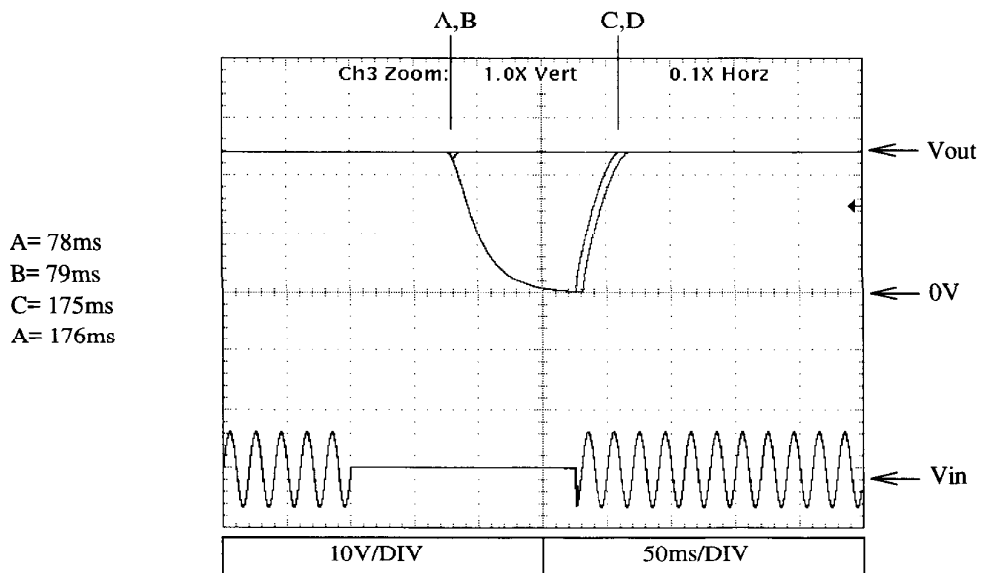

2.11 Inrush current waveform

Conditions; Vin : 100VAC  
Iout : 100%  
Ta : 25°C

24V

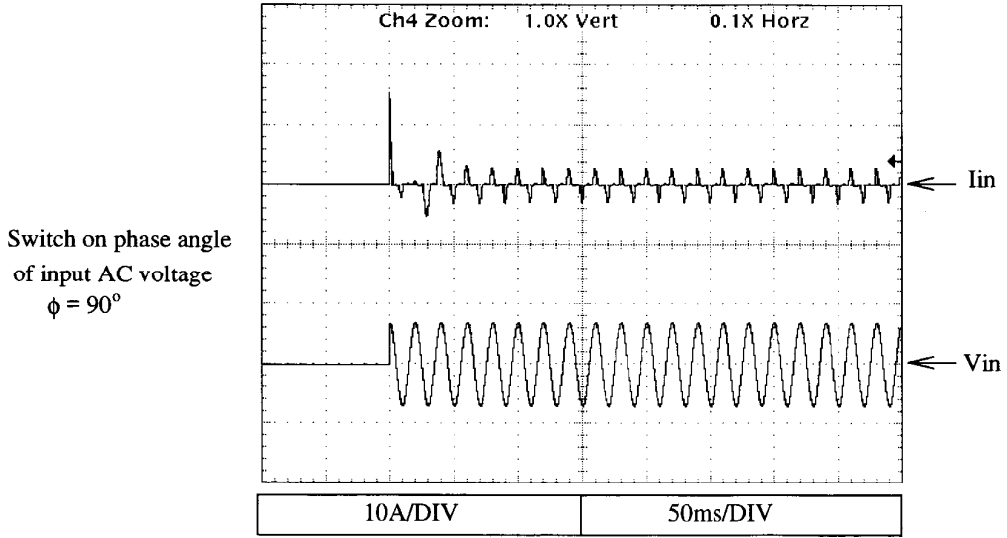
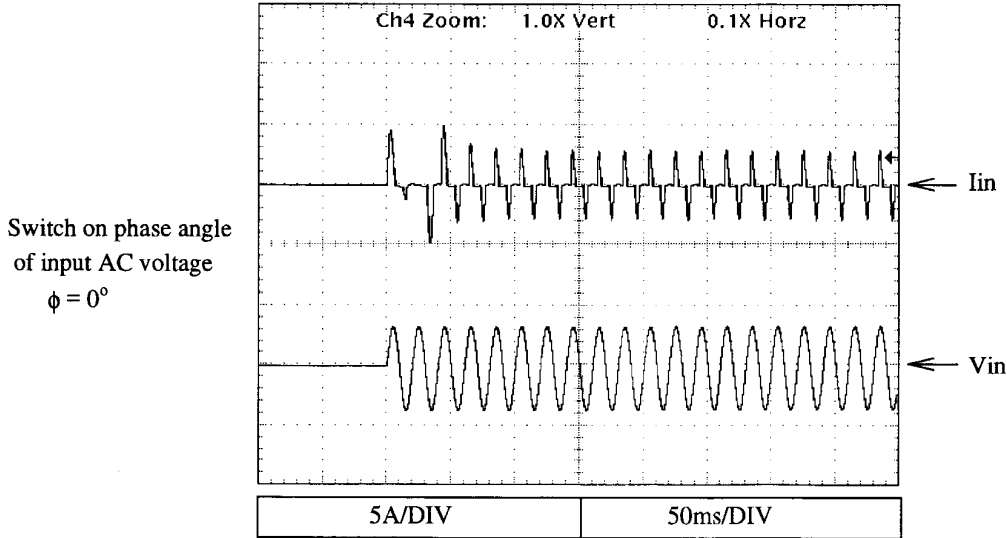



2.11 Inrush current waveform

Conditions Vin : 230VAC  
Iout : 100%  
Ta : 25°C

24V

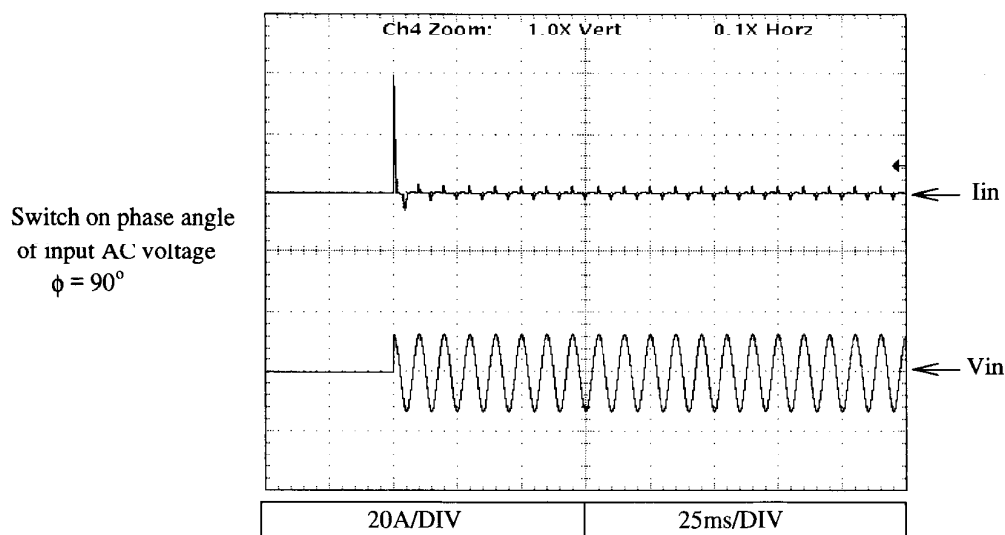
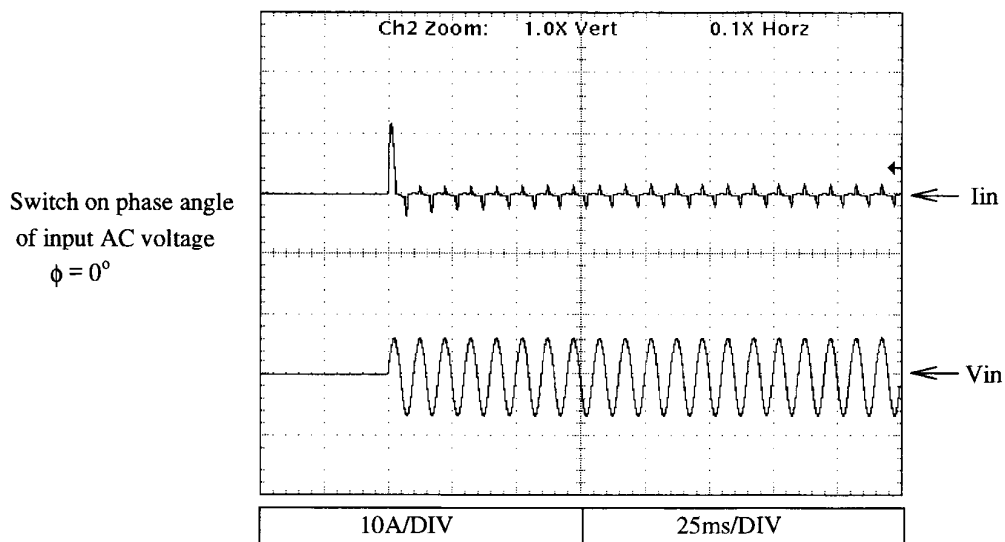

2.12 Input current waveform

24V

Conditions;  $V_{in}$  : 100VAC  
 $I_{out}$  : 100%  
 $T_a$  : 25°C

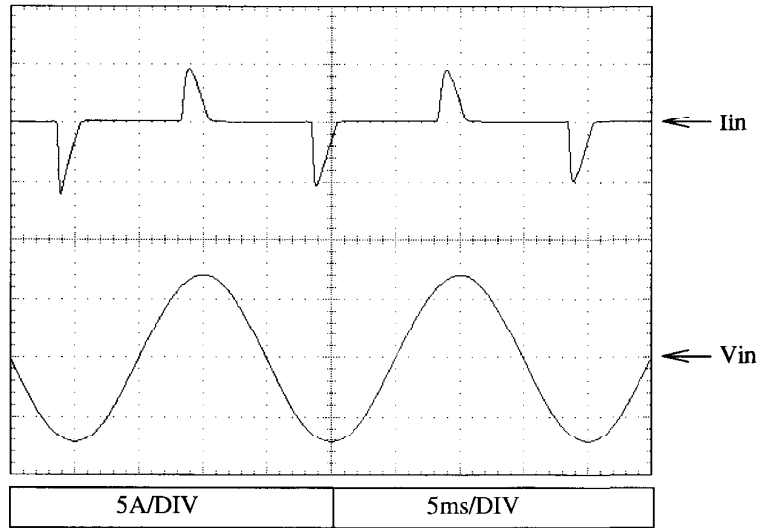

Conditions;  $V_{in}$  : 230VAC  
 $I_{out}$  : 100%  
 $T_a$  : 25°C

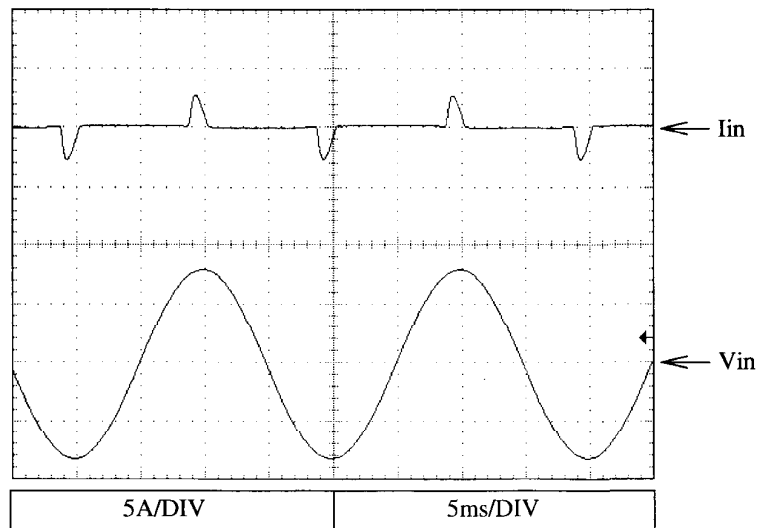

2.13 Input current harmonics

24V

Conditions: Vin : 100VAC  
Iout : 100%  
Ta : 25°C

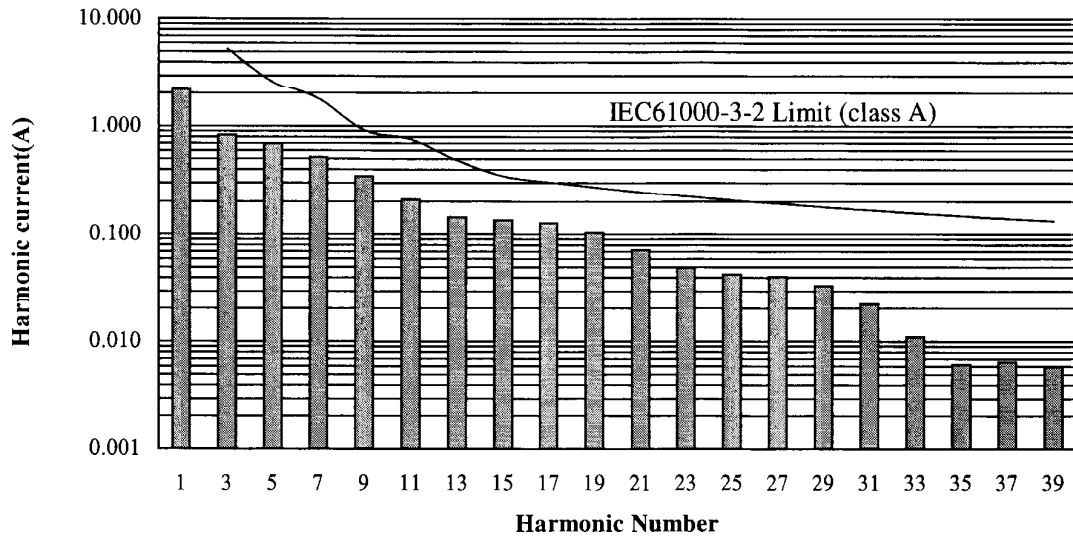

Conditions; Vin : 230VAC  
Iout : 100%  
Ta : 25°C

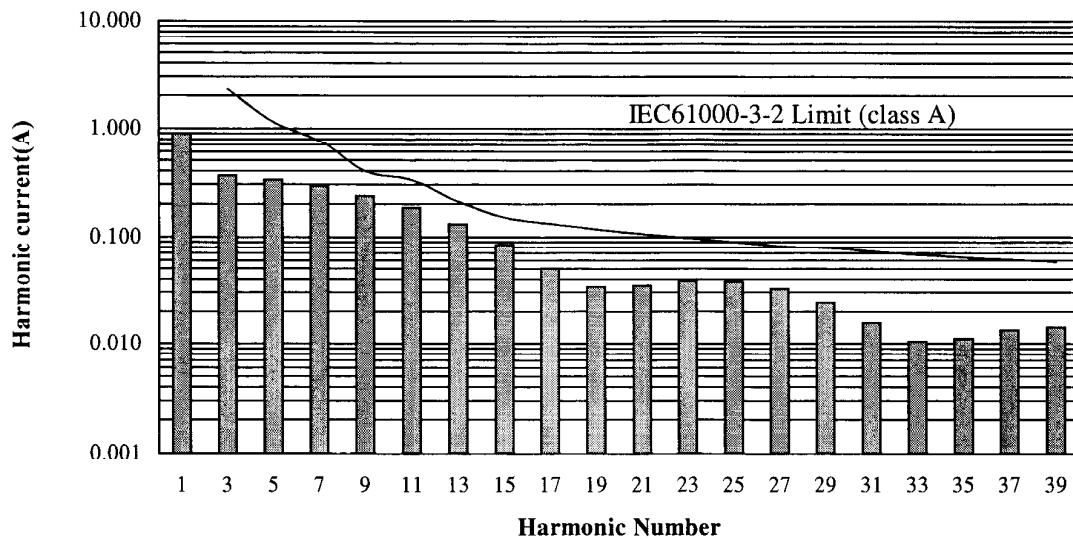

2.14 Leakage current characteristics

24V

Conditions; Iout : 0% -----  
 : 100% —————  
 Ta : 25°C  
 f : 50Hz  
 Equipment used : MODEL 229-2 (Simpson)

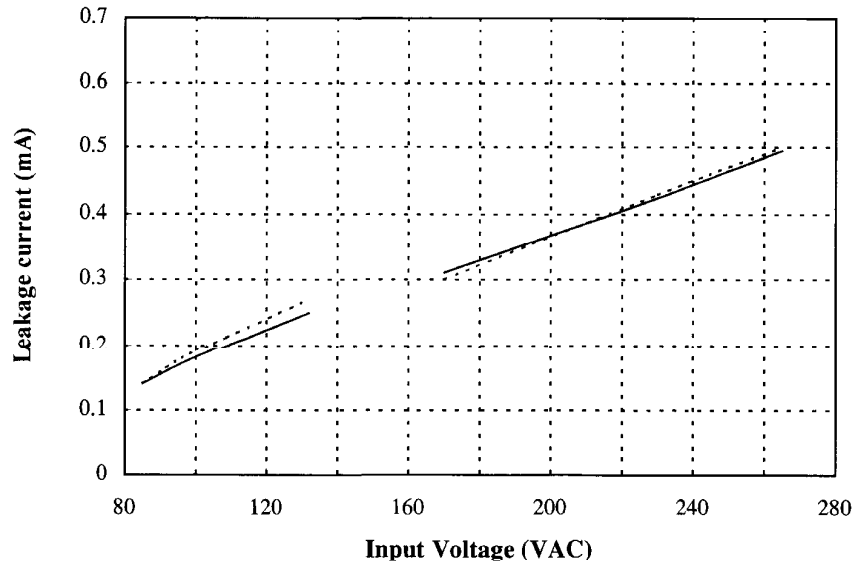

Conditions; Iout : 0% -----  
 : 100% —————  
 Ta : 25°C  
 f : 50Hz  
 Equipment used : TYPE 3226 (YOKOGAWA)

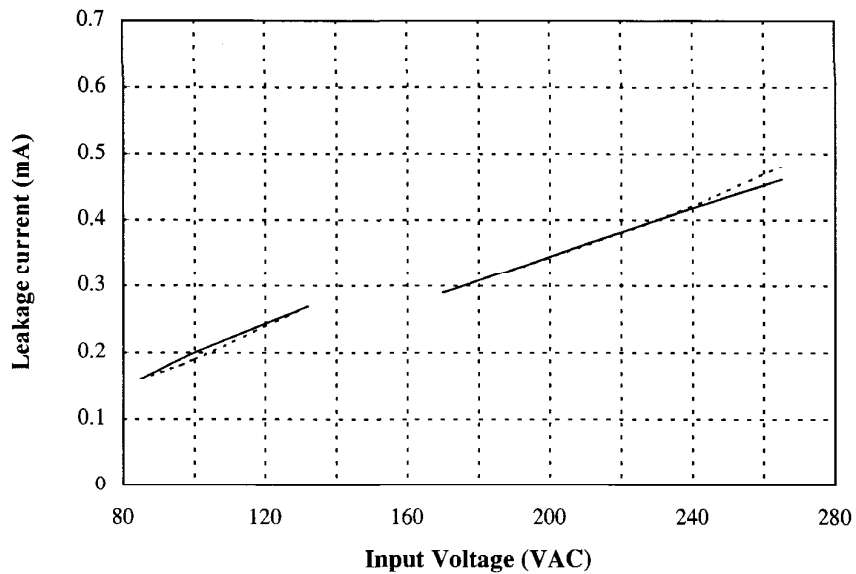

2.15 Output ripple and noise waveform

Conditions; Vin : 100VAC  
Iout : 100%  
Ta : 25°C

NORMAL MODE

24V

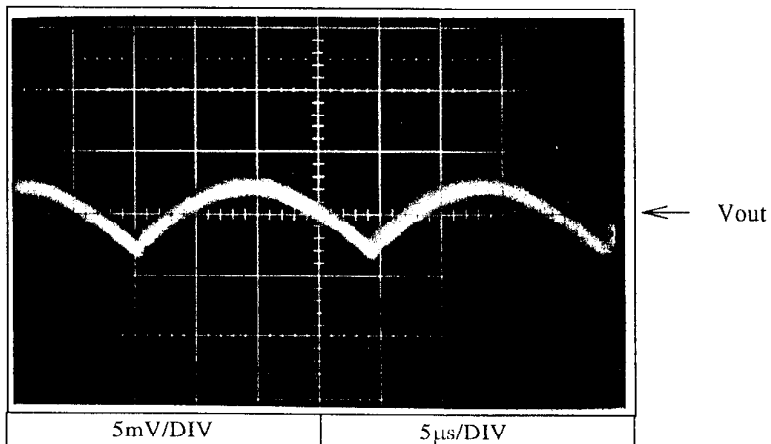

NORMAL + COMMON MODE

Conditions Vin : 100VAC  
Iout : 100%  
Ta : 25°C

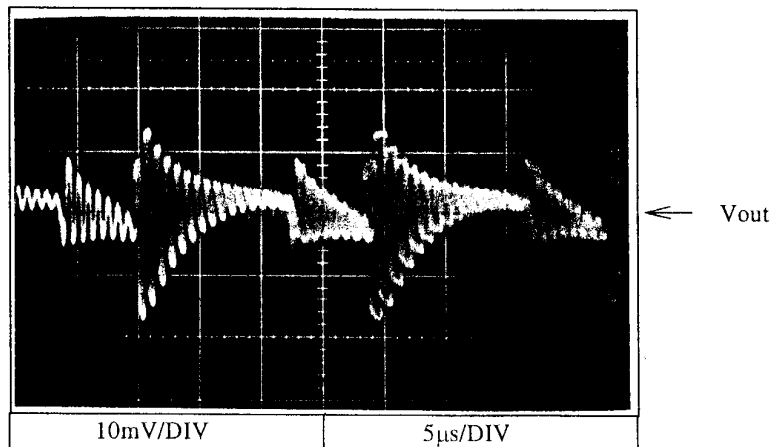

2.16 Stand-by current

Conditions; Ta : 25°C  
Iout : 0%

24V

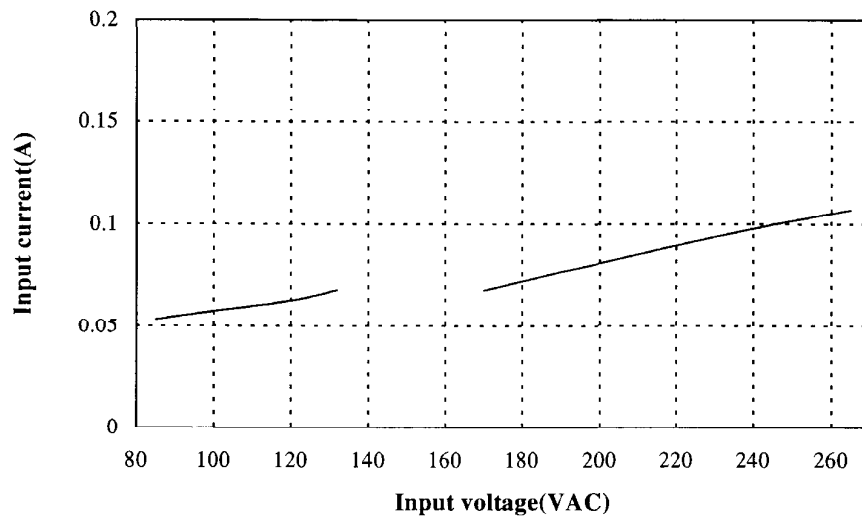

2.17 Hold up time characteristics

Conditions Vin : 100VAC -----  
: 230VAC -----  
Ta : 25°C

24V

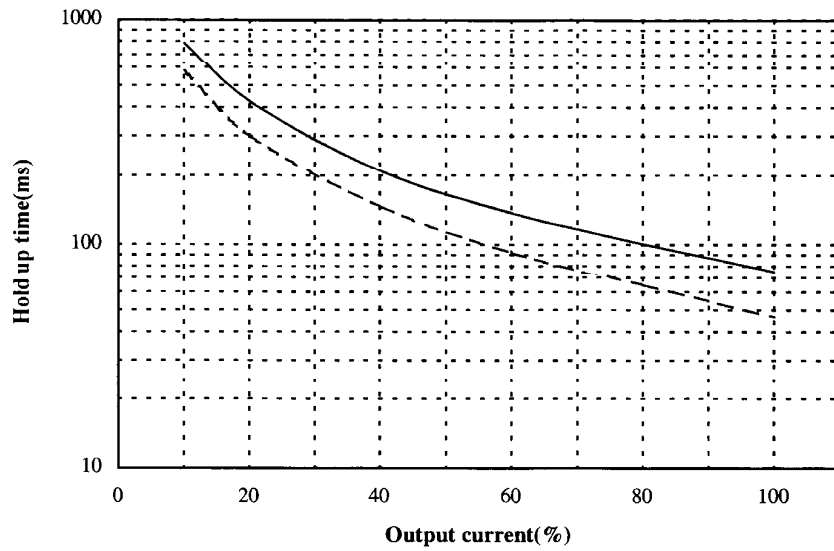

2.18 Electro-Magnetic Interference characteristics

Conducted Emission

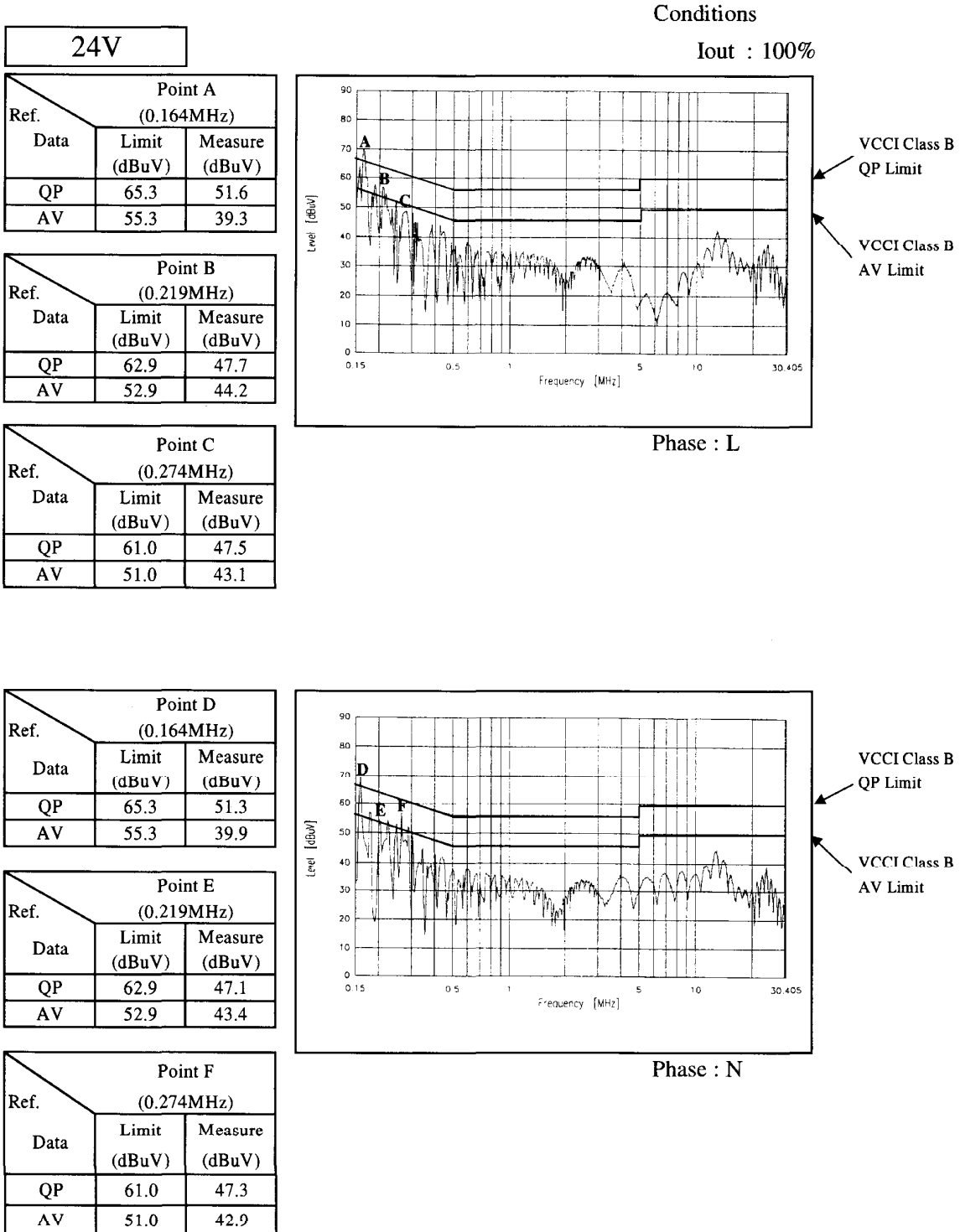

Limits of EN55022-B,FCC Class B are same as VCCI class B.



2.18 Electro-Magnetic Interference characteristics

Conducted Emission

24V

Conditions  
 Vin : 230VAC  
 Iout : 100%

Point A (0.183MHz)		
Ref.	Limit (dBuV)	Measure (dBuV)
QP	64.3	51.7
AV	54.3	47.3

Point B (0.306MHz)		
Ref.	Limit (dBuV)	Measure (dBuV)
QP	60.1	46.1
AV	50.1	44.0

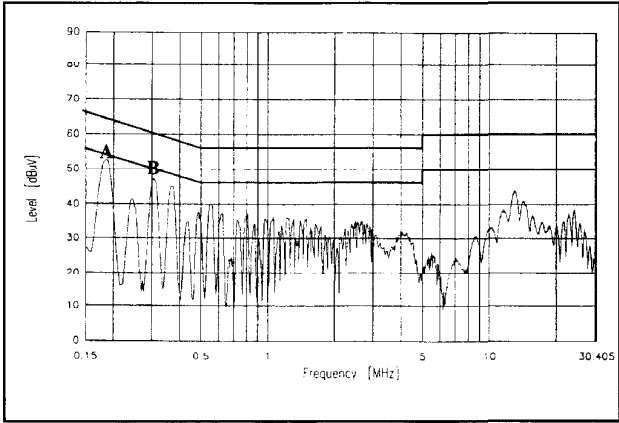

Phase : L

Point C (0.184MHz)		
Ref.	Limit (dBuV)	Measure (dBuV)
QP	64.3	51.7
AV	54.3	47.5

Point D (0.306MHz)		
Ref.	Limit (dBuV)	Measure (dBuV)
QP	60.1	45.5
AV	50.1	43.6

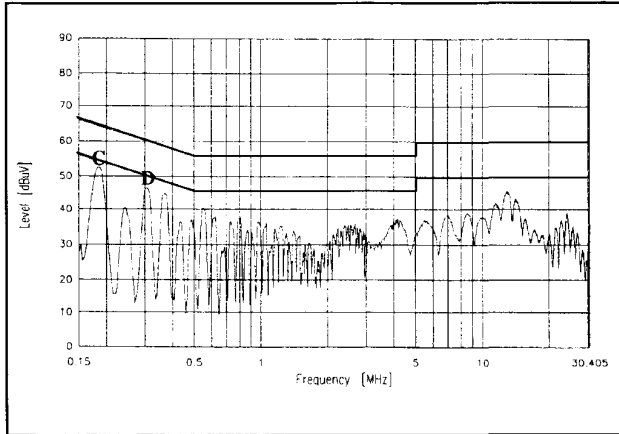

Phase : N

Limits of EN55022-B,FCC Class B are same as VCCI class B.

2.18 Electro-Magnetic Interference characteristics

Radiated Emission

24 V  
HORIZONTAL:

Conditions  
Vin : 100VAC  
Iout : 100%

Point A (173.7MHz)	
Limit (dBuV/m)	Measure (dBuV/m)
40.0	30.2

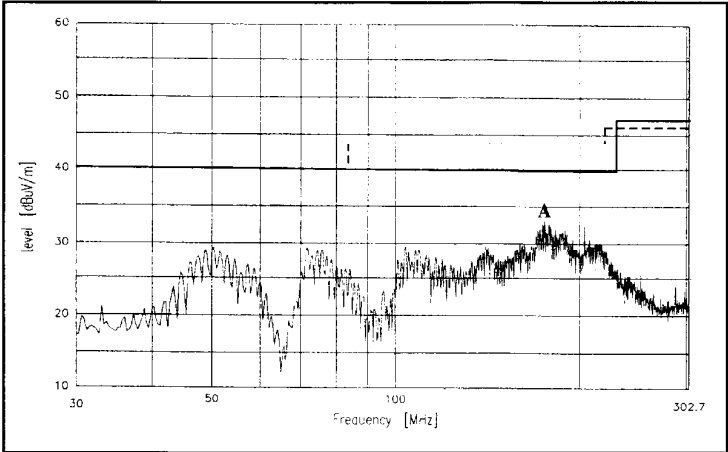

VCCI Class B  
QP Limit  
FCC Class B  
QP Limit

VERTICAL:

Point B (71.4MHz)	
Limit (dBuV/m)	Measure (dBuV/m)
40.0	34.6

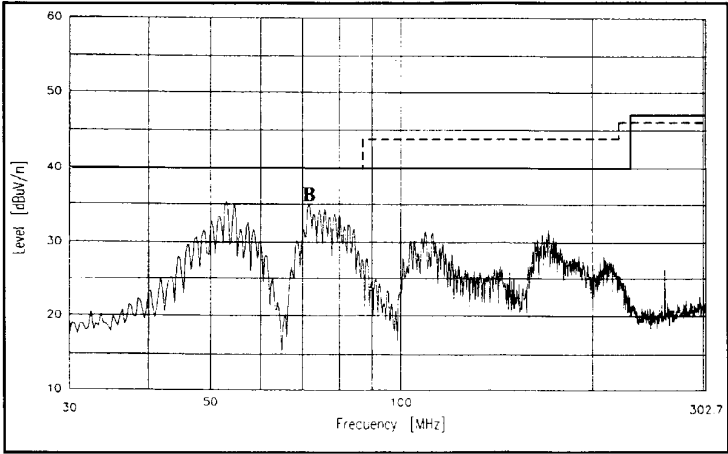

VCCI Class B  
QP Limit  
FCC Class B  
QP Limit

Limits of EN55022-B are same as its VCCI class B.

2.18 Electro-Magnetic Interference characteristics

Radiated Emission

24V  
HORIZONTAL:

Conditions  
Vin : 230VAC  
Iout : 100%

Point A (173.4MHz)	
Limit (dBuV/m)	Measure (dBuV/m)
40.0	32.2

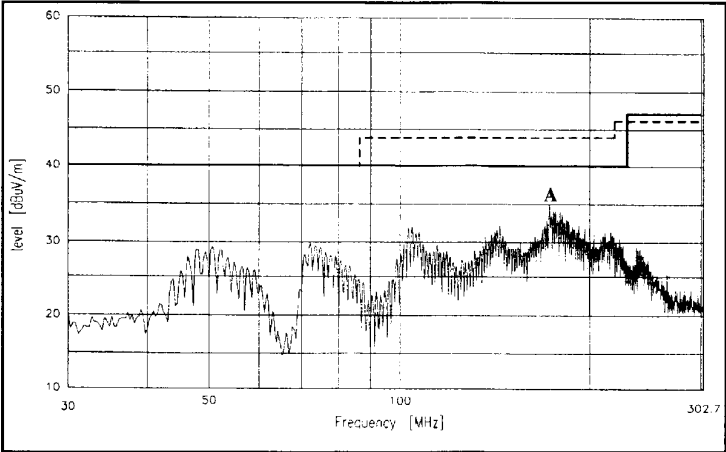

VERTICAL:

Point B (72.1MHz)	
Limit (dBuV/m)	Measure (dBuV/m)
40.0	35.1

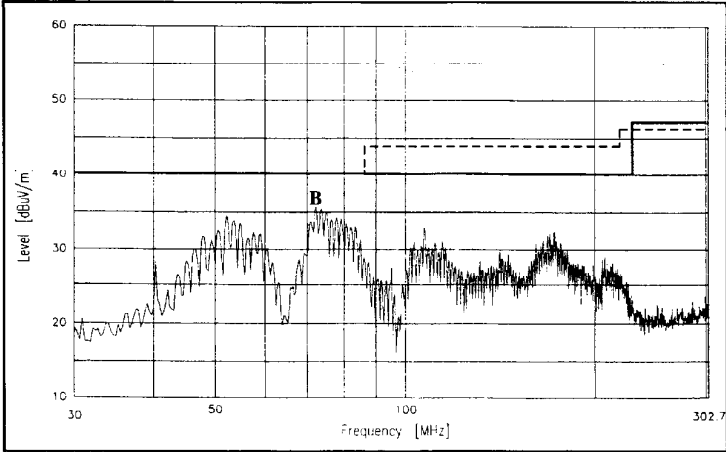

Limits of EN55022-B are same as its VCCI class B.