

ZUP-800 SERIES TEST DATA IEC1000

DWG: IA550-58-01			
QA APPD	APPD	CHK	DWG
אורי גל Oct/20/00	Doron Peled Sep-20-00	Oleg. B 27-June-00	Michael G. 27.06.2000

 **NEMIC-LAMBDA LTD.**

INDEX

1. Electro-Static Discharge Test.....R-1
IEC1000-4-2
2. Radiated Susceptibility Test.....R-2
IEC1000-4-3
3. Electrical Fast Transient Burst Test.....R-3,4
IEC1000-4-4
4. Surge Test.....R-5,6
IEC1000-4-5
5. Conducted Susceptibility Test.....R-7
IEC1000-4-6
6. Input Current Harmonics Test.....R-8
IEC1000-3-2

The above data is typical value data.
The values are considered to be actual capability data.

NEMIC-LAMBDA

1. ELECTRO-STATIC DISCHARGE TEST
 (IEC1000-4-2)
M O D E L : ZUP- 800

(1) Equipment used

SCHAFFNER NSG435

Discharge resistance : 330 Ohm Capacity : 150 pF

(2) Test conditions

Input voltage : Rated

Output voltage : Rated

Output current : 100%

Polarity : +,-

Number of tests : 10 times

Discharge interval : >1 Second

(3) Test method and Device test point

Contact discharge : FG, Case screw

Air discharge : Input and Output terminal

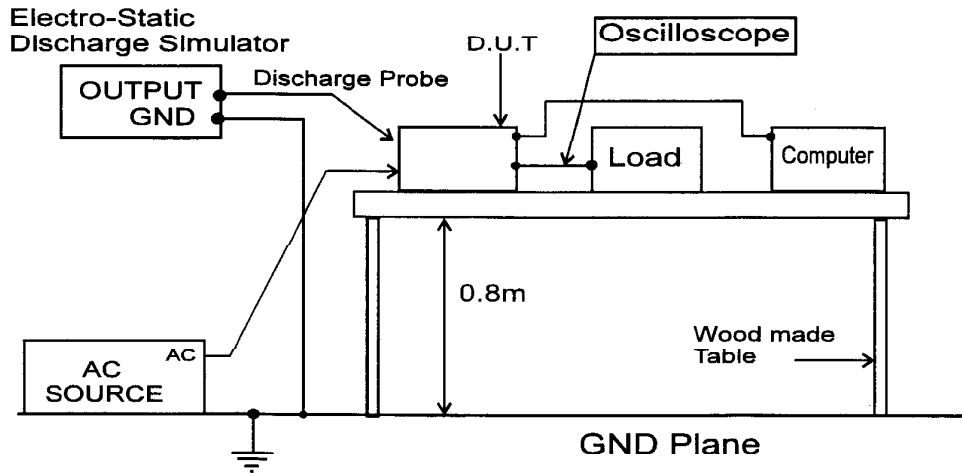

(4) Acceptable conditions

1. Output voltage regulation not to exceed $\pm 5\%$ of initial (before test) value during test.
2. Output voltage to be within regulation specification after the test.
3. Along with 1 and 2, no discharge of fire or smoke, as well as no output failure.

(5) Test Result

Contact Discharge (kV)	ZUP6-132	ZUP36-24	ZUP60-14	Air Discharge (kV)	ZUP6-132	ZUP36-24	ZUP60-14
2	PASS	PASS	PASS	2	PASS	PASS	PASS
4	PASS	PASS	PASS	4	PASS	PASS	PASS

**2.ELECTROMAGNETIC RADIATION SUSCEPTIBILITY TEST
(IEC1000-4-3)**

M O D E L : ZUP- 800

(1) Equipment used

Radiated immunity test chamber: 1JTEMCELL, Wayne Kerr
 Electronic load: PLZ1003W , KIKUSUI
 Oscilloscope: 3365A , PHILIPS
 DVM: 8840A, FLUKE

(2) Test conditions

Input voltage : Rated Output voltage : Rated
 Output current : 100% Amplitude Modulated: 80%, 1KHz
 Electromagnetic Ambient temperature: 25°C
 Frequency: 80~1000MHz

Sweep Condition: 1.5 x 10⁻³ Decade/Second, 1.0 Second Hold
 Test Angle: Top/Bottom, Both Sides, Front/Back

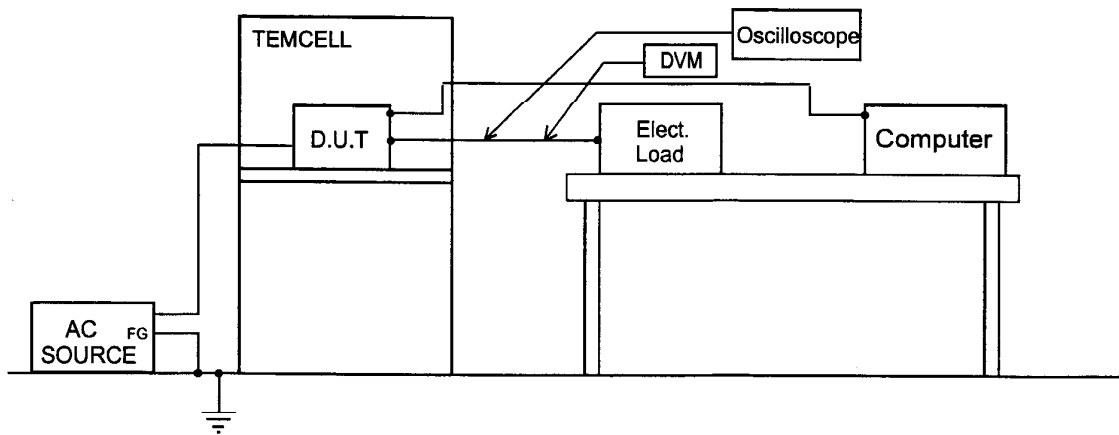

(3) Acceptable conditions

1. Output voltage regulation not to exceed ± 5% of initial (before test) value during test.
2. Output voltage to be within regulation specification after the test.
3. Along with 1 and 2, no discharge of fire or smoke, as well as no output failure.

(4) Test Result

Radiation Field Strength (V/m)	ZUP6-132	ZUP36-24	ZUP60-14
1	PASS	PASS	PASS
2	PASS	PASS	PASS
3	PASS	PASS	PASS

**3. ELECTRICAL FAST TRANSIENT BURST TEST
(IEC1000-4-4)**

M O D E L : ZUP- 800

(1) Equipment used

EFT/B Generator: SCHAFFNER NSG2025

(2) Test conditions

Input voltage :	Rated	Output voltage :	Rated
Output current :	100%	Test time:	1 minute
Polarity:	+,-	Ambient temperature:	25°C
Number of tests:	3 times		

(3) Test method and Device test point

N.L.FG

Apply to N,L,FG separately, as well as, all at the same time.

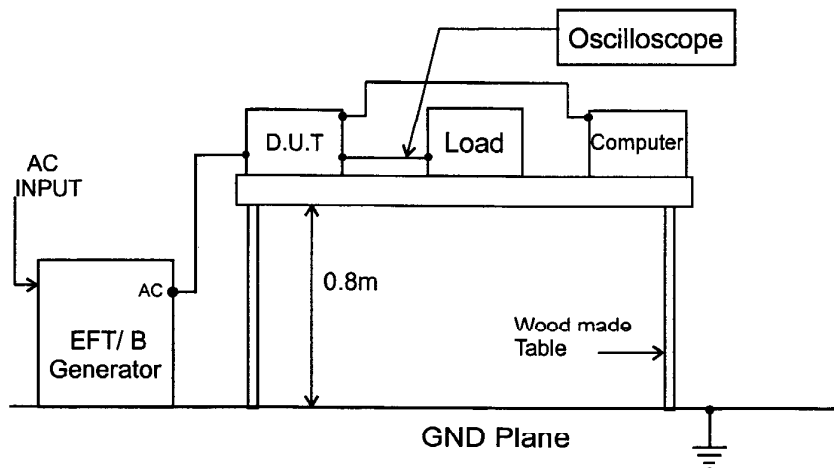

(4) Acceptable conditions

1. Output voltage regulation not to exceed $\pm 5\%$ of initial (before test) value during test.
2. Output voltage to be within regulation specification after the test.
3. Along with 1 and 2, no discharge of fire or smoke, as well as no output failure.

(5) Test Result

Test Voltage (kV)	Repetition Rate(kHz)	ZUP6-132	ZUP36-24	ZUP60-14
0.5	5	PASS	PASS	PASS
1	5	PASS	PASS	PASS
2	5	PASS	PASS	PASS

**3. ELECTRICAL FAST TRANSIENT BURST TEST
(IEC1000-4-4)**

M O D E L : ZUP- 800

(1) Equipment used

EFT/B Generator: SCHAFFNER NSG2025

(2) Test conditions

Input voltage :	Rated	Output voltage :	Rated
Output current :	100%	Test time:	1 minute
Polarity:	+,-	Ambient temperature:	25°C
Number of tests:	3 times		

**(3) Test method and Device test point
Communication lines**

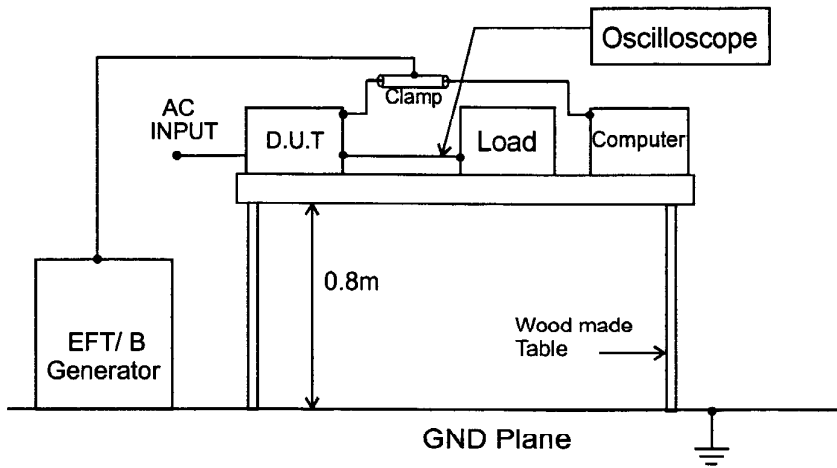

(4) Acceptable conditions

1. Output voltage regulation not to exceed $\pm 5\%$ of initial (before test) value during test.
2. Output voltage to be within regulation specification after the test.
3. Along with 1 and 2, no discharge of fire or smoke, as well as no output failure.

(5) Test Result

Test Voltage (kV)	Repetition Rate(kHz)	ZUP6-132	ZUP36-24	ZUP60-14
0.5	5	PASS	PASS	PASS

4. SURGE TEST
 (IEC1000-4-5)
M O D E L : ZUP- 800

(1) Equipment used

Surge Generator: SCHAFFNER - NSG651
 Coupling impedance: Common - 12 OHm
 Normal - 2 OHm
 Coupling capacitance: Common - 9uF
 Normal - 18uF
 Coupling network: SCHAFFNER - CDN110

(2) Test method and device test point

Input Voltage:	Rated	Output Voltage:	Rated
Output Current:	100%	Number of tests:	5 times
Polarity:	+, -	Mode:	Common, Normal
Phase:	0, 90 DEG.	Ambient Temperature:	25 C

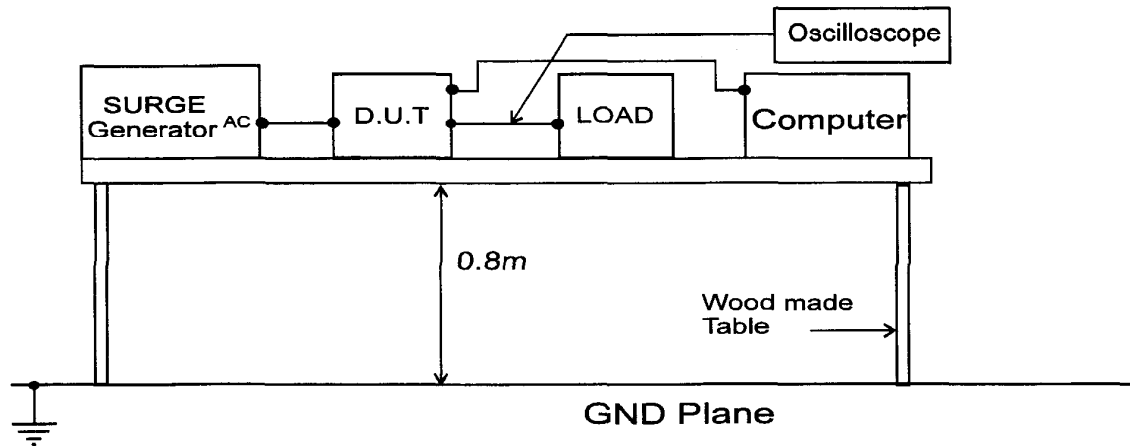

(4) Acceptable conditions

1. Output voltage regulation not to exceed $\pm 5\%$ of initial (before test) value during test.
2. Output voltage to be within regulation specification after the test.
3. Along with 1 and 2, no discharge of fire or smoke, as well as no output failure.

(5) Test Result

Test Voltage (kV) Common	ZUP6-132	ZUP36-24	ZUP60-14	Test Voltage (kV) Normal	ZUP6-132	ZUP36-24	ZUP60-14
0.5	PASS	PASS	PASS	0.5	PASS	PASS	PASS
1.0	PASS	PASS	PASS	1	PASS	PASS	PASS
2.0	PASS	PASS	PASS				

4. SURGE TEST
(IEC1000-4-5)
M O D E L : ZUP- 800

(1) Equipment used

Surge Generator: SCHAFFNER - NSG651
Coupling impedance: Common - 12 OHm
Normal - 2 OHm
Coupling capacitance: Common - 9uF
Normal - 18uF
Coupling network: SCHAFFNER - CDN110

(2) Test method and device test point
communication lines

Input Voltage: Rated Output Voltage: Rated
Output Current: 100% Number of tests: 5 times
Polarity: +, - Mode: Common.

Phase: 0, 90 DEG. Ambient Temperature: 25°C

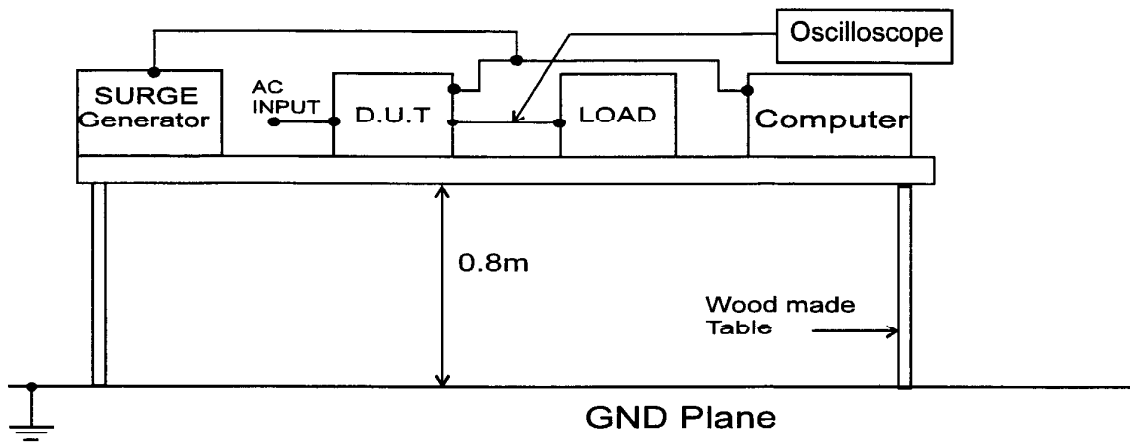

(4) Acceptable conditions

1. Output voltage regulation not to exceed $\pm 5\%$ of initial (before test) value during test.
2. Output voltage to be within regulation specification after the test.
3. Along with 1 and 2, no discharge of fire or smoke, as well as no output failure.

(5) Test Result

Test Voltage (kV) Common	ZUP6-132	ZUP36-24	ZUP60-14
0.5	PASS	PASS	PASS
1.0	PASS	PASS	PASS

5. CONDUCTED SUSCEPTIBILITY TEST

(IEC1000-4-6)

M O D E L : ZUP- 800

(1) Equipment used

RF Signal Generator 10kHz-1050 MHz	(Fluke,6061A)
RF Amplifier 10 kHz-220 MHz,150W	(Amplifier Research, 150L)
Coupling/Decoupling Network	(HL CDN 801-M3)

(2) Test conditions

Input Voltage:	Rated	Output Voltage:	Rated
Output Current:	100%	Electromagnetic	
		Frequency:	150KHz~80MHz
Sweep Condition:	1.0% Step Up, 2.0 Seconds Hold		
Ambient Temperature:	25°C		

(3) Test method

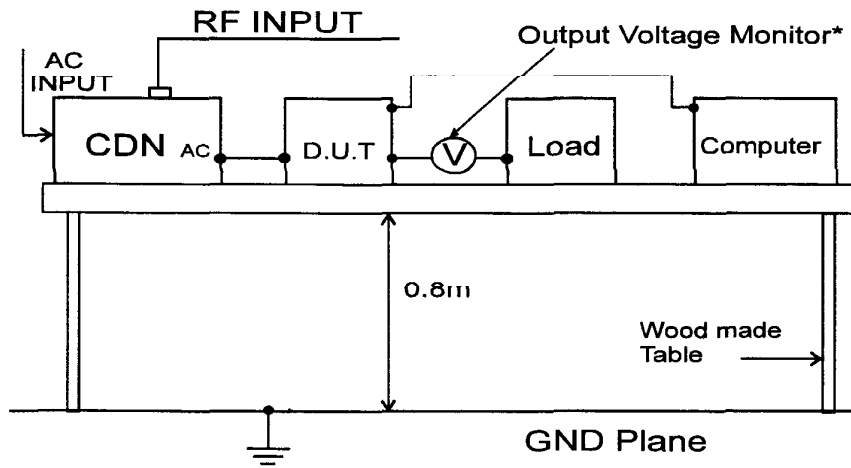

*Used Oscilloscope or Analog Voltage Meter

(4) Acceptable conditions

1. Output voltage regulation not to exceed $\pm 5\%$ of initial (before test) value during test.
2. Output voltage to be within regulation specification after the test.
3. Along with 1 and 2, no discharge of fire or smoke, as well as no output failure.

(5) Test Result

Voltage Level (V)	ZUP6-132	ZUP36-24	ZUP60-14
1	PASS	PASS	PASS
2	PASS	PASS	PASS
3	PASS	PASS	PASS

1. INPUT CURRENT HARMONICS TEST
 (IEC1000-3-2, Class A)
 M O D E L : ZUP6-132

ZUP- 800

(1) Equipment used
 AC POWER ANALYSER :
 PACS-1(CALIFORNIA INSTRUMENTS)
 AC SOURCE:
 5001 IX (CALIFORNIA INSTRUMENTS)

(2) Test conditions
 Input voltage: 100 VAC; 230 VAC
 Output current: 100%

(3) Test method

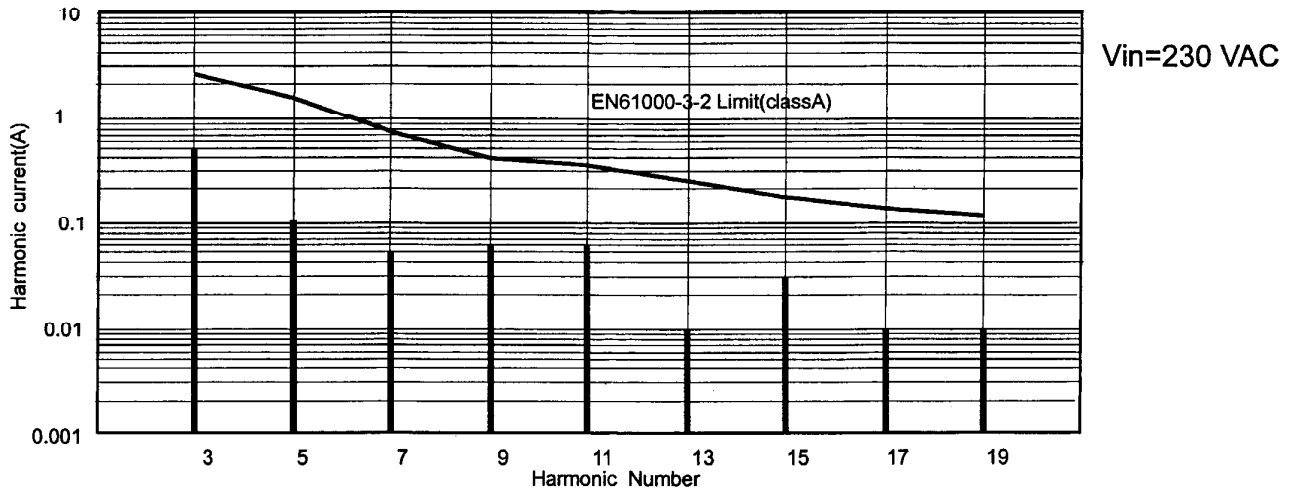
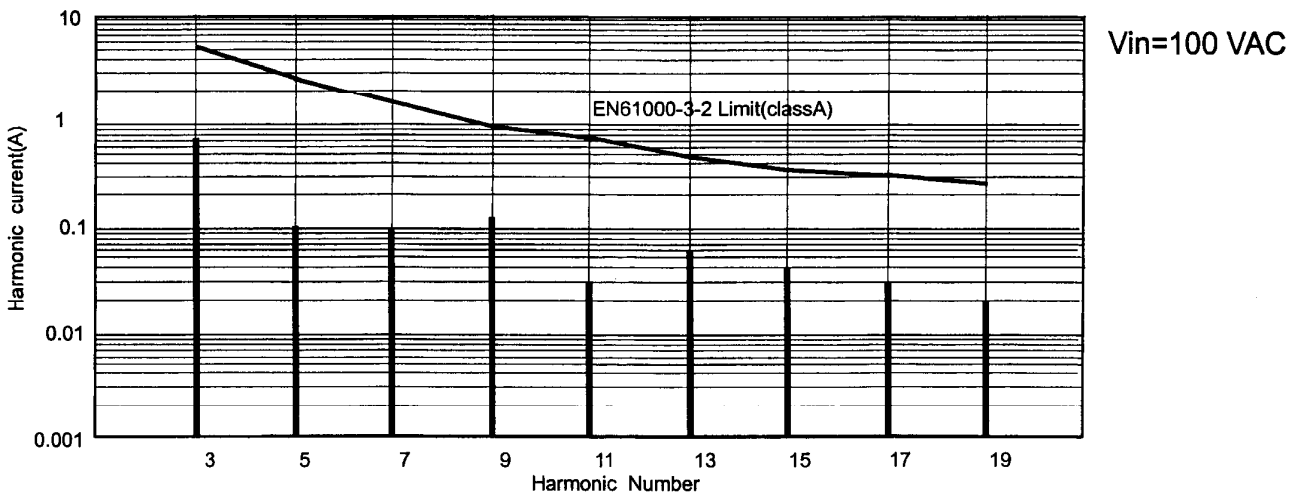
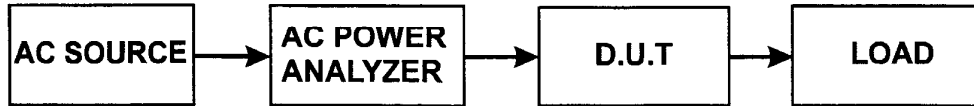

Vin	Harmonics								
	3	5	7	9	11	13	15	17	19
100 VAC	5.23	2.62	1.77	0.92	0.75	0.46	0.34	0.30	0.27
	0.740	0.110	0.100	0.130	0.030	0.060	0.040	0.030	0.020
230 VAC	2.50	1.14	0.77	0.40	0.33	0.21	0.15	0.13	0.12
	0.480	0.110	0.050	0.060	0.060	0.010	0.030	0.010	0.010

Input Current Harmonics IEC1000-3-2 limit

Input Current Harmonics -Measurement