

CCG15-24-xxD/P

C282-01-01/P

SPECIFICATIONS

ITEMS		MODEL	CCG15-24-12D/P	CCG15-24-15D/P
1	Nominal Output Voltage	V	±12	±15
2	Maximum Output Current	A	0.65	0.5
3	Nominal Output Power	W	15.6	15
4	Efficiency (Typ.) (*1)	%	89	90
5	Input Voltage Range	VDC	9 - 36	
6	Input Current (*1)	A	0.73	0.70
7	Output Voltage Accuracy (*1)	%	±5	
8	Output Voltage Range	-	Fixed	
9	Maximum Ripple & Noise (*6)	mV	95	95
10	Maximum Line Regulation (*2)	mV	60	75
11	Maximum Load Regulation (*3)	mV	120	150
12	Maximum Load Regulation (*8)	mV	480	600
13	Over Current Protection	-	105% min. (Hiccup, Automatic recovery method)	
14	Over Voltage Protection	-	-	
15	Remote ON/OFF control (*5)	-	Possible (SHORT : OFF OPEN : ON)	
16	Parallel Operation	-	-	
17	Series Operation (*5)	-	Possible	
18	Operating Temperature (*4)	-	-40°C - +110°C(Case) , -40°C - +85°C(Ambient)	
19	Operating Humidity	-	5 - 95%RH (No Dewdrop)	
20	Storage Temperature	-	-55°C - +125°C	
21	Storage Humidity	-	5 - 95%RH (No Dewdrop)	
22	Cooling	-	Convection cooled / Forced air cooled	
23	Temperature Coefficient	-	0.02%/°C	
24	Withstand Voltage (*7)	-	Input-Case : 1.0kVDC for 1min. (10mA) , Input-Output : 1.5kVDC for 1min. (10mA) Output-Case : 1.0kVDC for 1min. (10mA)	
25	Isolation Resistance	-	Output to Case 500VDC more than 100MΩ (25°C,70%RH)	
26	Vibration	-	At No Operating, 10-55Hz (Sweep for 3min.) Amplitude 1.52 mm Constant (Maximum 90.8m/s ²) X,Y,Z 1 hour each	
27	Shock	-	490.3m/s ²	
28	Safety	-	Approved by UL60950-1, CSA60950-1, EN60950-1 UL62368-1, CSA62368-1, EN62368-1	
29	Weight (Typ.)	g	20	
30	Size (W x H x D)	mm	25.4 x 9.9 x 25.4 (Refer to Outline Drawing)	

*Read instruction manual carefully, before using the power supply unit.

=NOTES=

*1. At 24VDC and maximum output current.

(Ambient Temperature = +25°C.)

*2. 9 - 36VDC, Constant load.

*3. No Load - Full Load, Constant input voltage. (Balanced load)

*4. Rating - Refer to instruction manual.

*5. Refer to Instruction Manual.

*6. External components are needed for operation.

(Refer to basic connection and instruction manual.)

*7. This specification applies to power supply module as stand-alone.

*8. One side fixed Full Load, the other side 20% - Full Load, Constant input voltage. (Asymmetrical load)

CCG15-24-xxD/P

C282-01-02/P

BASIC CONNECTION

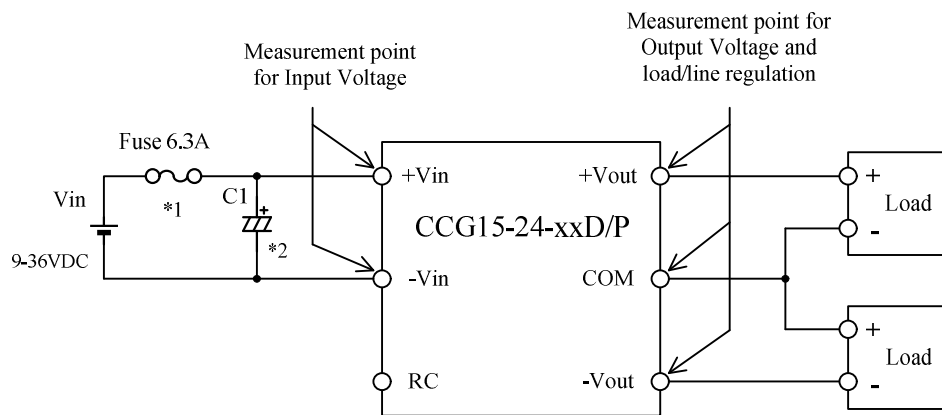

*Read instruction manual carefully, before using the power supply unit.

==NOTES==

*1. Use an external fuse (fast blow type or normal blow type) for each unit.

*2. Put input capacitor.

C1 : Electrolytic capacitor More than 50V, 120uF

- 1) Use low impedance electrolytic capacitor with excellent temperature characteristics.
- 2) If the impedance of input line is high, C1 capacitance must be more than above.