

SPECIFICATIONS (CONVECTION COOLING)

A191-01-01D

MODEL		ZWQ130-5223				ZWQ130-5225					
		V1	V2	V3	V4	V1	V2	V3	V4		
1	Nominal Output Voltage	V	+5	+12	-12	+3.3	+5	+12	-12	+5	
2	Minimum Output Current (Convection) (*1)	A	1.5	0	0	0	1.5	0	0	0	
3	Minimum Output Current (Peak Application) (*1)	A	2.1	0	0	0	2.1	0	0	0	
4	Maximum Output Current	A	15.0	4.0	4.0	10.0	15.0	4.0	4.0	10.0	
5	Total Allowable Output Power (*2)	W	130								
6	Maximum Peak Output Current (*3)	A	19.0	5.0	5.0	12.0	19.0	5.0	5.0	12.0	
7	Total Allowable Peak Output Power (*2)	W	149.6				170				
8	Efficiency (Typ) (*4)	%	72								
9	Input Voltage Range (*5)	-	85 - 265VAC (47 - 63Hz) or 120 - 370VDC								
10	Input Current (100/200VAC) (Typ) (*4)	A	2.0/1.0								
11	Inrush Current (Typ) (*6)	-	14A at 100VAC, 28A at 200VAC, Ta=25°C, Cold Start								
12	PFHC	-	Designed to meet IEC61000-3-2								
13	Power Factor (100/200VAC) (Typ) (*4)	-	0.99 / 0.93								
14	Output Voltage Range	V	5.0-5.25	+12/+15	-12/-15	2.0-3.63	5.0-5.25	+12/+15	-12/-15	2.0-5.25	
15	Output Voltage Accuracy	-	-	±5%	±5%	-	-	±5%	±5%	-	
16	Maximum Ripple & Noise (*7)	0°C ≤ Ta ≤ +60°C	mV	120	150	150	120	120	150	150	120
		-10°C ≤ Ta < 0°C	mV	160	180	180	160	160	180	180	160
17	Maximum Line Regulation (*7,8)	mV	20	48	48	20	20	48	48	20	
18	Maximum Load Regulation (*7,9)	mV	100	300	300	100	100	300	300	100	
19	Temperature Coefficient	-	Less than 0.02% /°C								
20	Over Current Protection (*10)	-	More than 152W of Total Output Power				More than 173W of Total Output Power				
21	Over Voltage Protection (*11)	V	5.7 - 7.0	16.5-22.5	-22.5 - -16.5	3.79 - 4.95	5.7 - 7.0	16.5-22.5	-22.5 - -16.5	5.7 - 7.0	
22	Hold-Up Time (Typ) (*12)	-	20 ms								
23	Leakage Current (*13)	-	0.75mA MAX, 0.2mA(Typ) at 100VAC / 0.44mA(Typ) at 230VAC								
24	Remote ON/OFF Control (*14)	-	Possible								
25	Parallel Operation	-	-								
26	Series Operation	-	-								
27	Operating Temperature (*15)	-	-10 - +60°C (-10 - +40°C : 100%, +60°C : 50%)								
28	Operating Humidity	-	30 - 90%RH (No Dewdrop)								
29	Storage Temperature	-	-30 - +85°C								
30	Storage Humidity	-	10 - 95%RH (No Dewdrop)								
31	Cooling	-	Convection Cooling								
32	Withstand Voltage	-	Input - FG : 2kVAC(20mA), Input - Output : 3kVAC (20mA) Output - FG : 500VAC(100mA), for 1min.								
33	Isolation Resistance	-	More than 100MW at 25°C and 70%RH Output - FG : 500VDC								
34	Vibration	-	At no operating, 10-55Hz (Sweep for 1min) 19.6 m/s <sup>2</sup> Constant, X, Y, Z 1h each.								
35	Shock (In package)	-	Less than 196.1 m/s <sup>2</sup>								
36	Safety (*16)	-	Approved by UL60950-1, CSA C22.2 No.60950-1, EN60950-1. Designed to meet DENAN								
37	EMI	-	Designed to meet EN55011/EN55022-B, FCC-ClassB, VCCI-B								
38	Immunity (*17)	-	Designed to meet EN61000-4-2, -3, -4, -5, -6, -8, -11								
39	Weight (Typ)	-	730g								
40	Size (WxHxD)	mm	106 x 35 x 225 (Refer to Outline Drawing)								

\*Read instruction manual carefully, before using the power supply unit.

=NOTES=

- \*1. For V2, V3, V4 stability, require minimum output current of V1.
- \*2. Allowable output power is changed according to V4 voltage, refer to derating table (A191-01-05\_).
- \*3. Operating period at peak current is less than 10sec. (Duty≤0.35)
- \*4. At 100/200VAC, Ta=25°C and total allowable output power.
- \*5. For cases where conformance to various safety specs (UL, CSA, EN) are required, to be described as 100 - 240VAC(50/60Hz).
- \*6. Not applicable for the inrush current to Noise Filter for less than 0.2ms.
- \*7. Refer to output measuring (A191-01-07\_) for line & load regulation and ripple voltage.
- \*8. 85 - 265VAC , constant load.
- \*9. Minimum load - Full load, constant input voltage.
- \*10. Constant current limit with automatic recovery. Refer to test data (A191-53-01\_).  
Not operate at over load or dead short condition for more than 30 seconds.
- \*11. OVP circuit will shut down all outputs, manual reset (Line recycle).
- \*12. At 100/200VAC, nominal output voltage and total allowable output power.
- \*13. Measured by the each method of UL, CSA, EN and DENAN (at 60Hz), Ta=25°C.
- \*14. For using, refer to note (A191-01-07\_).
- \*15. At standard mounting.  
- Load (%) is percent of total allowable output power or each maximum output current, whichever is greater.  
For other mountings, refer to derating curve (A191-01-05\_).
- \*16. As for DENAN, designed to meet at 100VAC.
- \*17. Refer to test data(A191-58-01\_).

ZWQ130**SPECIFICATIONS (FORCED AIR COOLING)**

A191-01-02D

ITEMS	MODEL	ZWQ130-5223				ZWQ130-5225				
		V1	V2	V3	V4	V1	V2	V3	V4	
1	Nominal Output Voltage	V	+5	+12	-12	+3.3	+5	+12	-12	+5
2	Minimum Output Current (*1)	A	2.1	0	0	0	2.1	0	0	0
3	Maximum Output Current	A	19.0	5.0	5.0	12.0	19.0	5.0	5.0	12.0
4	Total Allowable Output Power (*2)	W	149.6				170			
5	Input Current (100/200VAC) (Typ) (*3)	A	2.6/1.3							
6	Operating Temperature (*4)	-	-10 ~ +70°C (-10 ~ +50°C : 100%, +70°C : 50%)							
7	Cooling (*5)	-	Forced Air Cooling							

\*Read instruction manual carefully, before using the power supply unit.

=NOTES=

\*For other items, refer to convection cooling specifications (A191-01-01\_).

\*1. For V2, V3, V4 stability, require minimum output current of V1.

When it is using under condition of forced air cooling, V1 minimum output current is same as convection cooling.

\*2. Allowable output power is changed according to V4 voltage, refer to derating table (A191-01-06\_).

\*3. At 100/200VAC, Ta=25C total allowable output power.

\*4. At standard mounting.

- Load (%) is percent of total allowable output power or each maximum output current, whichever is greater.

For other mountings, refer to derating curve (A191-01-06\_).

\*5. Air flow  $\geq 0.85\text{m}^3/\text{min}$ (30cfm)

SPECIFICATIONS (CONVECTION COOLING)

A191-01-03C

ITEMS	MODEL	ZWQ130-5222				ZWQ130-5224					
		V1	V2	V3	V4	V1	V2	V3	V4		
1	Nominal Output Voltage	V	+5	+12	-12	+12	+5	+12	-12	+24	
2	Minimum Output Current (Convection) (*1)	A	1.5	0	0	0	1.5	0	0	0	
3	Minimum Output Current (Peak Applicator) (*1)	A	2.1	0	0	0	2.1	0	0	0	
4	Maximum Output Current	A	15.0	4.0	4.0	4.0	15.0	4.0	4.0	2.0	
5	Total Allowable Output Power	W	130								
6	Maximum Peak Output Current (*2)	A	19.0	5.0	5.0	5.0	19.0	5.0	5.0	2.5	
7	Total Allowable Peak Output Power	W	170								
8	Efficiency (Typ) (*3)	%	72								
9	Input Voltage Range (*4)	-	85 - 265VAC (47 - 63Hz) or 120 - 370VDC								
10	Input Current (100/200VAC) (Typ) (*3)	A	2.0 / 1.0								
11	Inrush Current (Typ) (*5)	-	14A at 100VAC, 28A at 200VAC, Ta=25°C, Cold Start								
12	PFHC	-	Designed to meet IEC61000-3-2								
13	Power Factor (100/200VAC) (Typ) (*3)	-	0.99 / 0.93								
14	Output Voltage Range	V	5.0-5.25	+12/+15	-12/-15	11.4-12.6	5.0-5.25	+12/+15	-12/-15	22.8-25.2	
15	Output Voltage Accuracy	-	-	±5%	±5%	-	-	±5%	±5%	-	
16	Maximum Ripple & Noise (*6)	0°C ≤ Ta ≤ +60°C	mV	120	150	150	150	120	150	150	200
		-10°C ≤ Ta < 0°C	mV	160	180	180	180	160	180	180	200
17	Maximum Line Regulation (*6,7)	mV	20	48	48	48	20	48	48	96	
18	Maximum Load Regulation (*6,9)	mV	100	300	300	300	100	300	300	400	
19	Temperature Coefficient	-	Less than 0.02% / °C								
20	Over Current Protection (*9)	-	More than 173W of Total Output Power								
21	Over Voltage Protection (*10)	V	5.7 - 7.0	16.5 - 22.5	-22.5 - -16.5	13.8 - 16.2	5.7 - 7.0	16.5 - 22.5	-22.5 - -16.5	27.6 - 32.4	
22	Hold-Up Time (Typ) (*11)	-	20 ms								
23	Leakage Current (*12)	-	0.75mA MAX, 0.2mA(Typ) at 100VAC / 0.44mA(Typ) at 230VAC								
24	Remote ON/OFF Control (*13)	-	Possible								
25	Parallel Operation	-	-								
26	Series Operation	-	-								
27	Operating Temperature (*14)	-	-10 - +60 °C (-10 - +40 °C :100%, +60 °C :50%)								
28	Operating Humidity	-	30 - 90%RH (No Dewdrop)								
29	Storage Temperature	-	-30 - +85 °C								
30	Storage Humidity	-	10 - 95%RH (No Dewdrop)								
31	Cooling	-	Convection Cooling								
32	Withstand Voltage	-	Input - FG:2kVAC(20mA), Input - Output:3kVAC (20mA) Output - FG:500VAC(100mA), for 1min.								
33	Isolation Resistance	-	More than 100MW at 25 °C and 70%RH Output - FG:500VDC								
34	Vibration	-	At no operating, 10-55Hz (Sweep for 1min) 19.6 m/s <sup>2</sup> Constant, X, Y, Z, 1h each.								
35	Shock (In package)	-	Less than 196.1 m/s <sup>2</sup>								
36	Safety (*15)	-	Approved by UL60950-1, CSA C22.2 No.60950-1, EN60950-1. Designed to meet DENAN								
37	EMI	-	Designed to meet EN55011/EN55022-B, FCC-ClassB, VCCI-B								
38	Immunity (*16)	-	Designed to meet EN61000-4-2, -3, -4, -5, -6, -8, -11								
39	Weight (Typ)	-	730g								
40	Size (WxHxD)	mm	106 x 35 x 225 (Refer to Outline Drawing)								

\*Read instruction manual carefully, before using the power supply unit.

=NOTES=

- \*1. For V2, V3, V4 stability, require minimum output current of V1.
- \*2. Operating period at peak current is less than 10sec. (Duty≤0.35)
- \*3. At 100/200VAC, Ta=25°C and total allowable output power.
- \*4. For cases where conformance to various safety specs (UL, CSA, EN) are required, to be described as 100 - 240VAC(50/60Hz).
- \*5. Not applicable for the inrush current to Noise Filter for less than 0.2ms.
- \*6. Refer to output measuring (A191-01-07\_) for line & load regulation and ripple voltage.
- \*7. 85 - 265VAC, constant load.
- \*8. Minimum load - Full load, constant input voltage.
- \*9. Constant current limit with automatic recovery. Refer to test data (A191-53-01\_).  
Not operate at over load or dead short condition for more than 30 seconds.
- \*10. OVP circuit will shut down all outputs, manual reset (Line recycle).
- \*11. At 100/200VAC, nominal output voltage and total allowable output power.
- \*12. Measured by the each method of UL, CSA, EN and DENAN (at 60Hz), Ta=25°C.
- \*13. For using, refer to note (A191-01-07\_).
- \*14. At standard mounting.  
- Load (%) is percent of total allowable output power or each maximum output current, whichever is greater.  
For other mountings, refer to derating curve (A191-01-05\_).
- \*15. As for DENAN, designed to meet at 100VAC.
- \*16. Refer to test data(A191-58-01\_).

ZWQ130

**SPECIFICATIONS (FORCED AIR COOLING)**

A191-01-04C

ITEMS	MODEL	ZWQ130-5222				ZWQ130-5224				
		V1	V2	V3	V4	V1	V2	V3	V4	
1	Nominal Output Voltage	V	+5	+12	-12	+12	+5	+12	-12	+24
2	Minimum Output Current (*1)	A	2.1	0	0	0	2.1	0	0	0
3	Maximum Output Current	A	19.0	5.0	5.0	5.0	19.0	5.0	5.0	2.5
4	Total Allowable Output Power	W	170							
5	Input Current (100/200VAC) (Typ) (*2)	A	2.6 / 1.3							
6	Operating Temperature (*3)	-	-10 ~ +70°C (-10 ~ +50°C : 100%, +70°C : 50%)							
7	Cooling (*4)	-	Forced Air Cooling							

\*Read instruction manual carefully, before using the power supply unit.

=NOTES=

\*For other items, refer to convection cooling specifications (A191-01-01\_).

\*1. For V2, V3, V4 stability, require minimum output current of V1.

When it is using under condition of forced air cooling, V1 minimum output current is same as convection cooling.

\*2. At 100/200VAC, Ta=25°C total allowable output power.

\*3. At standard mounting.

- Load (%) is percent of total allowable output power or each maximum output current, whichever is greater.

For other mountings, refer to derating curve (A191-01-06\_).

\*4. Air flow  $\geq 0.85\text{m}^3/\text{min}$ (30cfm)

OUTPUT DERATING (CONVECTION COOLING)

A191-01-05

Ta(°C)	LOAD (%)		
	MOUNTING A	MOUNTING B,C,D	MOUNTING E
-10 ~+25	100	100	100
30	100	100	87
35	100	87	75
40	100	75	62
45	87	62	50
50	75	50	
55	62		
60	50		

Allowable output power

5225

A	B	C
5V	170W	130W
3V	146W	130W
2V	134W	130W

5223

A	B	C
3.3V	149.6W	130W
3V	146W	130W
2V	134W	130W

- A : V4 setting voltage
- B : Total Allowable Peak Output Power
- C : Total Allowable Output Power

\* The period of peak current at Convection Cooling is limited less than 10sec. (Duty  $\leq$  0.35)  
For peak current application, refer to note (A191-01-07\_).

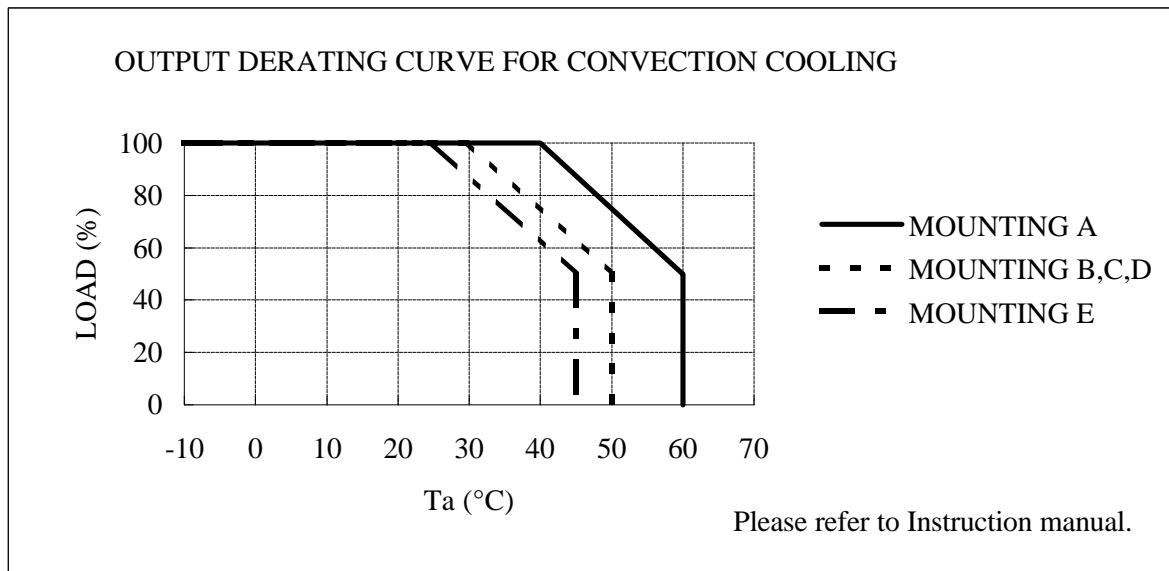

\* Load (%) is percent of total allowable output power or each maximum output current, whichever is greater.

MOUNTING A   
  MOUNTING B   
  MOUNTING C   
  MOUNTING D   
  MOUNTING E   
  PROHIBIT  
 (STANDARD MOUNTING)

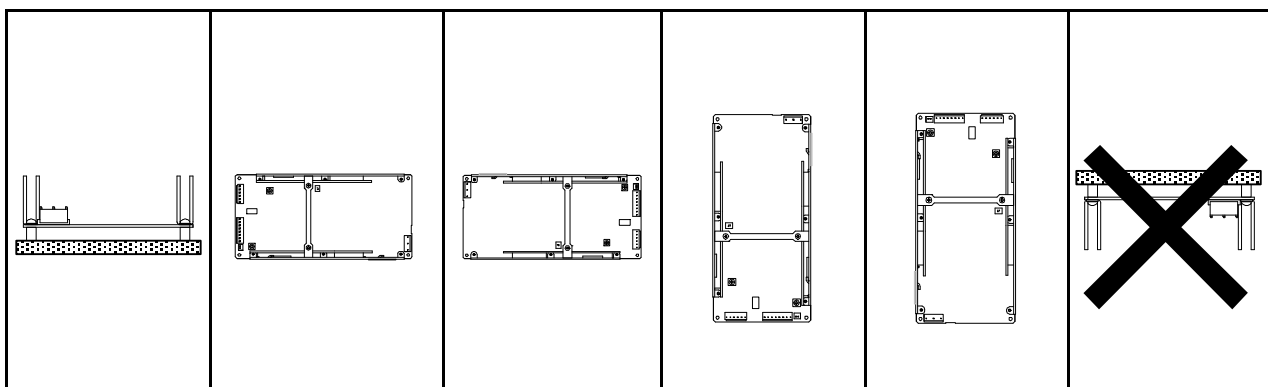

OUTPUT DERATING (FORCED AIR COOLING)

A191-01-06A

Ta(°C)	LOAD (%)
	MOUNTING A,B,C,D,E
-10 ~+40	100
45	100
50	100
55	87
60	75
65	62
70	50

Allowable output power

5225	
A	B
5V	170W
3V	146W
2V	134W

5223	
A	B
3.3V	149.6W
3V	146W
2V	134W

A : V4 setting voltage  
 B : Total Allowable Output Power

\* Air flow  $\leq 0.85\text{m}^3/\text{min}(30\text{cfm})$   
 Air must flow through component side.

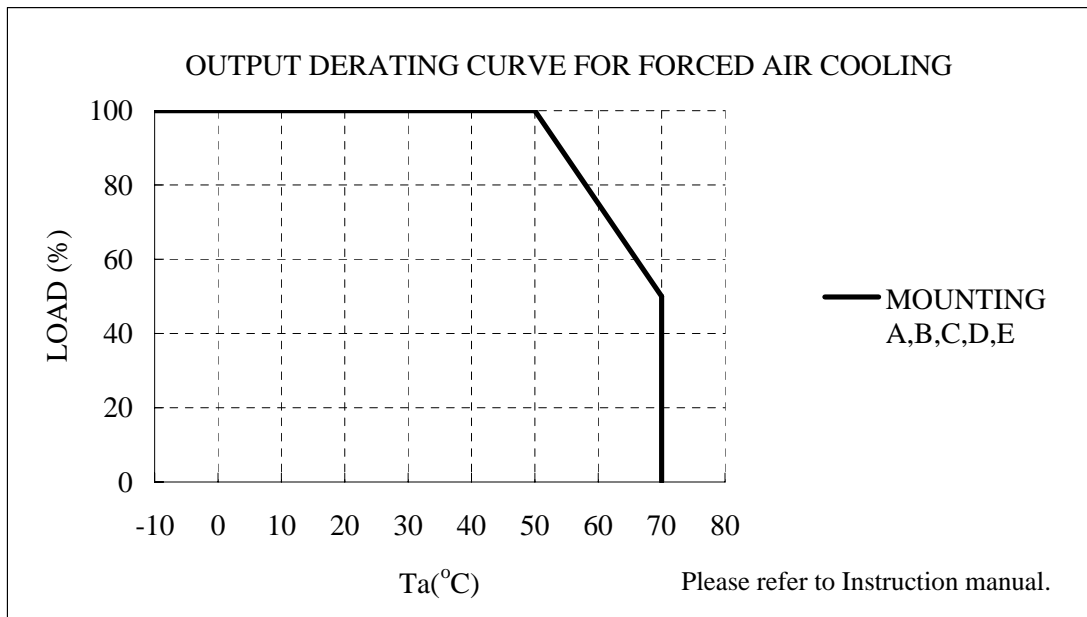

\* Load (%) is percent of total allowable output power or each maximum output current, whichever is greater.

MOUNTING A    MOUNTING B    MOUNTING C    MOUNTING D    MOUNTING E    PROHIBIT

(STANDARD MOUNTING)

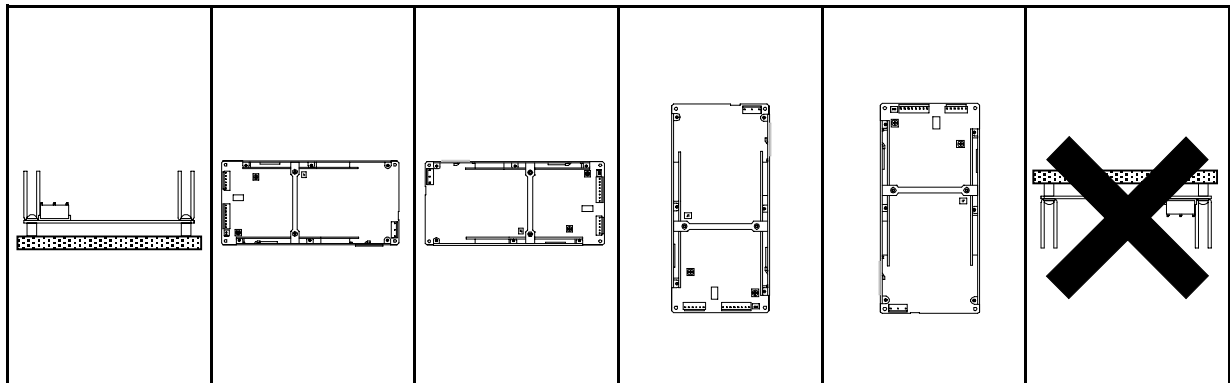

**Output Measuring**

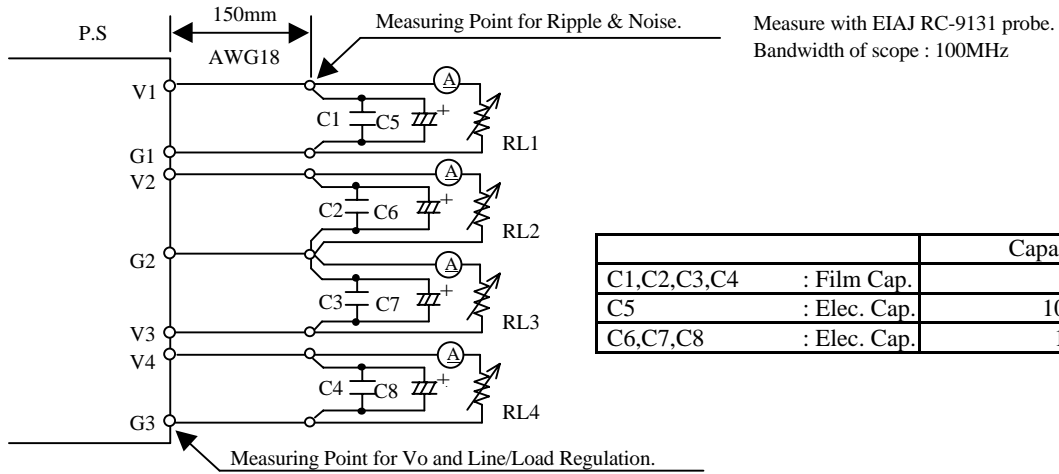

**Peak Output Current (Convection Cooling)**

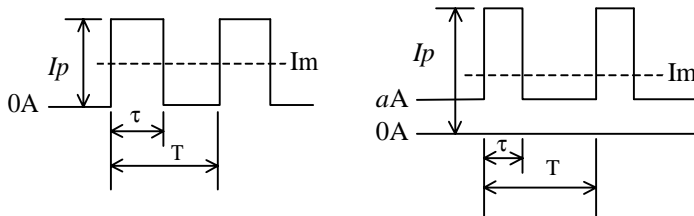

$I_p$  : Peak output current ( A )  
 $I_{av}$  : Average output current ( A )  
 ( Maximum output current (Convection) in Spec. )  
 $I_m$  : Average output current ( A )  
 $\tau$  : Pulse width of peak output current ( sec )  
 ( Operating time at peak output )  
 $T$  : Period ( sec ) : more than 10ms

$$I_{av} \geq I_m = \frac{I_p \times \tau}{T} \quad I_{av} \geq I_m = \frac{(I_p - a) \times \tau}{T} + a$$

\* The period of peak current at Convection Cooling is limited less than 10sec.. (Duty  $\leq$  0.35)  
 \* Take V1 minnum output current more than 2.1A.

**Remote ON/OFF Control**

Primary side

Terminal condition	Output
Connector(CN2) Short	ON
Connector(CN2) Open	OFF

A connector(CN2) for ON/OFF control is provided in the Primary Circuit. When using CN2, safety standard requirements should be considered in application design or choice of switch, relay or connector.

In particular:-

- (1) Basic insulation must be provided between the ON/OFF control circuit and earth.
- (2) Reinforced insulation must be provided between the ON/OFF control circuit and any secondary circuit or accessible part.
- (3) Wiring must be drawn to avoid damage to the insulation of the wire or sleeving.

Secondary side (Must be opened CN2)

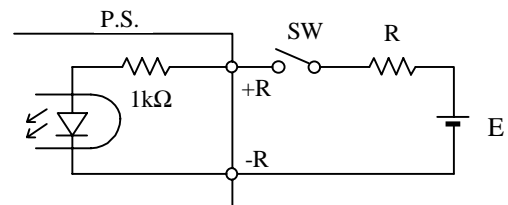

+R&-R terminal condition	Output
SW ON(Higher than 4.5V)	ON
SW OFF(Lower than 0.8V)	OFF

External voltage level : E	External resistance : R
4.5~12.5VDC	No required
12.5~24.5VDC	1.5kW