

ZWQ80

A190-01-01E

SPECIFICATIONS (CONVECTION COOLING)

ITEMS	MODEL		ZWQ80-5225				ZWQ80-5222				ZWQ80-5224				
			V1	V2	V3	V4	V1	V2	V3	V4	V1	V2	V3	V4	
1	Nominal Output Voltage	V	+5	+12	-12	+5	+5	+12	-12	+12	+5	+12	-12	+24	
2	Minimum Output Current (Convection) (*1)	A	0.9	0	0	0	0.9	0	0	0	0.9	0	0	0	
3	Minimum Output Current (Peak Application) (*1)	A	1.4	0	0	0	1.4	0	0	0	1.4	0	0	0	
4	Maximum Output Current	A	8.0	2.0	2.0	7.0	8.0	2.0	2.0	3.0	8.0	2.0	2.0	1.5	
5	Total Allowable Output Power (*16)	W	80				80				80				
6	Maximum Peak Output Current (*17)	A	10.0	2.5	2.5	9.0	10.0	2.5	2.5	4.0	10.0	2.5	2.5	2.0	
7	Total Allowable Peak Output Power (*16)	W	104				104				104				
8	Efficiency (Typ) (*2)	-	72%												
9	Input Voltage Range (*3)	-	85 - 265VAC (47 - 63Hz) or 120 - 370VDC												
10	Input Current (100/200VAC) (Typ) (*2)	A	1.2 / 0.6												
11	Inrush Current (Typ) (*4)	-	14A at 100VAC, 28A at 200VAC, Ta=25°C, Cold Start												
12	PFHC	-	Designed to meet IEC61000-3-2												
13	Power Factor (100/200VAC) (Typ) (*2)	-	0.99 / 0.93												
14	Output Voltage Range	V	5.0-5.25	+12/+15	-12/-15	2.0-5.25	5.0-5.25	+12/+15	-12/-15	11.4-12.6	5.0-5.25	+12/+15	-12/-15	22.8-25.2	
15	Output Voltage Accuracy	-	-	±5%	±5%	-	-	±5%	±5%	-	-	±5%	±5%	-	
16	Maximum Ripple & Noise (*5)	0 ≤ Ta ≤ +60°C	mV	120	150	150	120	120	150	150	150	120	150	150	200
		-10 ≤ Ta < 0°C	mV	160	180	180	160	160	180	180	180	160	180	180	200
17	Maximum Line Regulation (*5,6)	mV	20	48	48	20	20	48	48	48	20	48	48	96	
18	Maximum Load Regulation (*5,7)	mV	100	300	300	100	100	300	300	300	100	300	300	400	
19	Temperature Coefficient	-	Less than 0.02% / °C												
20	Over Current Protection (*8)	-	More than 109.2W of Total Output Power												
21	Over Voltage Protection (*9)	V	5.7 - 7.0	16.5-22.5	16.5-22.5	5.7 - 7.0	5.7 - 7.0	16.5-22.5	16.5-22.5	13.8-16.2	5.7 - 7.0	16.5-22.5	16.5-22.5	27.6-32.4	
22	Hold-Up Time (Typ) (*10)	-	20 ms												
23	Leakage Current (*11)	-	0.75mA MAX, 0.2mA(Typ) at 100VAC / 0.44mA(Typ) at 230VAC												
24	Remote ON/OFF Control (*14)	-	Possible												
25	Parallel Operation	-	-												
26	Series Operation	-	-												
27	Operating Temperature (*12)	-	-10 - +60°C (-10 - +40°C : 100%, +60°C : 50%)												
28	Operating Humidity	-	30 - 90%RH (No Dewdrop)												
29	Storage Temperature	-	-30 - +85°C												
30	Storage Humidity	-	10 - 95%RH (No Dewdrop)												
31	Cooling	-	Convection Cooling												
32	Withstand Voltage	-	Input - FG : 2kVAC(20mA), Input - Output : 3kVAC (20mA) Output - FG : 500VAC(100mA), for 1min.												
33	Isolation Resistance	-	More than 100MΩ at 25°C and 70%RH Output - FG : 500VDC												
34	Vibration	-	At no operating, 10-55Hz (Sweep for 1min) 19.6 m/s <sup>2</sup> Constant, X, Y, Z 1h each.												
35	Shock (In package)	-	Less than 196.1 m/s <sup>2</sup>												
36	Safety (*13)	-	Approved by UL60950-1, CSA C22.2 No.60950-1 & EN60950-1. Designed to meet DENAN												
37	EMI	-	Designed to meet EN55011/EN55022-B, FCC-ClassB, VCCI-B												
38	Immunity (*15)	-	Designed to meet EN61000-4-2, -3, -4, -5, -6, -8, -11												
39	Weight (Typ)	-	550g												
40	Size (W x H x D)	mm	93.5 x 35 x 210 (Refer to Outline Drawing)												

\*Read instruction manual carefully, before using the power supply unit.

=NOTES=

- \*1. For V2, V3, V4 stability, require minimum output current of V1.
- \*2. At 100/200VAC, Ta=25°C and total allowable output power.
- \*3. For cases where conformance to various safety specs (UL, CSA, EN) are required, to be described as 100 - 240VAC(50/60Hz).
- \*4. Not applicable for the inrush current to Noise Filter for less than 0.2ms.
- \*5. Refer to output measuring (A190-01-05\_) for line & load regulation and ripple voltage.
- \*6. 85 - 265VAC, constant load.
- \*7. Minimum load - Full load, constant input voltage.
- \*8. Constant current limit with automatic recovery. Refer to test data (A190-53-01\_).  
Not operate at over load or dead short condition for more than 30 seconds.
- \*9. OVP circuit will shut down all outputs, manual reset (Line recycle).
- \*10. At 100/200VAC, nominal output voltage and total allowable output power.
- \*11. Measured by the each method of UL, CSA, EN and DENAN (at 60Hz), Ta=25°C.
- \*12. At standard mounting.  
- Load (%) is percent of total allowable output power or each maximum output current, whichever is greater.  
For other mountings, refer to derating curve (A190-01-03\_).
- \*13. As for DENAN, designed to meet at 100VAC.
- \*14. For using, refer to note (A190-01-05\_).
- \*15. Refer to test data (A190-58-01\_).
- \*16. Allowable output power is changed according to V4 voltage(Only ZWQ-5225), refer to derating table(A190-01-03\_).
- \*17. Operating period at peak current is less than 10sec.. (Duty≤0.35)

ZWQ80

A190-01-02A

**SPECIFICATIONS (FORCED AIR COOLING)**

ITEMS	MODEL		ZWQ80-5225				ZWQ80-5222				ZWQ80-5224			
			V1	V2	V3	V4	V1	V2	V3	V4	V1	V2	V3	V4
1	Nominal Output Voltage	V	+5	+12	-12	+5	+5	+12	-12	+12	+5	+12	-12	+24
2	Minimum Output Current (*1)	A	1.4	0	0	0	1.4	0	0	0	1.4	0	0	0
3	Maximum Output Current	A	10.0	2.5	2.5	9.0	10.0	2.5	2.5	4.0	10.0	2.5	2.5	2.0
4	Total Allowable Output Power (*2)	W	104				104				104			
5	Input Current (100/200VAC) (Typ (*3))	A	1.6 / 0.8											
6	Operating Temperature (*4)	-	-10 ~ +70°C (-10 ~ +50°C : 100%, +70°C : 50%)											
7	Cooling (*5)	-	Forced Air Cooling											

\*Read instruction manual carefully, before using the power supply unit.

=NOTES=

\*For other items, refer to convection cooling specifications (A190-01-01\_).

\*1. For V2, V3, V4 stability, require minimum output current of V1.

When it is using under condition of forced air cooling, V1 minimum output current is same as convection cooling.

\*2. Allowable output power is changed according to V4 voltage(Only ZWQ-5225), refer to derating table (A190-01-04\_).

\*3. At 100/200VAC, Ta=25°C total allowable output power.

\*4. At standard mounting.

- Load (%) is percent of total allowable output power or each maximum output current, whichever is greater.

For other mountings, refer to derating curve (A190-01-04\_).

\*5. Air flow  $\geq 0.85\text{m}^3/\text{min}$ (30cfm)

OUTPUT DERATING (CONVECTION COOLING)

A190-01-03A

Allowable output power

Ta(°C)	LOAD (%)		
	MOUNT A	MOUNT B,C,D	MOUNT E
-10 ~ +25	100	100	100
30	100	100	100
35	100	100	87
40	100	87	75
45	87	75	62
50	75	62	50
55	62	50	
60	50		

5225		
A	B	C
5V	104W	80W
3V	86W	80W
2V	77W	77W

5223		
A	B	C
3.3V	88.7W	80W
3V	86W	80W
2V	77W	77W

A : V4 setting voltage  
 B : Total Allowable Peak Output Power  
 C : Total Allowable Output Power

\* The period of peak current at Convection Cooling is limited less than 10sec.. (Duty ≤ 0.35)  
 For peak current application, refer to note (A190-01-05\_).

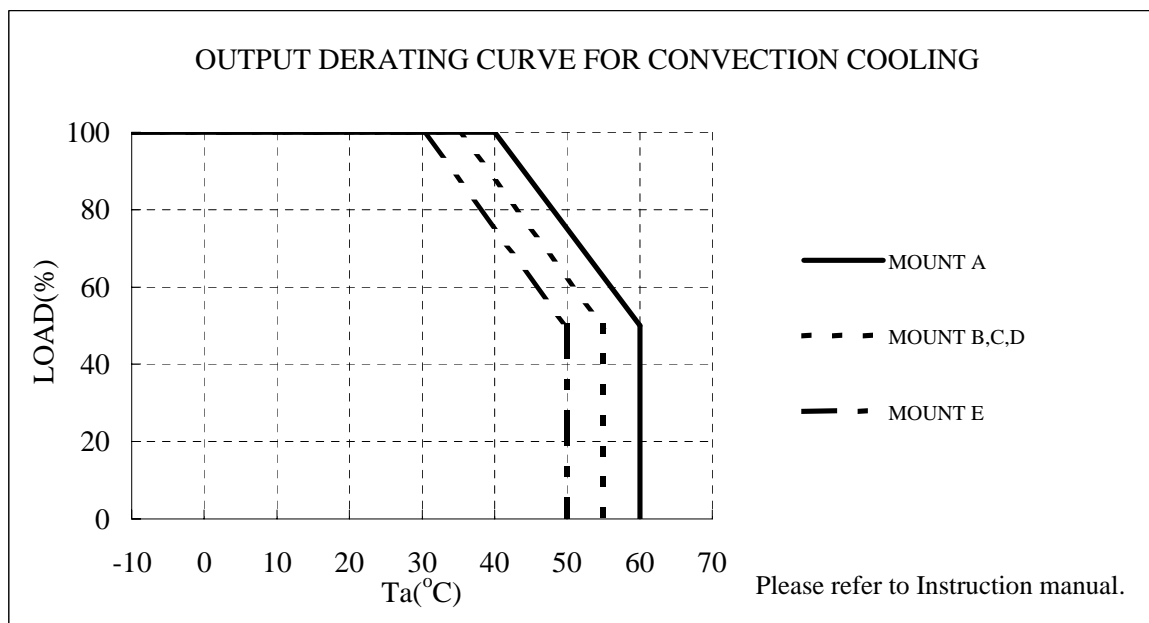

\* Load (%) is percent of total allowable output power or each maximum output current, whichever is greater.

- MOUNTING A
- MOUNTING B
- MOUNTING C
- MOUNTING D
- MOUNTING E
- PROHIBIT

(STANDARD MOUNTING)

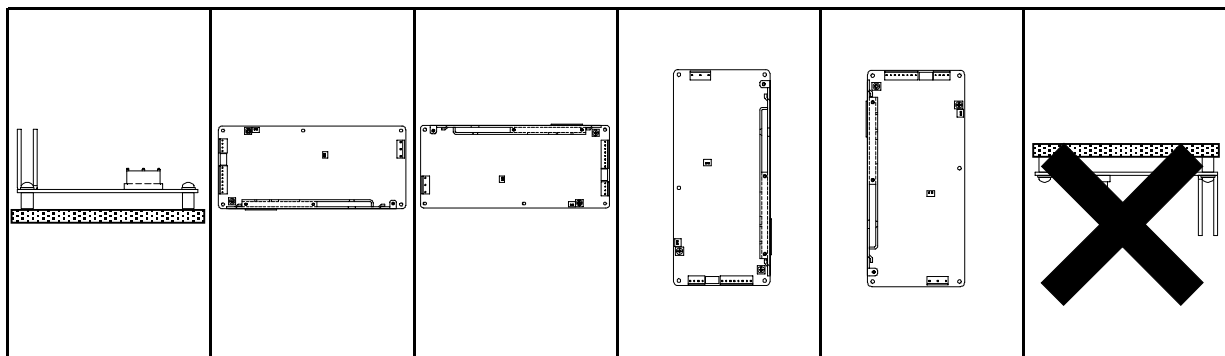

OUTPUT DERATING (FORCED AIR COOLING)

A190-01-04A

Allowable output power

Ta(°C)	LOAD (%)
	MOUNT A,B,C,D,E
-10 ~ +40	100
45	100
50	100
55	87
60	75
65	62
70	50

5225	
A	B
5V	104W
3V	86W
2V	77W

5223	
A	B
3.3V	88.7W
3V	86W
2V	77W

A : V4 setting voltage  
 B : Total Allowable Output Power

\* Air flow  $\geq 0.85\text{m}^3/\text{min}(30\text{cfm})$   
 Air must flow through component side.

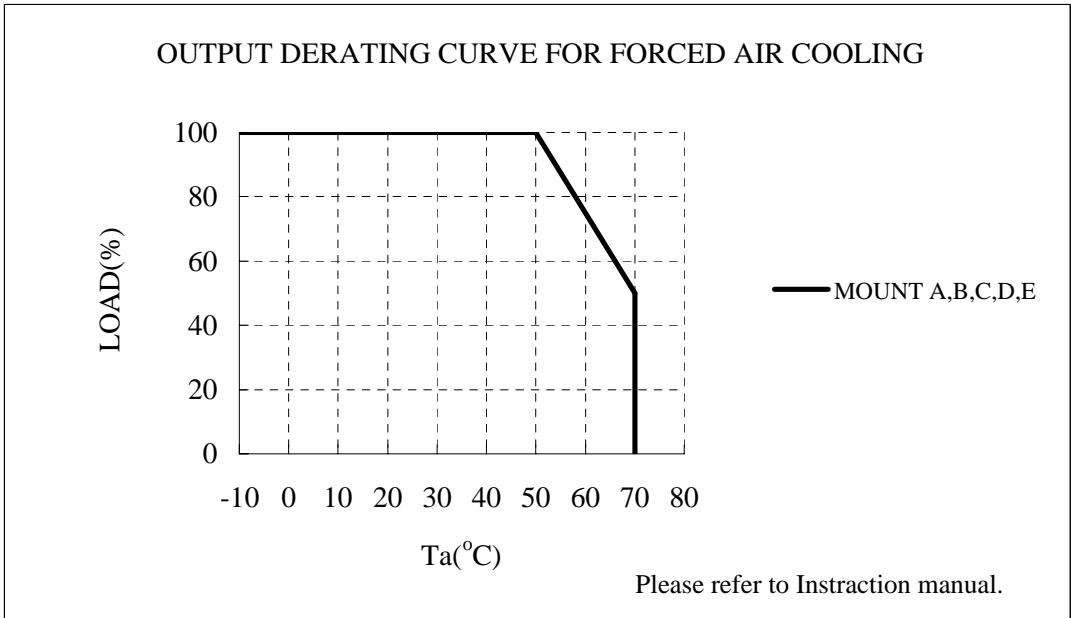

\* Load (%) is percent of total allowable output power or each maximum output current, whichever is greater.

MOUNTING A    MOUNTING B    MOUNTING C    MOUNTING D    MOUNTING E    PROHIBIT

(STANDARD)

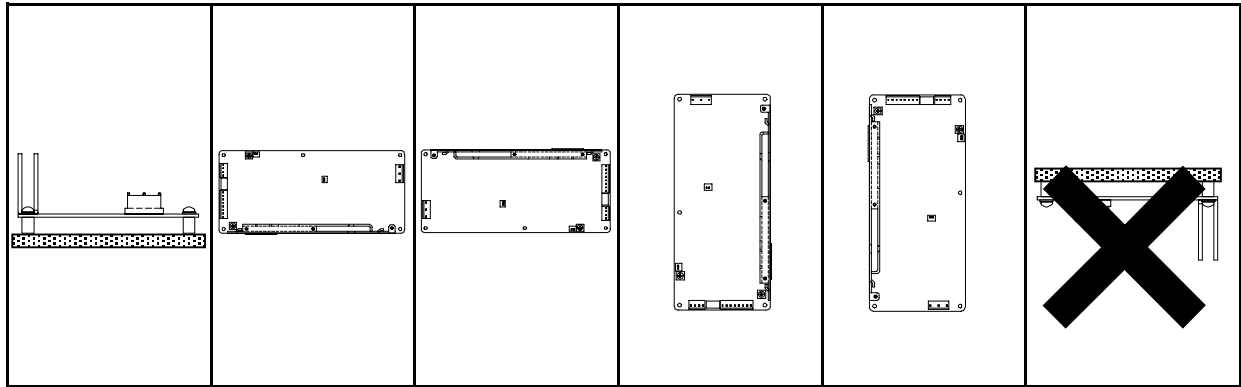

NOTE

A190-01-05

Output Measuring

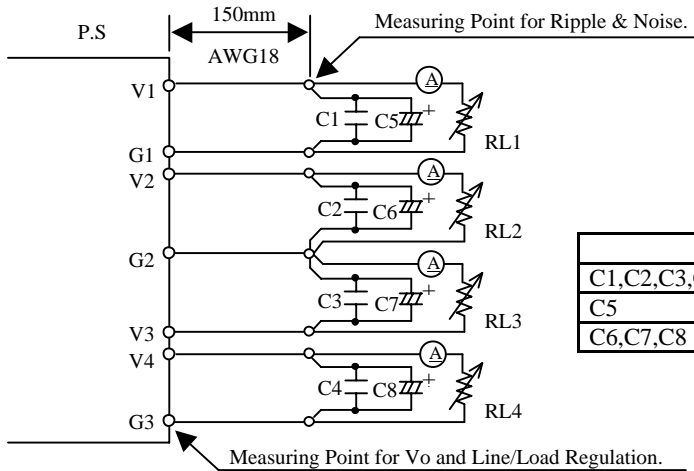

Measure with EIAJ RC-9131 probe.  
Bandwidth of scope : 100MHz

		Capacitance
C1,C2,C3,C4	: Film Cap.	0.1 μF
C5	: Elec. Cap.	1000 μF
C6,C7,C8	: Elec. Cap.	100 μF

Peak Output Current (Convection Cooling)

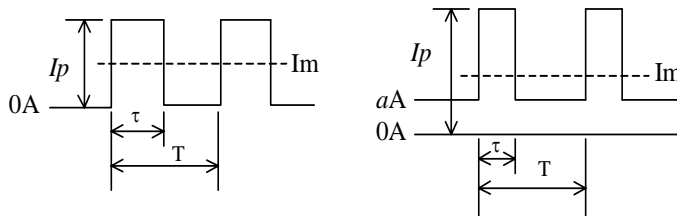

Ip : Peak output current ( A )  
Iav : Average output current ( A )  
( Maximum output current (Convection) in Spec. )  
Im : Average output current ( A )  
τ : Pulse width of peak output current ( sec )  
( Operating time at peak output )  
T : Period ( sec ) : more than 10ms

$$I_{av} \geq I_m = \frac{I_p \times \tau}{T}$$

$$I_{av} \geq I_m = \frac{(I_p - a) \times \tau}{T} + a$$

\* The period of peak current at Convection Cooling is limited less than 10sec.. (Duty ≤ 0.35)  
\* Take V1 minimum output current more than 1.4A.

Remote ON/OFF Control

Primary side

Terminal condition	Output
Connector(CN2) Short	ON
Connector(CN2) Open	OFF

A connector(CN2) for ON/OFF control is provided in the Primary Circuit. When using CN2, safety standard requirements should be considered in application design or choice of switch, relay or connector.

In particular:-

- (1) Basic insulation must be provided between the ON/OFF control circuit and earth.
- (2) Reinforced insulation must be provided between the ON/OFF control circuit and any secondary circuit or accessible part.
- (3) Wiring must be drawn to avoid damage to the insulation of the wire or sleeving.

Secondary side (Must be opened CN2)

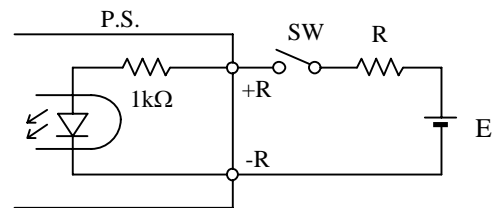

+R&-R terminal condition	Output
SW ON(Higher than 4.5V)	ON
SW OFF(Lower than 0.8V)	OFF

External voltage level : E	External resistance : R
4.5~12.5VDC	No required
12.5~24.5VDC	1.5kΩ

**ZWQ80**

A190-01-06D

**SPECIFICATIONS (CONVECTION COOLING)**

ITEMS	MODEL	ZWQ80-5223					
		V1	V2	V3	V4		
1	Nominal Output Voltage	V	+5	+12	-12	+3.3	
2	Minimum Output Current (Convection) (*1)	A	0.9	0	0	0	
3	Minimum Output Current (Peak Application) (*1)	A	1.4	0	0	0	
4	Maximum Output Current	A	8.0	2.0	2.0	7.0	
5	Total Allowable Output Power (*16)	W	80				
6	Maximum Peak Output Current (*17)	A	10.0	2.5	2.5	9.0	
7	Total Allowable Peak Output Power (*16)	-	88.7W				
8	Efficiency (Typ) (*2)	-	72%				
9	Input Voltage Range (*3)	-	85 - 265VAC (47 - 63Hz) or 120 - 370VDC				
10	Input Current (100/200VAC) (Typ) (*2)	A	1.2 / 0.6				
11	Inrush Current (Typ) (*4)	-	14A at 100VAC, 28A at 200VAC, Ta=25°C, Cold Start				
12	PFHC	-	Designed to meet IEC61000-3-2				
13	Power Factor (100/200VAC) (Typ) (*2)	-	0.99 / 0.93				
14	Output Voltage Range	V	5.0-5.25	+12/+15	-12/-15	2.0-3.63	
15	Output Voltage Accuracy	-	-	±5%	±5%	-	
16	Maximum Ripple & Noise (*5)	0 ≤ Ta ≤ +60°C	mV	120	150	150	120
		-10 ≤ Ta < 0°C	mV	160	180	180	160
17	Maximum Line Regulation (*5,6)	mV	20	48	48	20	
18	Maximum Load Regulation (*5,7)	mV	100	300	300	100	
19	Temperature Coefficient	-	Less than 0.02%/°C				
20	Over Current Protection (*8)	-	More than 93.1W of Total Output Power				
21	Over Voltage Protection (*9)	V	5.7 - 7.0	16.5-22.5	16.5-22.5	3.79 - 4.95	
22	Hold-Up Time (Typ) (*10)	-	20 ms				
23	Leakage Current (*11)	-	0.75mA MAX,0.2mA(Typ) at 100VAC / 0.44mA(Typ) at 230VAC				
24	Remote ON/OFF Control (*14)	-	Possible				
25	Parallel Operation	-	-				
26	Series Operation	-	-				
27	Operating Temperature (*12)	-	-10 - +60°C (-10 - +40°C : 100%, +60°C : 50%)				
28	Operating Humidity	-	30 - 90%RH (No Dewdrop)				
29	Storage Temperature	-	-30 - +85°C				
30	Storage Humidity	-	10 - 95%RH (No Dewdrop)				
31	Cooling	-	Convection Cooling				
32	Withstand Voltage	-	Input - FG : 2kVAC(20mA), Input - Output : 3kVAC (20mA) Output - FG : 500VAC(100mA), for 1min.				
33	Isolation Resistance	-	More than 100MΩ at 25°C and 70%RH Output - FG : 500VDC				
34	Vibration	-	At no operating, 10-55Hz (Sweep for 1min) 19.6 m/s <sup>2</sup> Constant, X, Y, Z 1h each.				
35	Shock (In package)	-	Less than 196.1 m/s <sup>2</sup>				
36	Safety (*13)	-	Approved by UL60950-1, CSA C22.2 No.60950-1 & EN60950-1. Designed to meet DENAN				
37	EMI	-	EN55011/EN55022-B, FCC-ClassB, VCCI-B				
38	Immunity (*15)	-	Designed to meet EN61000-4-2, -3, -4, -5, -6, -8, -11				
39	Weight (Typ)	-	550g				
40	Size (W x H x D)	mm	93.5 x 35 x 210 (Refer to Outline Drawing)				

\*Read instruction manual carefully, before using the power supply unit.

=NOTES=

- \*1. For V2, V3, V4 stability, require minimum output current of V1.
- \*2. At 100/200VAC, Ta=25°C and total allowable output power.
- \*3. For cases where conformance to various safety specs (UL, CSA, EN) are required, to be described as 100 - 240VAC(50/60Hz).
- \*4. Not applicable for the inrush current to Noise Filter for less than 0.2ms.
- \*5. Refer to output measuring (A190-01-05\_) for line & load regulation and ripple voltage.
- \*6. 85 - 265VAC, constant load.
- \*7. Minimum load - Full load, constant input voltage.
- \*8. Constant current limit with automatic recovery. Refer to test data (A190-53-01\_).  
Not operate at over load or dead short condition for more than 30 seconds.
- \*9. OVP circuit will shut down all outputs, manual reset (Line recycle).
- \*10. At 100/200VAC, nominal output voltage and total allowable output power.
- \*11. Measured by the each method of UL, CSA, EN and DENAN (at 60Hz), Ta=25°C.
- \*12. At standard mounting.  
- Load (%) is percent of total allowable output power or each maximum output current, whichever is greater.  
For other mountings, refer to derating curve (A190-01-03\_).
- \*13. As for DENAN, designed to meet at 100VAC.
- \*14. For using, refer to note (A190-01-05\_).
- \*15. Refer to test data (A190-58-01\_).
- \*16. Allowable output power is changed according to V4 voltage, refer to derating table (A190-01-03\_).
- \*17. Operating period at peak current is less than 10sec.. (Duty≤0.35)

**ZWQ80**

A190-01-07A

**SPECIFICATIONS (FORCED AIR COOLING)**

MODEL		ZWQ80-5223				
		V1	V2	V3	V4	
1	Nominal Output Voltage	V	+5	+12	-12	+3.3
2	Minimum Output Current (*1)	A	1.4	0	0	0
3	Maximum Output Current	A	10.0	2.5	2.5	9.0
4	Total Allowable Output Power (*2)	W	88.7			
5	Input Current (100/200VAC) (Typ (*3)	A	1.6 / 0.8			
6	Operating Temperature (*4)	-	-10 ~ +70°C (-10 ~ +50°C : 100%, +70°C : 50%)			
7	Cooling (*5)	-	Forced Air Cooling			

\*Read instruction manual carefully, before using the power supply unit.

=NOTES=

\*For other items, refer to convection cooling specifications (A190-01-01\_).

\*1. For V2, V3, V4 stability, require minimum output current of V1.

When it is using under condition of forced air cooling, V1 minimum output current is same as convection cooling.

\*2. Allowable output power is changed according to V4 voltage, refer to derating table (A190-01-04\_).

\*3. At 100/200VAC, Ta=25°C total allowable output power.

\*4. At standard mounting.

- Load (%) is percent of total allowable output power or each maximum output current, whichever is greater.

For other mountings, refer to derating curve (A190-01-04\_).

\*5. Air flow  $\geq 0.85\text{m}^3/\text{min}$ (30cfm)