

C1005X8R2A331M050BA

TDK Item Description : C1005X8R2A331MT****



Application & Main Feature

Commercial Grade (High Temperature Application)

Series

C1005 [EIA 0402]

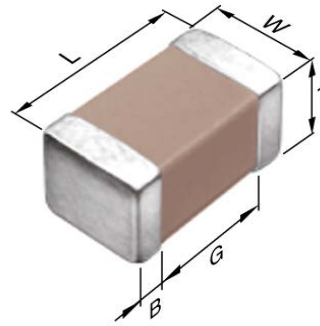

Dimensions

L	1.00mm +/-0.05mm
W	0.50mm +/-0.05mm
T	0.50mm +/-0.05mm
B	0.10mm Min.
G	0.30mm Min.

Temperature Characteristic

X8R (-55 to 150 degC +/-15%)

Rated Voltage

2A (100Vdc)

Capacitance

330pF

Capacitance Tolerance

M (+/-20%)

Dissipation Factor

3% Max.

Insulation Resistance

10Gohm Min

AEC-Q200

Not Applicable

|Z|, ESR vs. Freq. Characteristics

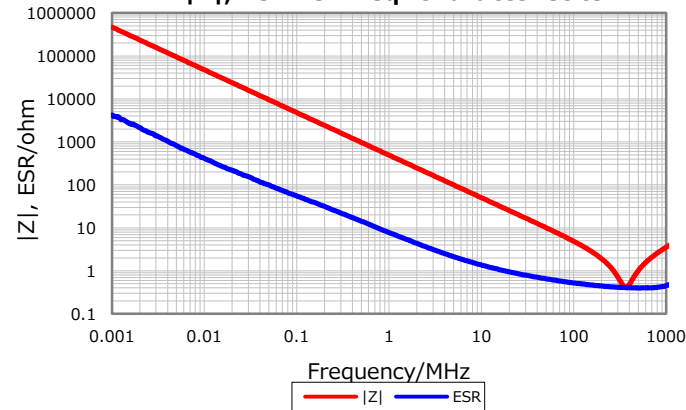

Cap. vs. Freq. Characteristic

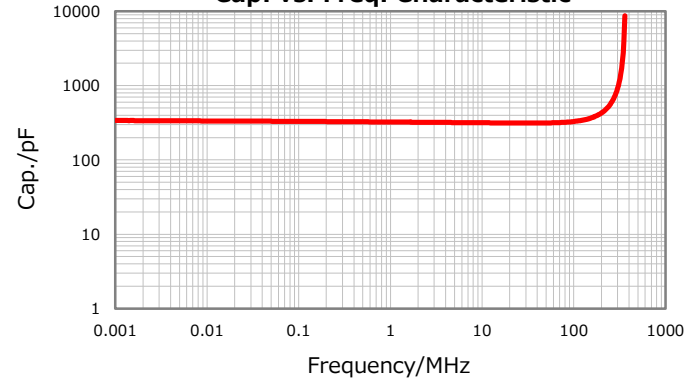

DC Bias Characteristic

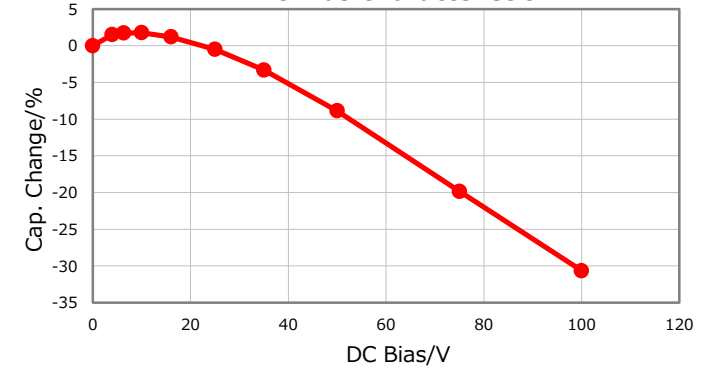

Temperature Characteristics

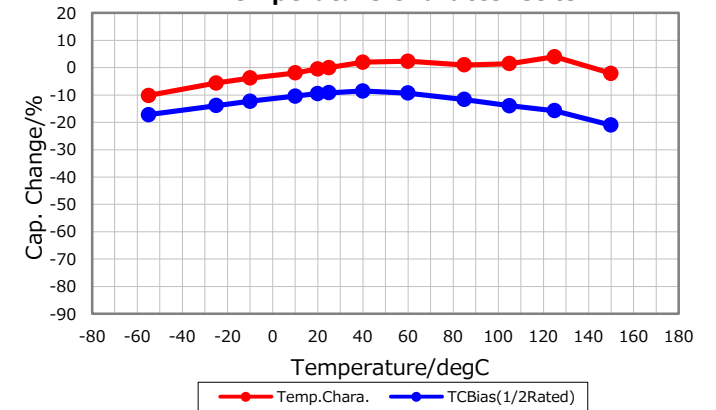

Ripple Temperature Rise Characteristics

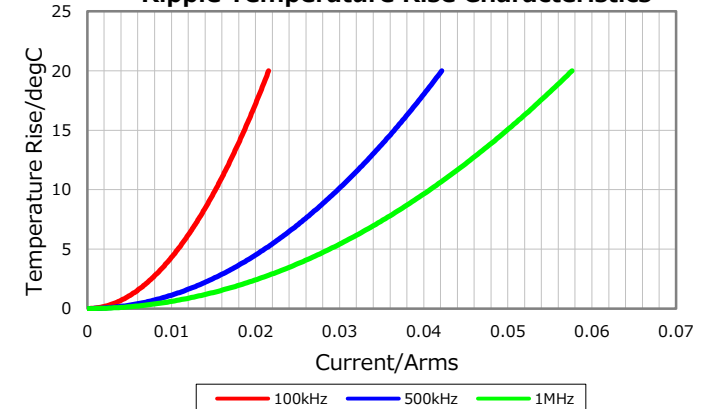

Characterization Sheet (Multilayer Ceramic Chip Capacitors)



All specifications are subject to change without notice.

July 6, 2016