

C1608C0G1H152J080AA

TDK Item Description : C1608C0G1H152JT****



Application & Main Feature

Commercial Grade(Up to 50V)

Series

C1608 [EIA 0603]

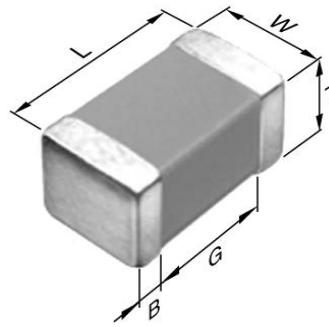

Dimensions

L	1.60mm ±0.10mm
W	0.80mm ±0.10mm
T	0.80mm ±0.10mm
B	0.20mm Min.
G	0.30mm Min.

Temperature Characteristic

C0G (-55 to 125 degC 0+/-30ppm/degC)

Rated Voltage

1H(50Vdc)

Capacitance

1.5nF

Capacitance Tolerance

J (±5%)

Q Factor

1000 Min.

Insulation Resistance

10Gohm Min

AEC-Q200

Not Applicable

|Z|, ESR vs. Freq. Characteristics

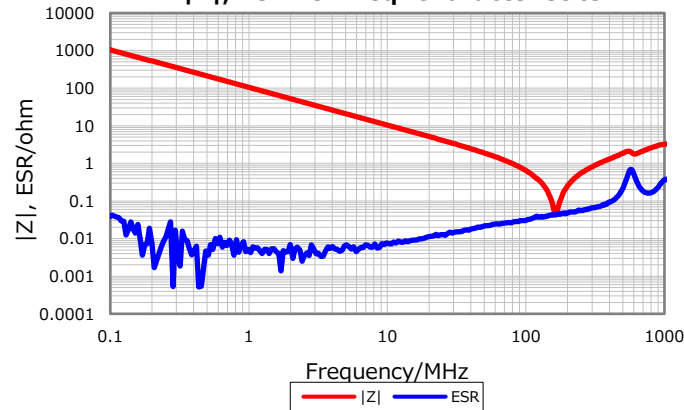

Cap. vs. Freq. Characteristic

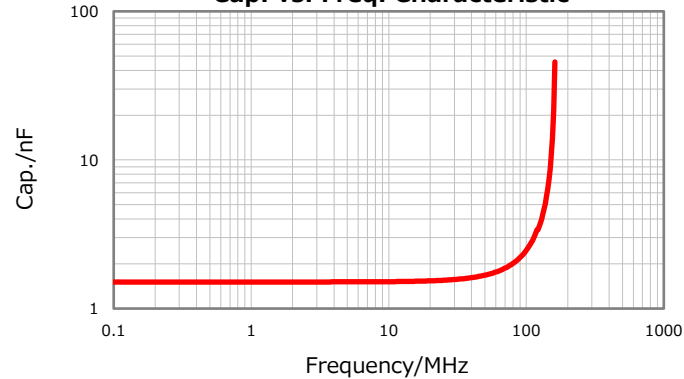

DC Bias Characteristic

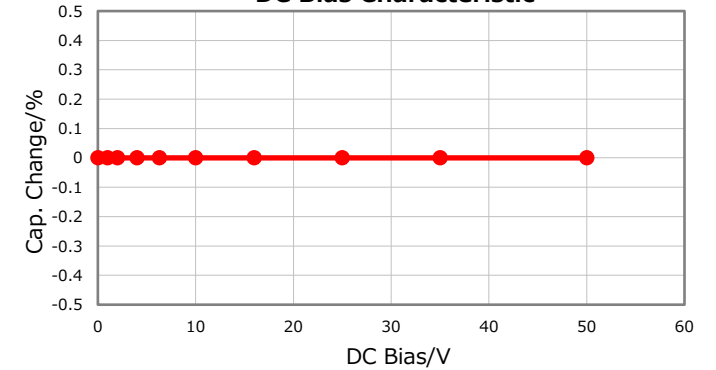

Temperature Characteristics

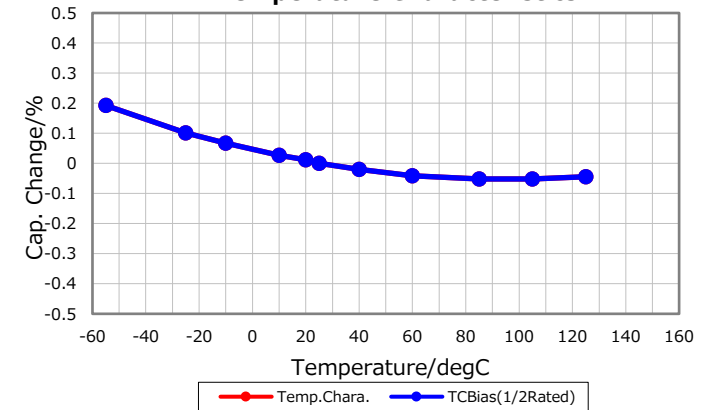

Ripple Temperature Rise Characteristics

