

C1608C0G2A103K080AC

TDK Item Description : C1608C0G2A103KT****



Application & Main Feature

Commercial Grade (Mid Volatage (100 to 630V))

Series

C1608 [EIA 0603]

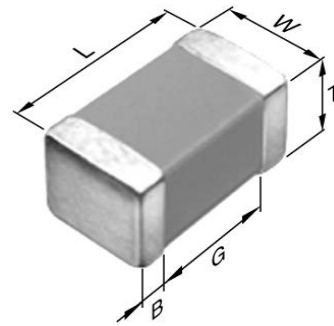

Dimensions

L	1.60mm +/-0.1mm
W	0.80mm +/-0.1mm
T	0.80mm +/-0.1mm
B	0.20mm Min.
G	0.30mm Min.

Temperature Characteristic

C0G (-55 to 125 degC 0+/-30ppm/degC)

Rated Voltage

2A (100Vdc)

Capacitance

10nF

Capacitance Tolerance

K (+/-10%)

Q Factor

1000 Min.

Insulation Resistance

10Gohm Min

AEC-Q200

Not Applicable

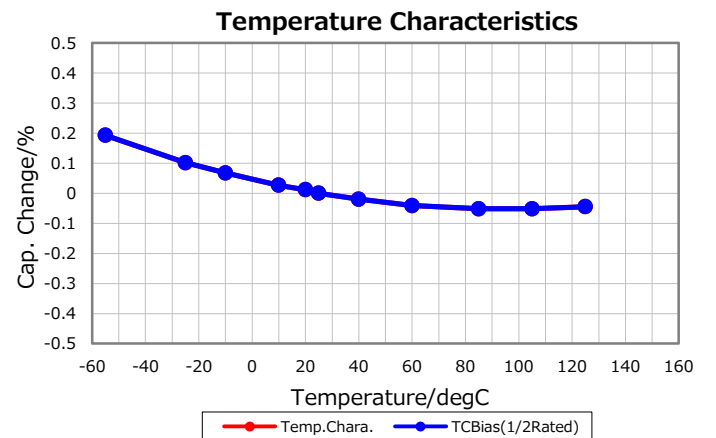
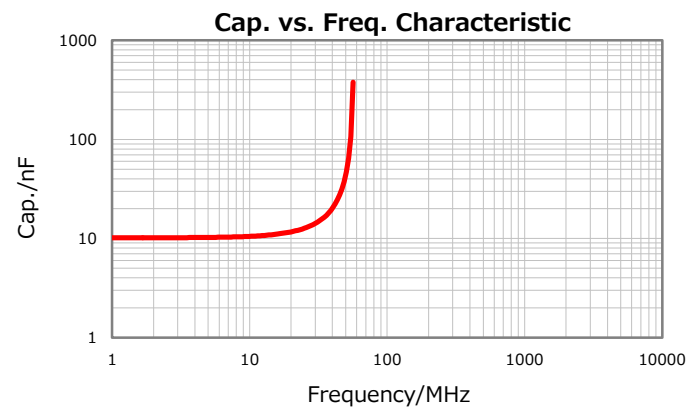
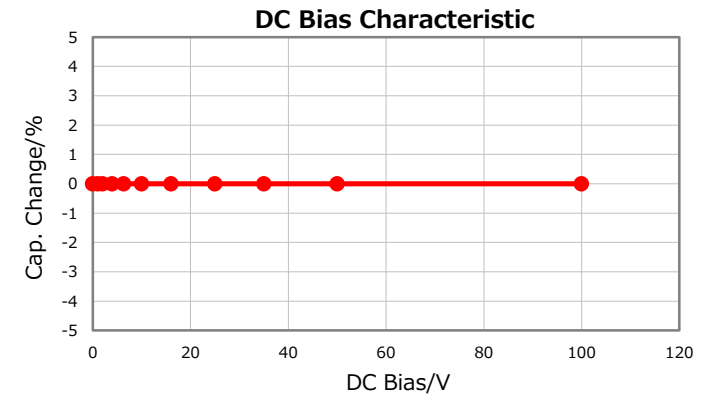
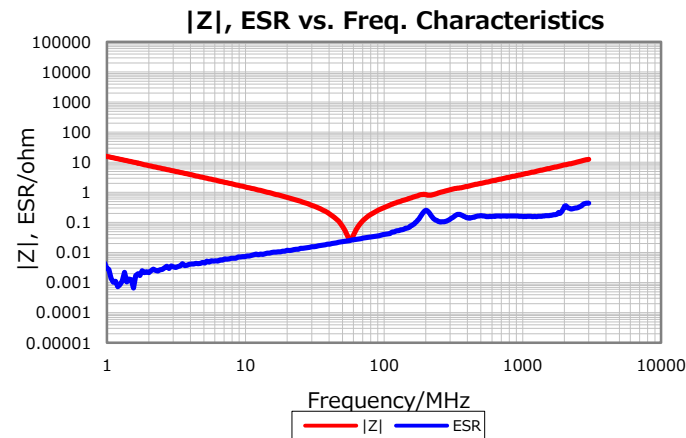

Characterization Sheet (Multilayer Ceramic Chip Capacitors)



All specifications are subject to change without notice.

July 6, 2016