

C1608X5R0G226M080AA

TDK Item Description : C1608X5R0G226MT****



Application & Main Feature

Commercial Grade (General (Up to 50V))

Series

C1608 [EIA CC0603]

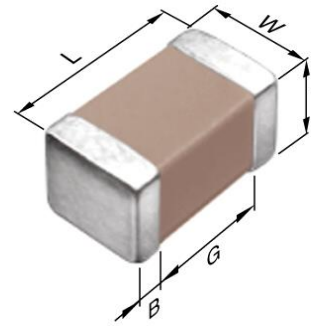

Dimensions

L 1.60±0.20
 W 0.80±0.20
 T 0.80±0.20
 B 0.20mm Min.
 G 0.30mm Min.

Temperature Characteristic

X5R (-55 to 85 degC +/-15%)

Rated Voltage

0G (4Vdc)

Capacitance

22uF

Capacitance Tolerance

M (+/-20%)

Dissipation Factor

10% Max.

Insulation Resistance

4Mohm Min.

AEC-Q200

Not Applicable

