

C1608X5R1V224K080AB

TDK Item Description : C1608X5R1V224KT****



Application & Main Feature

Commercial Grade (General (Up to 50V))

Series

C1608 [EIA 0603]

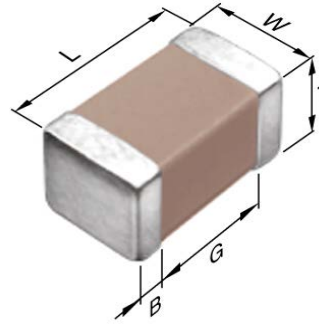

Dimensions

L	1.60mm +/-0.1mm
W	0.80mm +/-0.1mm
T	0.80mm +/-0.1mm
B	0.20mm Min.
G	0.30mm Min.

Temperature Characteristic

X5R (-55 to 85 degC +/-15%)

Rated Voltage

1V (35Vdc)

Capacitance

220nF

Capacitance Tolerance

K (+/-10%)

Dissipation Factor

5% Max.

Insulation Resistance

2.272Gohm Min

AEC-Q200

Not Applicable

|Z|, ESR vs. Freq. Characteristics

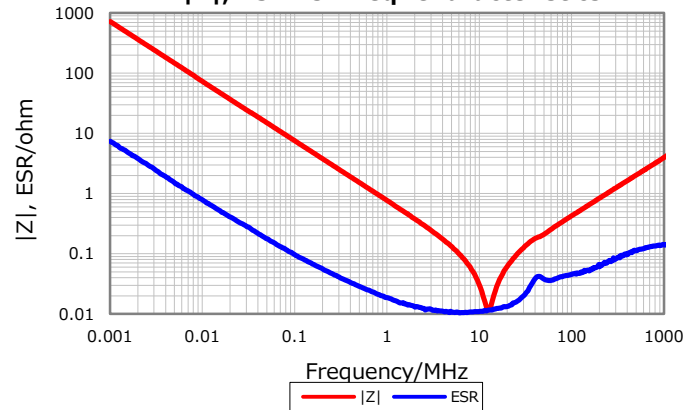

Cap. vs. Freq. Characteristic

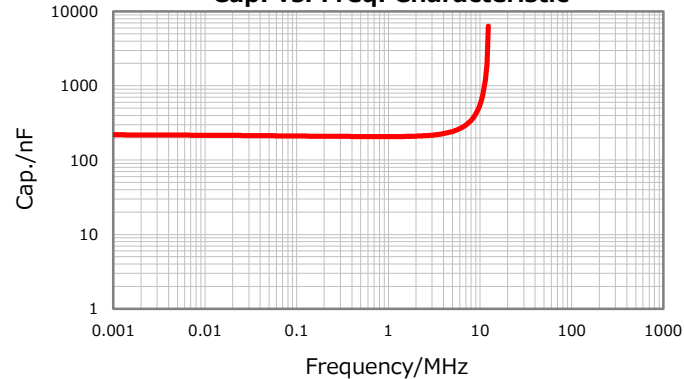

DC Bias Characteristic

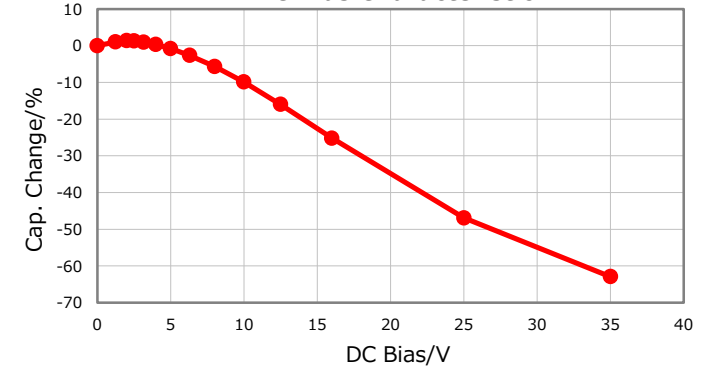

Temperature Characteristics

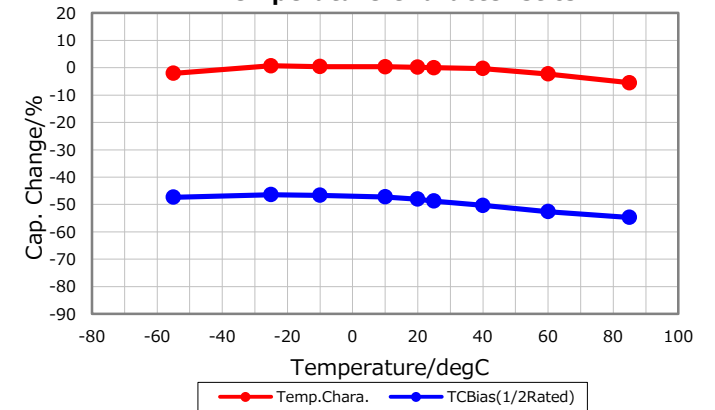

Ripple Temperature Rise Characteristics

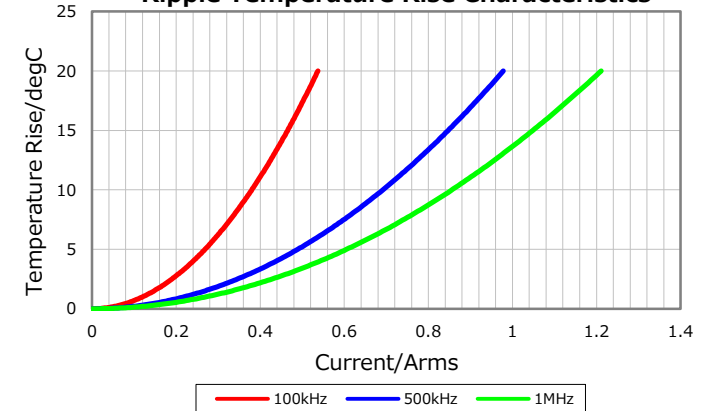

Characterization Sheet (Multilayer Ceramic Chip Capacitors)



All specifications are subject to change without notice.

June 29, 2017