

C1608X7R2A103K080AE

TDK Item Description : C1608X7R2A103KT***S



Application & Main Feature

Commercial Grade (Soft Termination)

Series

C1608 [EIA CC0603]

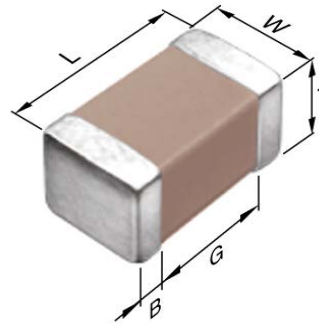

Dimensions

L	1.60mm +0.2,-0.1mm
W	0.80mm +0.15,-0.1mm
T	0.80mm +0.15,-0.1mm
B	0.20mm Min.
G	0.30mm Min.

Temperature Characteristic

X7R (-55 to 125 degC +/-15%)

Rated Voltage

2A (100Vdc)

Capacitance

10nF

Capacitance Tolerance

K (+/-10%)

Dissipation Factor

3% Max.

Insulation Resistance

10Gohm Min

AEC-Q200

Not Applicable

|Z|, ESR vs. Freq. Characteristics (Simulation Data)

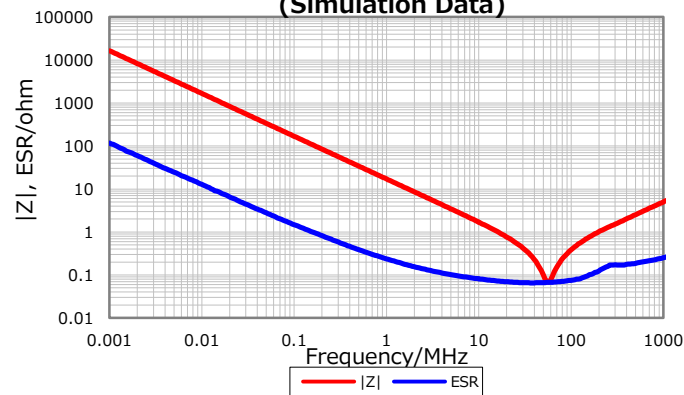

Cap. vs. Freq. Characteristic

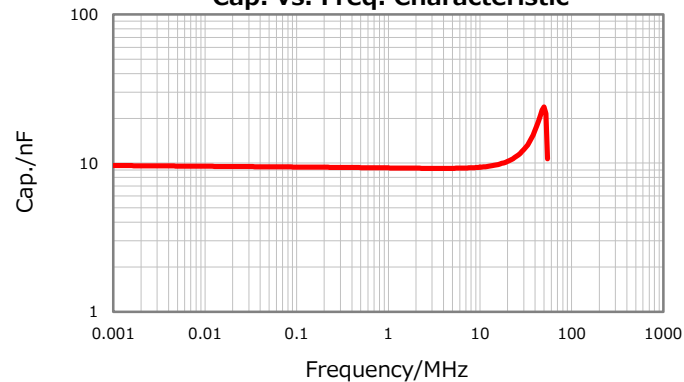

DC Bias Characteristic

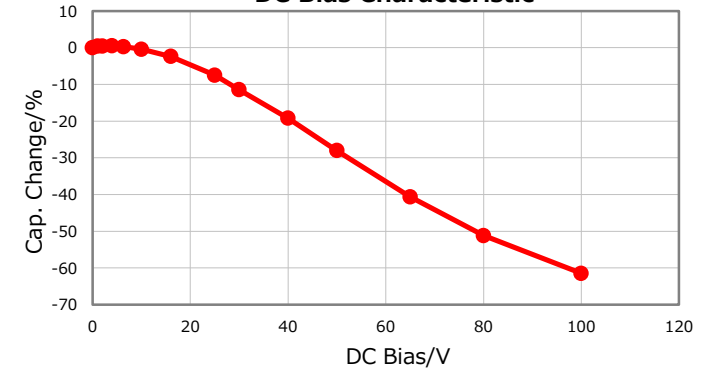

Temperature Characteristics

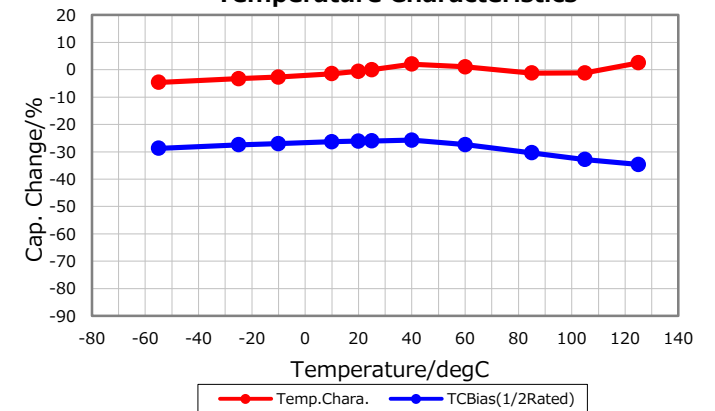

Ripple Temperature Rise Characteristics

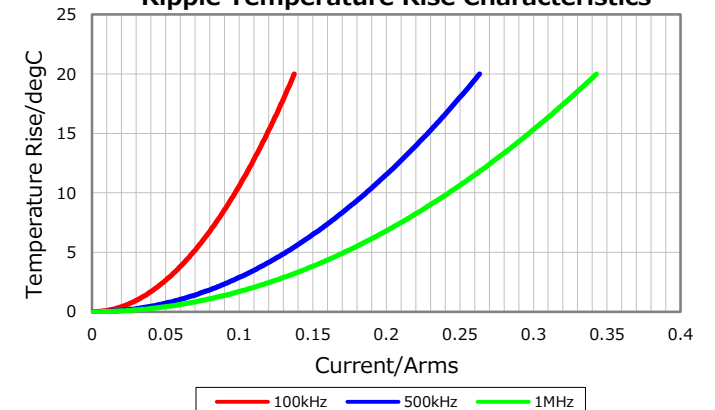

Characterization Sheet (Multilayer Ceramic Chip Capacitors)



All specifications are subject to change without notice.

March 16, 2017