

Application & Main Feature

Commercial Grade (Mid Volatage (100 to 630V))

Series

C2012 [EIA 0805]

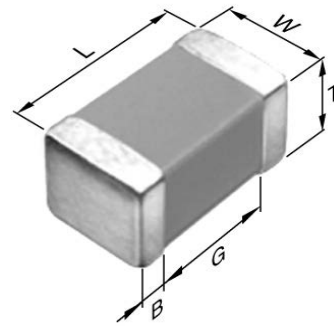

Dimensions

L	2.00mm +/-0.2mm
W	1.25mm +/-0.2mm
T	1.25mm +/-0.2mm
B	0.20mm Min.
G	0.50mm Min.

Temperature Characteristic

CH (-55 to 85 degC 0+/-60ppm/degC)

Rated Voltage

2A (100Vdc)

Capacitance

22nF

Capacitance Tolerance

K (+/-10%)

Q Factor

1000 Min.

Insulation Resistance

10Gohm Min

AEC-Q200

Not Applicable

