

C2012X5R1C226M125AC

TDK Item Description : C2012X5R1C226MT****



Application & Main Feature

Commercial Grade (General (Up to 75V))

Series

C2012 [EIA CC0805]

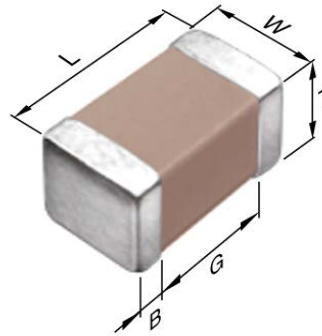

Dimensions

L	2.00mm +/-0.2mm
W	1.25mm +/-0.2mm
T	1.25mm +/-0.2mm
B	0.20mm Min.
G	0.50mm Min.

Temperature Characteristic

X5R (-55 to 85 degC +/-15%)

Rated Voltage

1C (16Vdc)

Capacitance

22uF

Capacitance Tolerance

M (+/-20%)

Dissipation Factor

10% Max.

Insulation Resistance

4Mohm Min.

AEC-Q200

Not Applicable

|Z|, ESR vs. Freq. Characteristics

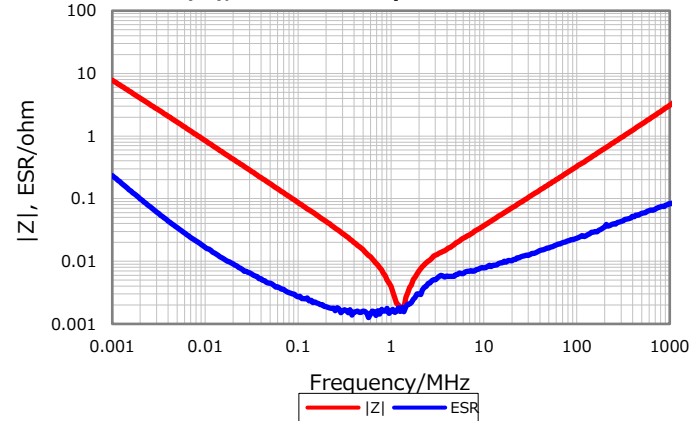

Cap. vs. Freq. Characteristic

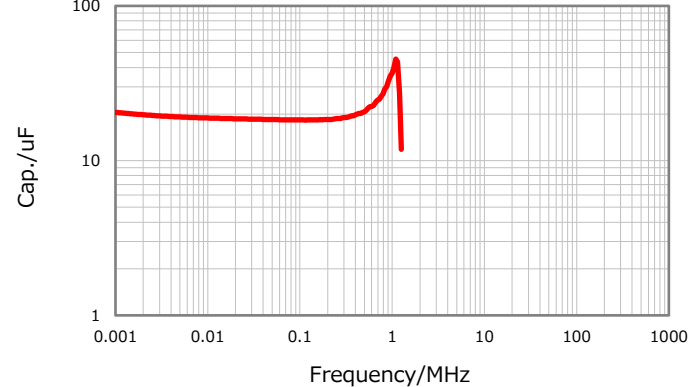

DC Bias Characteristic

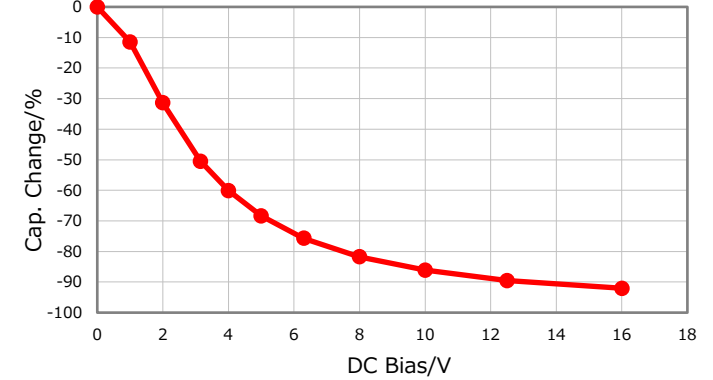

Temperature Characteristics

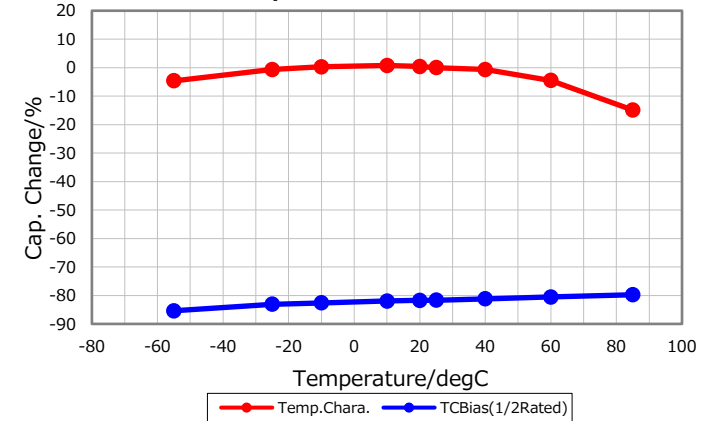

Ripple Temperature Rise Characteristics

