

C3216X7R1H475K160AC

TDK item description : C3216X7R1H475KT****



Application & Main Feature

Commercial grade (General type)

Series

C3216 [EIA 1206]

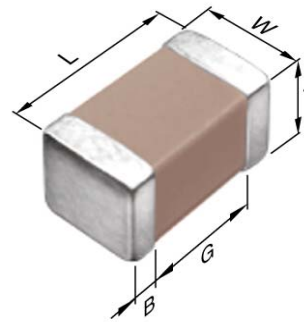

Dimensions

L	3.20±0.20 mm
W	1.60±0.20 mm
T	1.60±0.20 mm
B	0.20 mm min.
G	1.00 mm min.

Temperature Characteristic

X7R (-55 to +125 degC, ±15%)

Rated Voltage

1H (50Vdc)

Capacitance

4.7µF

Capacitance Tolerance

K (±10%)

Dissipation Factor

5 % max.

Insulation Resistance

106 Mohm min.

AEC-Q200

Not Applicable

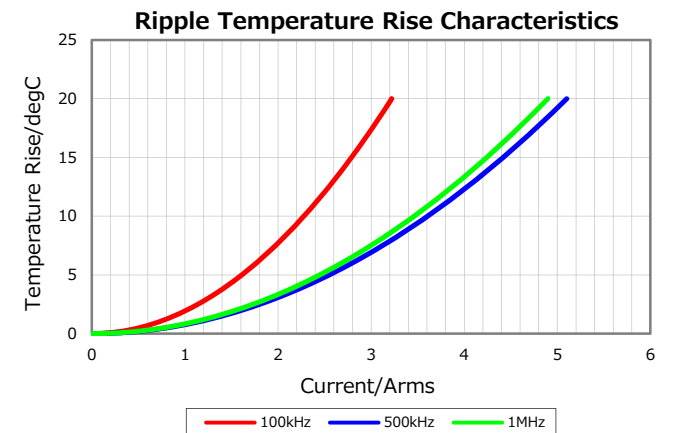
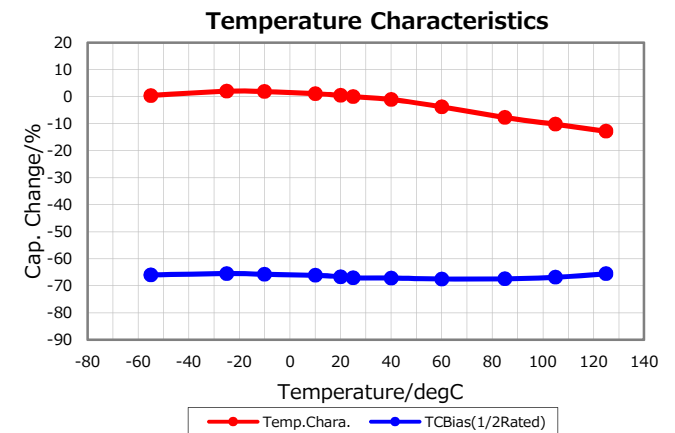
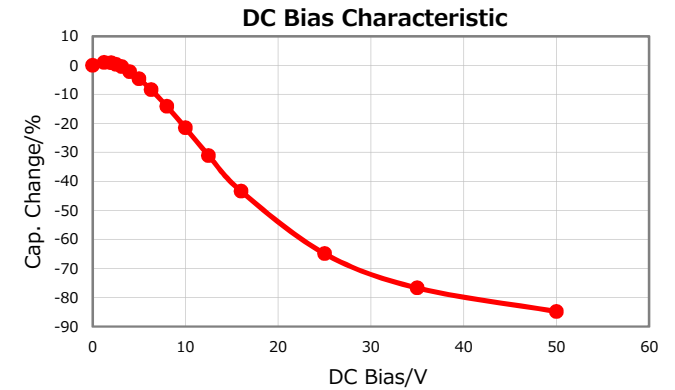
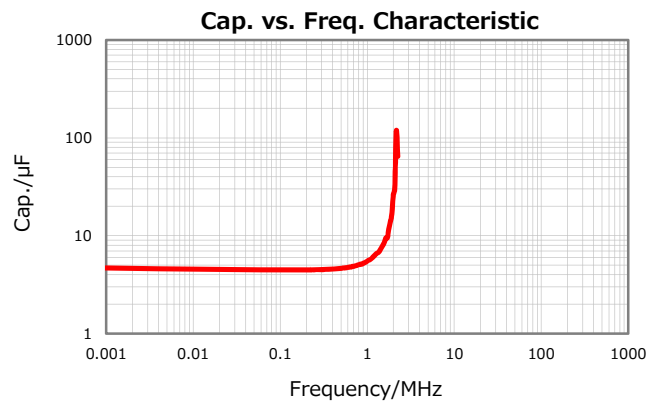
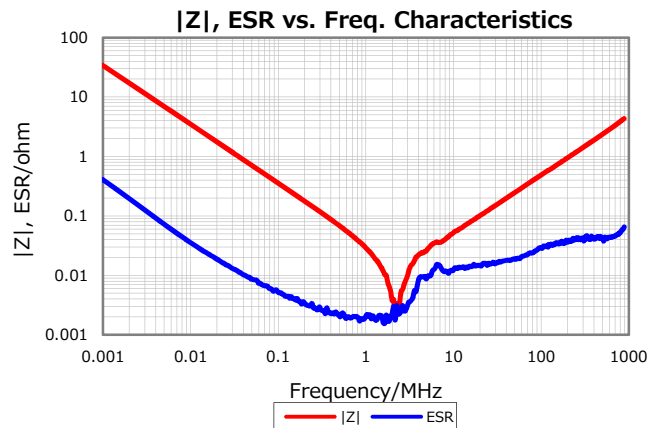

Characterization Sheet (Multilayer Ceramic Chip Capacitors)



All specifications are subject to change without notice.

January 20, 2020