

C3216X7S3D471K130AA

TDK item description : C3216X7S3D471KT****



Application & Main Feature

Commercial grade (General type)

Series

C3216 [EIA 1206]

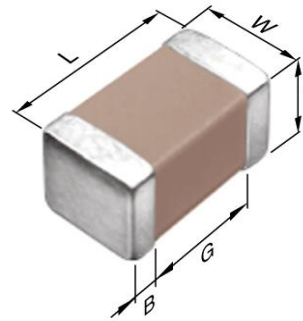

Dimensions

L	3.20±0.20 mm
W	1.60±0.20 mm
T	1.30±0.20 mm
B	0.20 mm min.
G	---

Temperature Characteristic

X7S (-55 to +125 degC, ±22%)

Rated Voltage

3D (2000Vdc)

Capacitance

470pF

Capacitance Tolerance

K (±10%)

DF

3 % max.

Insulation Resistance

10000 Mohm min.

AEC-Q200

Not Applicable

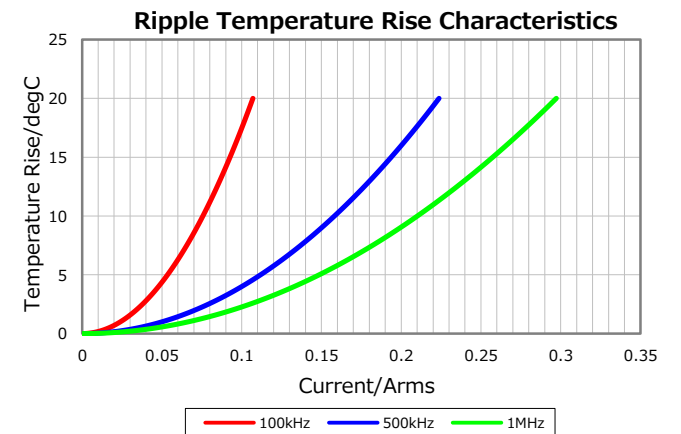
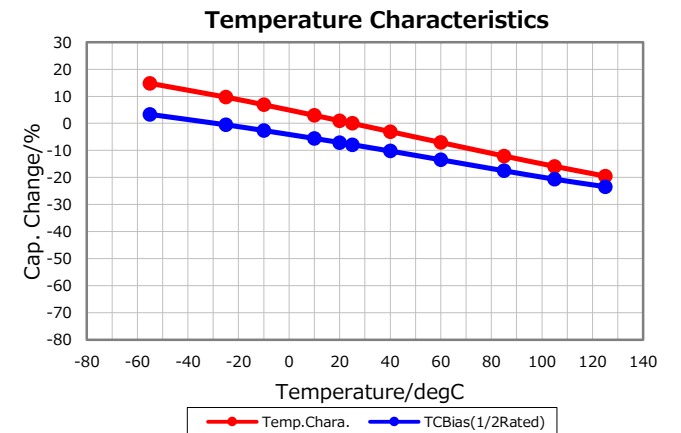
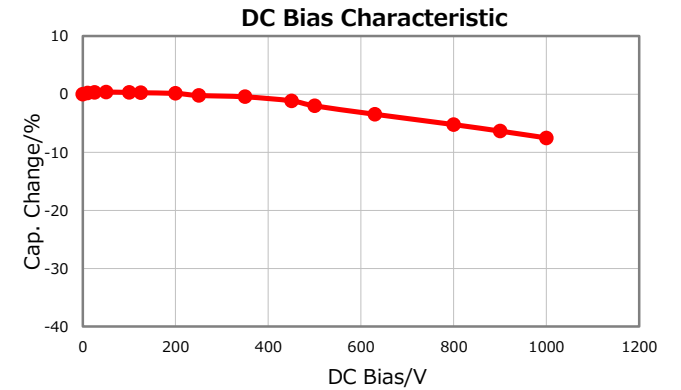
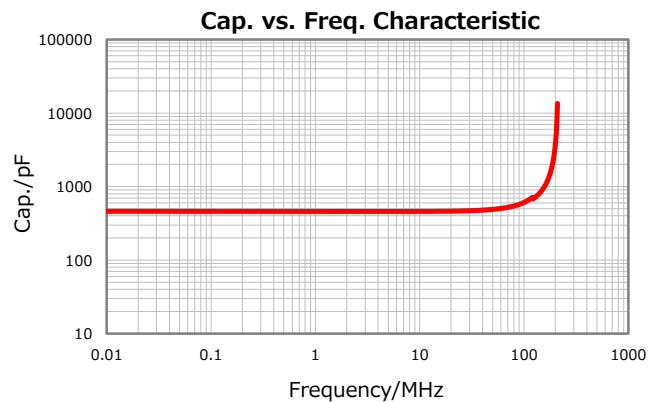
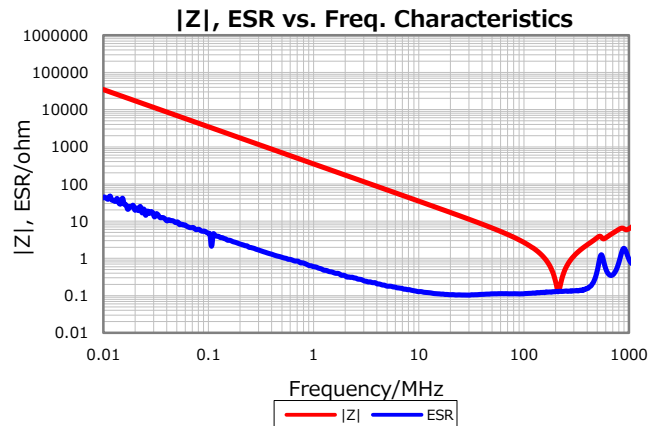

Characterization Sheet (Multilayer Ceramic Chip Capacitors)



All specifications are subject to change without notice.

May 12, 2020