

C3225C0G3A122J200AC

TDK item description : C3225C0G3A122JT****



Application & Main Feature

Commercial grade (General type)

Series

C3225 [EIA 1210]

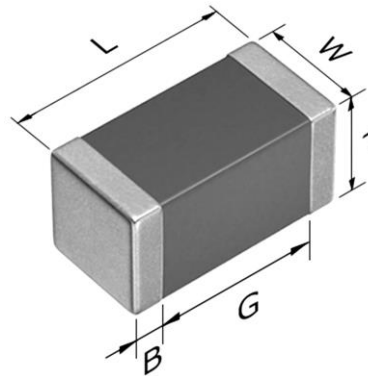

Dimensions

L	3.20±0.40 mm
W	2.50±0.30 mm
T	2.00±0.20 mm
B	0.20 mm min.
G	---

Temperature Characteristic

C0G (-55 to +125 degC, 0±30ppm/°C)

Rated Voltage

3A (1000Vdc)

Capacitance

1.2nF

Capacitance Tolerance

J (±5%)

Q

1,000 min.

Insulation Resistance

10000 Mohm min.

AEC-Q200

Not Applicable

DC Bias Characteristic

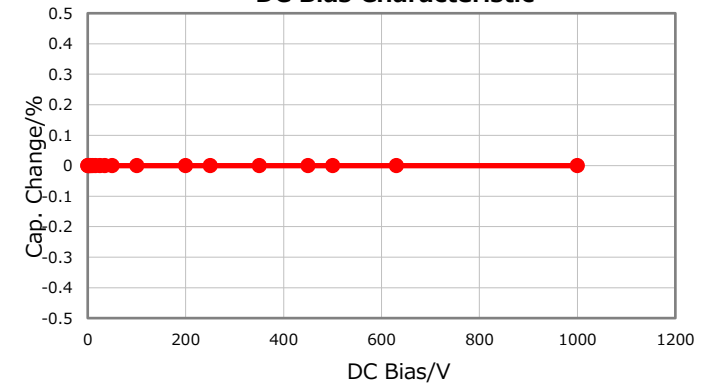

Temperature Characteristics

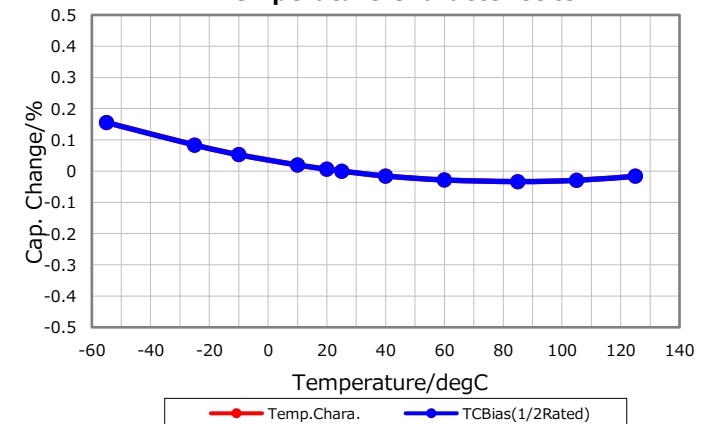

|Z|, ESR vs. Freq. Characteristics

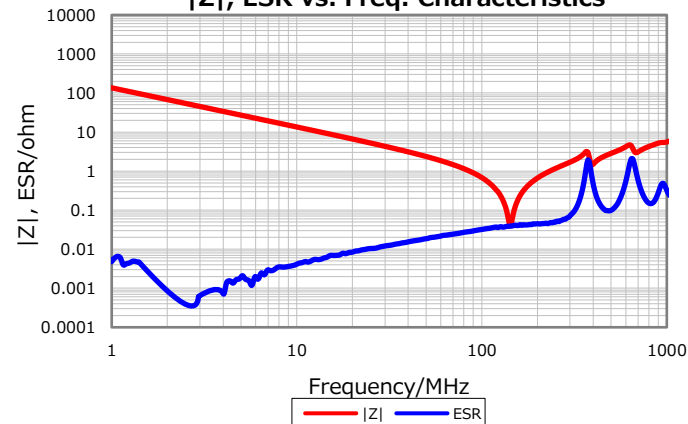

Cap. vs. Freq. Characteristic

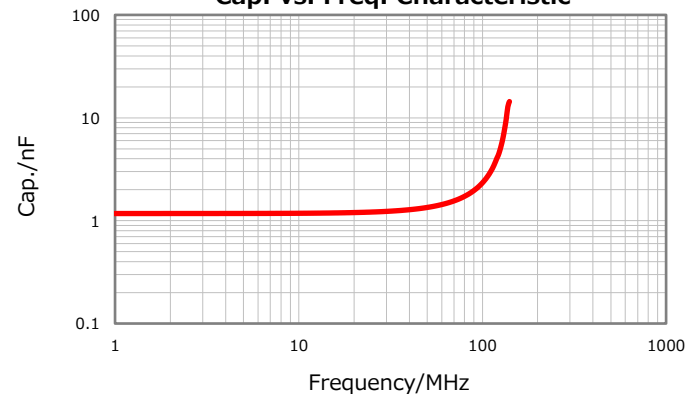

Ripple Temperature Rise Characteristics

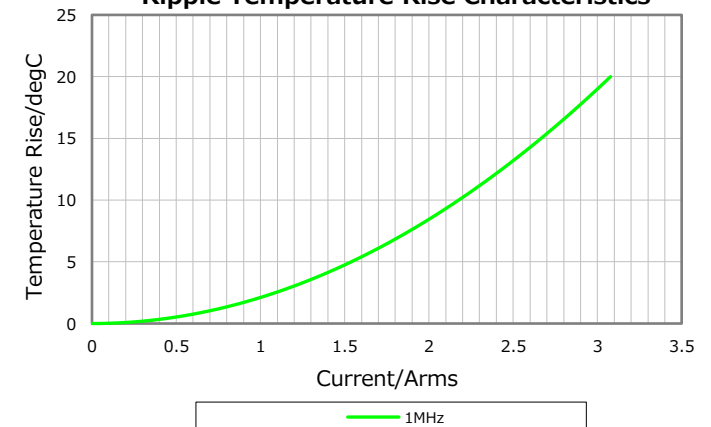

Characterization Sheet (Multilayer Ceramic Chip Capacitors)



All specifications are subject to change without notice.

April 7, 2023