

C3225C0G3A392J200AC

TDK Item Description : C3225C0G3A392JT****



Application & Main Feature

Commercial Grade (High Voltage (1000V and over))

Series

C3225 [EIA 1210]

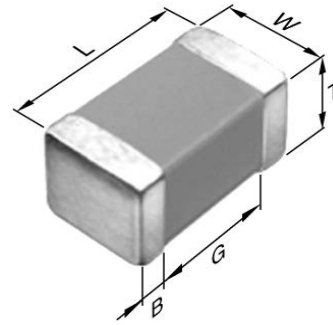

Dimensions

L	3.20mm +/-0.4mm
W	2.50mm +/-0.3mm
T	2.00mm +/-0.2mm
B	0.20mm Min.
G	

Temperature Characteristic

C0G (-55 to 125 degC 0+/-30ppm/degC)

Rated Voltage

3A (1000Vdc)

Capacitance

3.9nF

Capacitance Tolerance

J (+/-5%)

Q Factor

1000 Min.

Insulation Resistance

10Gohm Min

AEC-Q200

Not Applicable

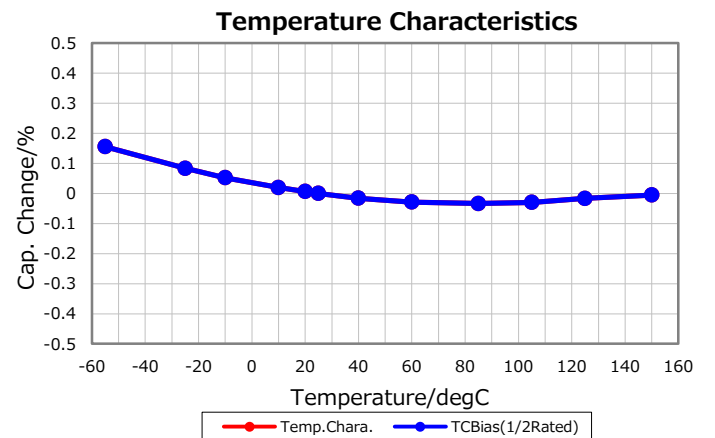
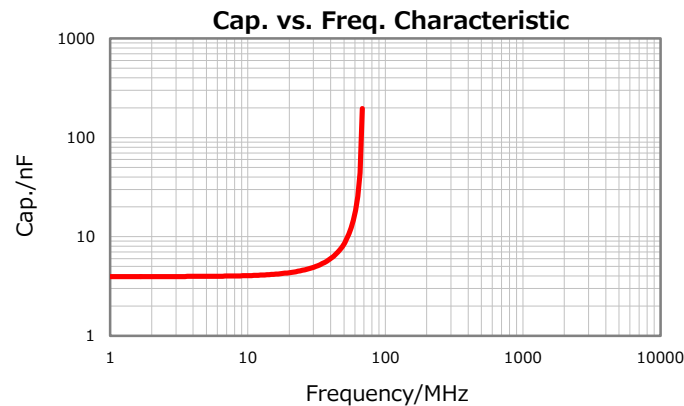
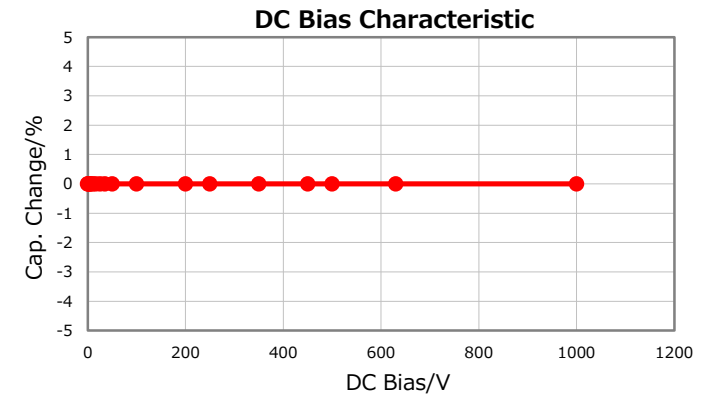
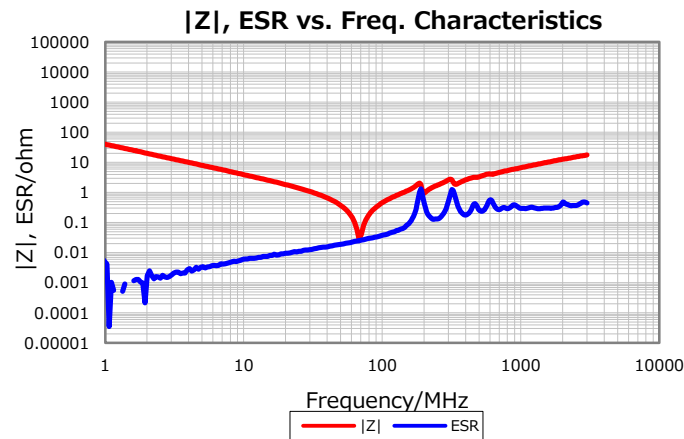

Characterization Sheet (Multilayer Ceramic Chip Capacitors)



All specifications are subject to change without notice.

March 16, 2018