

CAA572C0G3A443J640LH

TDK item description : CAA572C0G3A443JT****



Application & Main Feature

Commercial grade (MEGACAP (Low resistance/Inline))

Series

CAA572(5750) [EIA 2220]

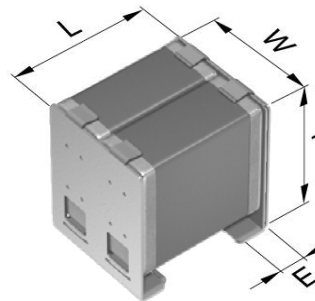

Dimensions

L 6.00±0.50 mm
 W 5.60±0.50 mm
 T 6.40±0.50 mm
 E 1.20±0.20 mm

Temperature Characteristic

COG (-55 to +125 degC, 0±30ppm/°C)

Rated Voltage

3A (1000Vdc)

Capacitance

44nF

Capacitance Tolerance

J (±5%)

Q

1000 min.

Insulation Resistance

10000 Mohm min.

AEC-Q200

Not Applicable

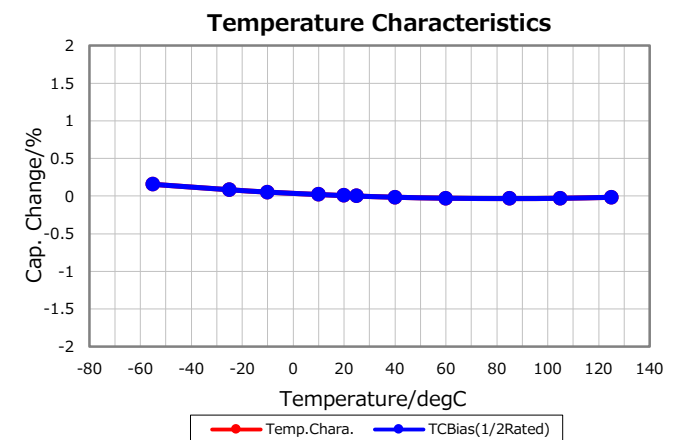
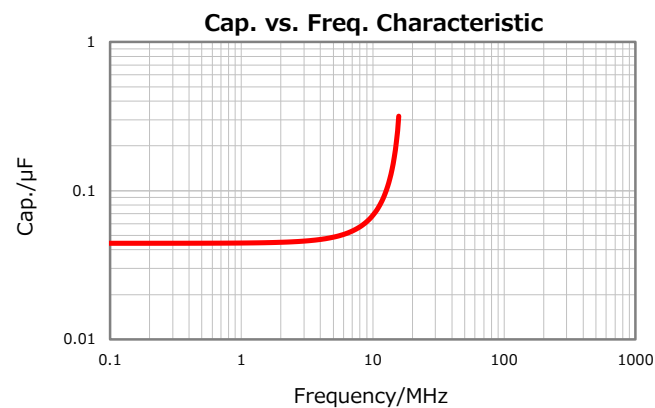
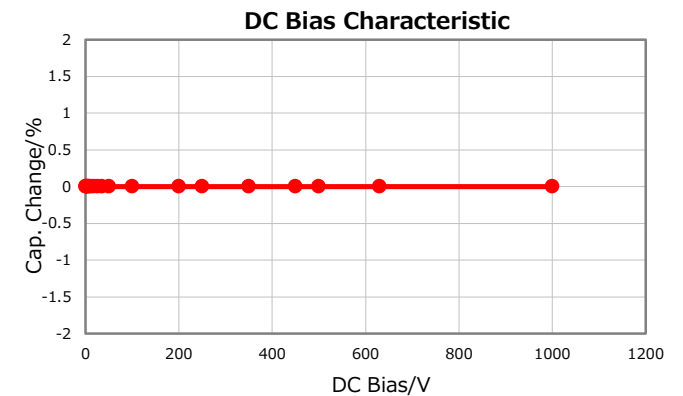
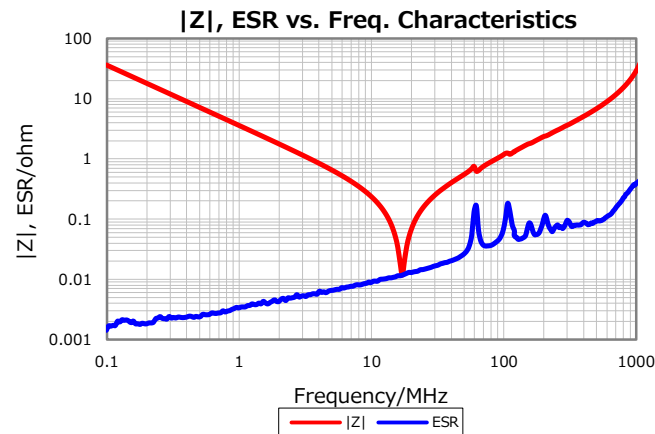

Characterization Sheet (Multilayer Ceramic Chip Capacitors)



All specifications are subject to change without notice.

August 20, 2022