

# CGA3E2X8R1H332K080AE

TDK Item Description : CGA3E2X8R1H332KT\*\*\*S



Equivalent C1608X8R1H332K for Automotive

## Application & Main Feature

Automotive Grade ( Soft Termination )

## Series

CGA3(1608) [EIA CC0603]

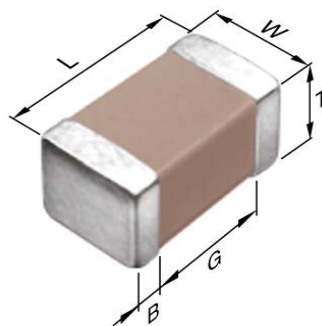

## Dimensions

L	1.60mm +0.2,-0.1mm
W	0.80mm +0.15,-0.1mm
T	0.80mm +0.15,-0.1mm
B	0.20mm Min.
G	0.30mm Min.

## Temperature Characteristic

X8R (-55 to 150 degC +/-15%)

## Rated Voltage

1H (50Vdc)

## Capacitance

3.3nF

## Capacitance Tolerance

K (+/-10%)

## Dissipation Factor

3% Max.

## Insulation Resistance

10Gohm Min

## AEC-Q200

Yes

## |Z|, ESR vs. Freq. Characteristics (Simulation Data)

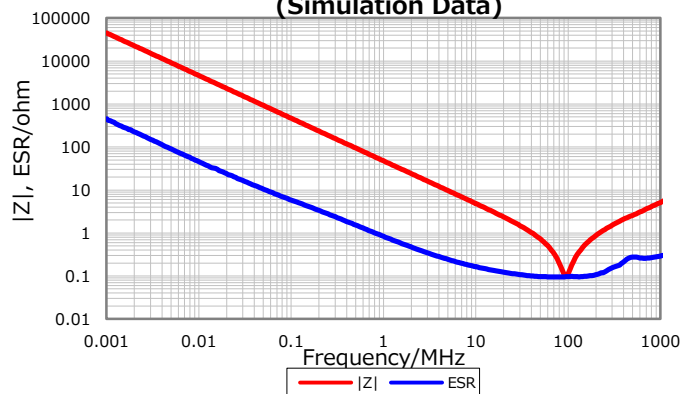

## Cap. vs. Freq. Characteristic

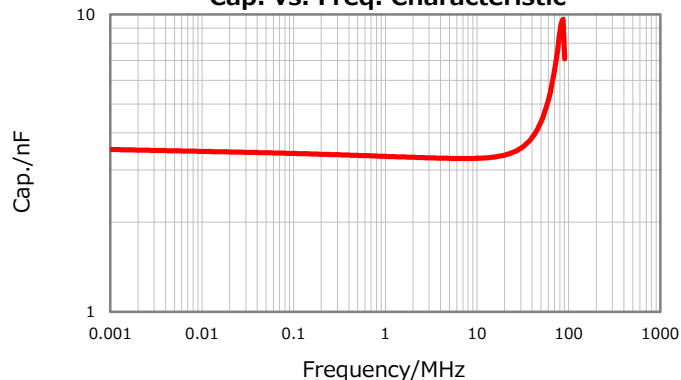

## DC Bias Characteristic

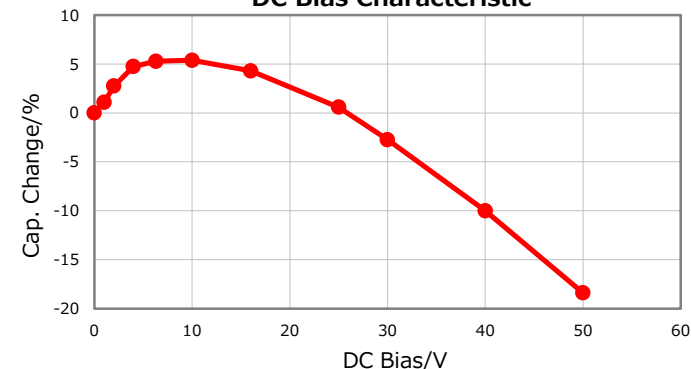

## Temperature Characteristics

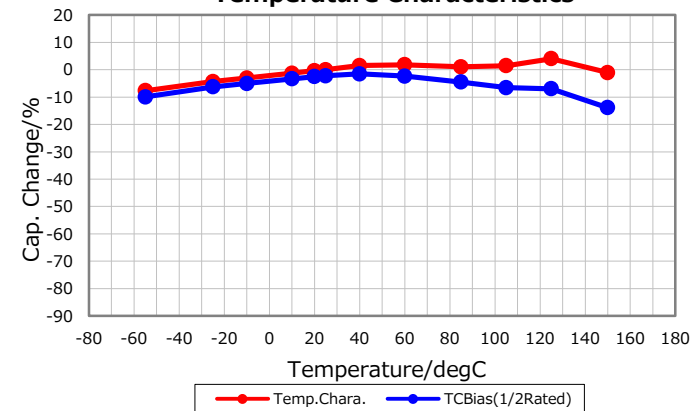

## Ripple Temperature Rise Characteristics

