

CGA3E3X8R1E154M080AD

TDK Item Description : CGA3E3X8R1E154MT***B



Equivalent C1608X8R1E154M for Automotive

Application & Main Feature

Automotive Grade (Conductive Epoxy Application)

Series

CGA3(1608) [EIA 0603]

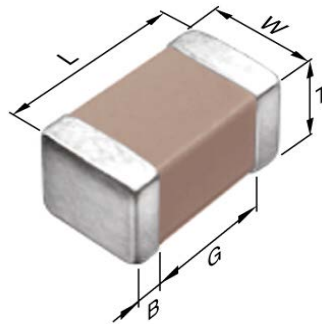

Dimensions

L	1.60mm +/-0.15mm
W	0.80mm +/-0.15mm
T	0.80mm +/-0.15mm
B	0.20mm Min.
G	0.30mm Min.

Temperature Characteristic

X8R (-55 to 150 deg +/-15%)

Rated Voltage

1E (25Vdc)

Capacitance

150nF

Capacitance Tolerance

M (+/-20%)

Dissipation Factor

3% Max.

Insulation Resistance

3.333Gohm Min

AEC-Q200

Yes

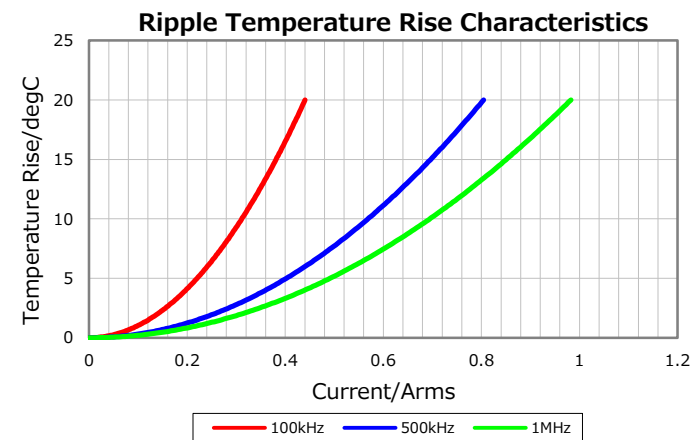
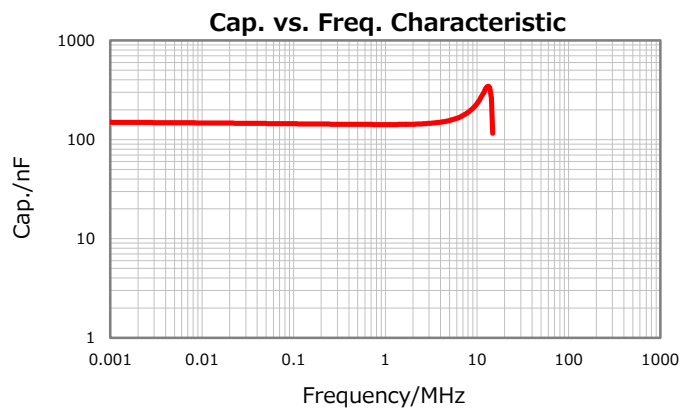
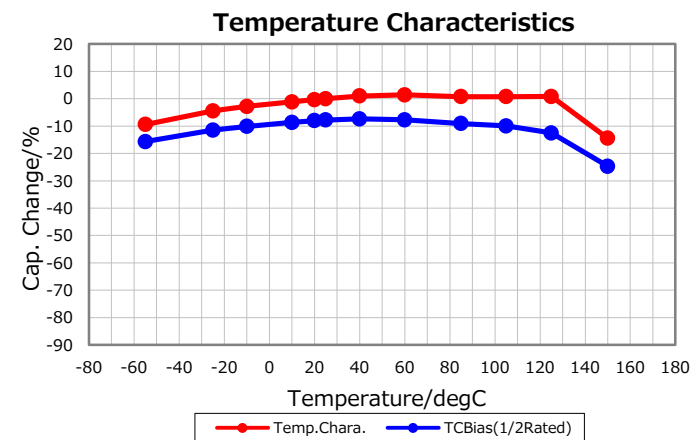
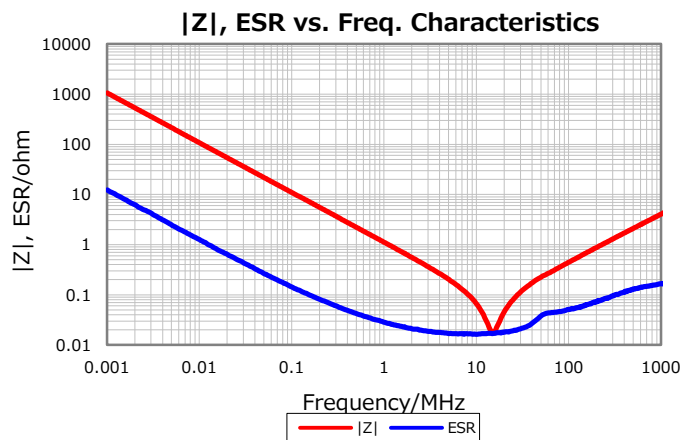
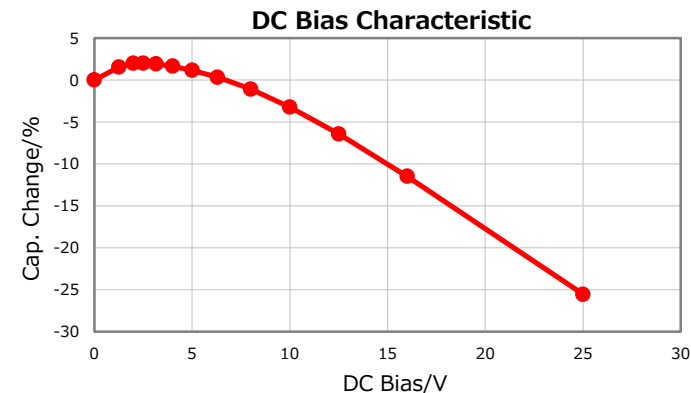

Characterization Sheet (Multilayer Ceramic Chip Capacitors)



All specifications are subject to change without notice.

June 5, 2018