



Mn-Zn

Ferrite Cores for Switching Power Supplies

RM series

REMINDERS FOR USING THESE PRODUCTS

Please be sure to read this manual thoroughly before using the products.

The products listed on this catalog are intended for use in general electronic equipment (AV equipment, telecommunications equipment, home appliances, amusement equipment, computer equipment, personal equipment, office equipment, measurement equipment, industrial robots) under a normal operation and use condition.

The products are not designed or warranted to meet the requirements of the applications listed below, whose performance and/or quality require a more stringent level of safety or reliability, or whose failure, malfunction or trouble could cause serious damage to society, person or property.

When using the products for specific purposes, please first make confirmations in areas such as safety, reliability, and quality.

Please understand that we are not in a position to be held responsible for any damage or the like caused by any use exceeding the range or conditions of this specification sheet or by any use in the specific applications.

- | | |
|---|--|
| (1) Aerospace/Aviation equipment | (8) Public information-processing equipment |
| (2) Transportation equipment (electric trains, ships, etc.) | (9) Military equipment |
| (3) Medical equipment | (10) Electric heating apparatus, burning equipment |
| (4) Power-generation control equipment | (11) Disaster prevention/crime prevention equipment |
| (5) Atomic energy-related equipment | (12) Safety equipment |
| (6) Seabed equipment | (13) Other applications that are not considered general-purpose applications |
| (7) Transportation control equipment | |

When using this product in general-purpose standard applications, you are kindly requested to take into consideration securing protection circuit/equipment or providing backup circuits, etc to ensure higher safety.

Ferrite Cores for Switching Power Supplies

Product compatible with RoHS directive
Halogen-free

Overview of the RM Series

FEATURES

The RM Cores has a shape that is suited to high density mounting, it possesses good shielding qualities, being laid out so that the lead groove does not create an obstruction, and enables the creation of small, high performance transformers and coils.

APPLICATION

Transformers and coils for Switched-mode power supplies (High Mounting Density, Low Profile)

PART NUMBER CONSTRUCTION

| | | | | | |
|-----------------|------------------------|--|---|-------------|----------------------------|
| PC47 | RM4 | Z | - | 1 | 2 |
| Material | Size of RM core | AL-value (Z: without air gap) | | Type | Number of lead slot |
| PC47 | RM4 | | | | |
| | RM5 | | | | |
| | RM6 | | | | |
| | RM8 | | | | |
| | RM10 | | | | |
| | RM12 | | | | |
| | RM14 | | | | |

RANGE OF USE AND STORAGE TEMPERATURE

| Temperature range | |
|-------------------------------|-----------------------------|
| Operating temperature (°C) | Storage temperature (°C) |
| -30 to +105 | -30 to +85 |

○ RoHS Directive Compliant Product: See the following for more details. <https://product.tdk.com/info/en/environment/rohs/index.html>

○ Halogen-free: Indicates that Cl content is less than 900ppm, Br content is less than 900ppm, and that the total Cl and Br content is less than 1500ppm.

 Please be sure to request delivery specifications that provide further details on the features and specifications of the products for proper and safe use.
Please note that the contents may change without any prior notice due to reasons such as upgrading.

Mn-Zn RM Cores

SHAPES AND DIMENSIONS

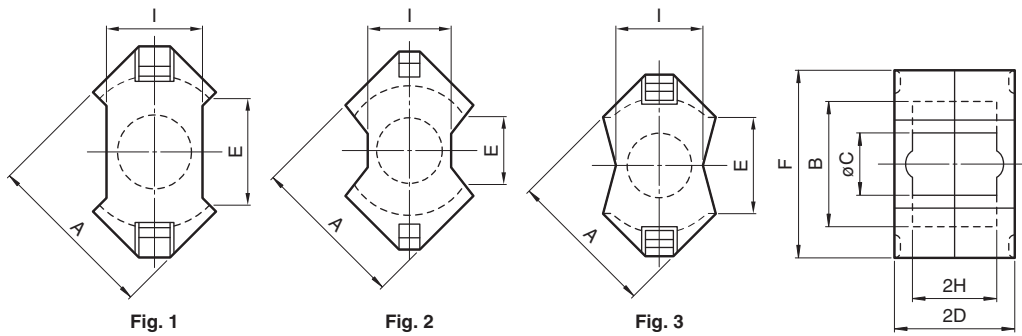

| | | | | | |
|----------|-----------------|----------|------|---------------------|---|
| PC47 | RM6 | Z | - | 1 | 2 |
| Material | Size of RM core | AL-value | Type | Number of lead slot | |

| Part No. | Core | Dimensions (mm) | | | | | | | |
|--------------|-------|-----------------|------------|------------|----------|--------|------------|----------|------------|
| | | A | B | øC | 2D | E min. | F | 2H | I |
| PC47RM4Z-12 | Fig.1 | 9.63±0.18 | 8.15±0.2 | 3.8±0.1 | 10.4±0.1 | 5.8 | 10.8±0.2 | 7.2±0.2 | 4.45±0.15 |
| PC47RM5Z-12 | Fig.1 | 12.05±0.25 | 10.4±0.2 | 4.8±0.1 | 10.4±0.1 | 6.0 | 14.3±0.3 | 6.5±0.2 | 6.6±0.2 |
| PC47RM6Z-12 | Fig.3 | 14.4±0.3 | 12.65±0.25 | 6.3±0.1 | 12.4±0.1 | 8.4 | 17.6±0.3 | 8.2±0.2 | 8.0±0.2 |
| PC47RM8Z-12 | Fig.2 | 19.35±0.35 | 17.3±0.3 | 8.4±0.15 | 16.4±0.1 | 9.8 | 22.75±0.45 | 11.0±0.2 | 10.8±0.2 |
| PC47RM10Z-12 | Fig.2 | 24.15±0.55 | 21.65±0.45 | 10.7±0.2 | 18.6±0.1 | 11.3 | 27.85±0.65 | 12.7±0.3 | 13.25±0.25 |
| PC47RM12Z-12 | Fig.2 | 29.25±0.55 | 25.5±0.5 | 12.6±0.2 | 23.5±0.1 | 12.9 | 36.75±0.65 | 17.1±0.3 | 16.0±0.3 |
| PC47RM14Z-12 | Fig.1 | 34.2±0.5 | 29.5±0.5 | 14.75±0.25 | 28.8±0.2 | 17.0 | 41.6±0.6 | 21.1±0.3 | 18.7±0.3 |

| Part No. | Effective parameter | | | | | Electrical characteristics | | |
|--------------|--------------------------------------|--|---|---|---------------|--|----------------------------|---|
| | Core factor $C_1(\text{mm}^{-1})$ | Effective cross-sectional area $A_e(\text{mm}^2)$ | Effective magnetic path length $\ell_e(\text{mm})$ | Effective core volume $V_e(\text{mm}^3)$ | Weight (g) | AL-value (nH/N ²) 1kHz 0.5mA 100Ts | | Core loss (W) max. 100kHz 200mT 100°C |
| PC47RM4Z-12 | 1.62 | 14.0 | 22.7 | 318 | 1.7 | Without air gap | 63±3% 100±3% 160±3% | 0.11 |
| PC47RM5Z-12 | 0.940 | 23.7 | 22.4 | 530 | 3.0 | 1250 min. | 63±3% 100±3% 160±3% | 0.17 |
| PC47RM6Z-12 | 0.781 | 36.6 | 28.6 | 1050 | 5.5 | 2450±25% | 100±3% 160±3% 250±3% | 0.38 |
| PC47RM8Z-12 | 0.594 | 64.0 | 38.0 | 2430 | 13 | 1950 min. | 100±3% 160±3% 250±3% | 0.91 |
| PC47RM10Z-12 | 0.450 | 98.0 | 44.0 | 4310 | 23 | 4850±25% | 160±3% 250±3% 400±3% | 1.70 |
| PC47RM12Z-12 | 0.406 | 140 | 56.9 | 7970 | 42 | 4150 min. | 160±3% 250±3% 400±3% | 3.00 |
| PC47RM14Z-12 | 0.393 | 178 | 70.0 | 12500 | 70 | 4600 min. | 160±3% 250±3% 400±3% | 4.60 |

⚠ Please be sure to request delivery specifications that provide further details on the features and specifications of the products for proper and safe use.
Please note that the contents may change without any prior notice due to reasons such as upgrading.

Mn-Zn RM series Part No.: PC47RM4Z-12

■ SHAPES AND DIMENSIONS

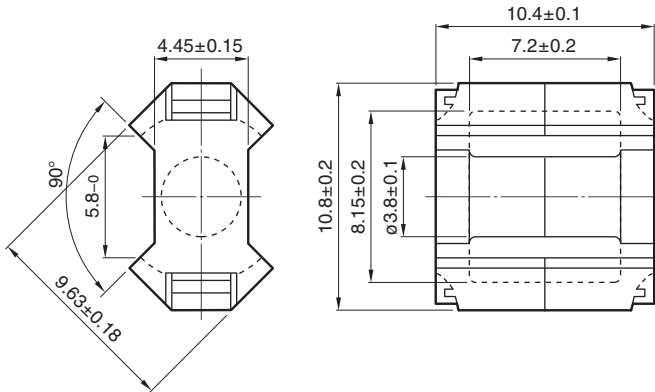

Dimensions in mm

Based on JIS C 2516, IEC Publication 60431 and DIN 41980.

| Effective parameter | | | | | | | | Electrical characteristics | | |
|---------------------|--------------------------------------|--------------------------------------|-----------------------------|---|--|---|---------|----------------------------|-----------------|--------------------------|
| Core factor | Effective magnetic path length l_e | Effective cross-sectional area A_e | Effective core volume V_e | Cross-sectional center pole area A_{cp} | Minimum cross-sectional center pole area $A_{cp \text{ min.}}$ | Cross-sectional winding area of core A_{cw} | Weight | AL-value * | | Core loss |
| C_1 | (mm) | (mm ²) | (mm ³) | (mm ²) | (mm ²) | (mm ²) | (g/set) | (nH/N ²) | | (W)max. |
| 1.62 | 22.7 | 14.0 | 318 | 11.3 | 10.7 | 15.6 | 1.7 | 1kHz 0.5mA | 100kHz 200mT | 100kHz 200mT 100°C |
| | | | | | | | | 680 min. | 1650 min. | 0.11 |

* Coil : ø0.18 2UEW 100Ts

○ Calculated output power (forward converter mode): 8.4W (100kHz)

NI limit vs. AL-value (Typ.)

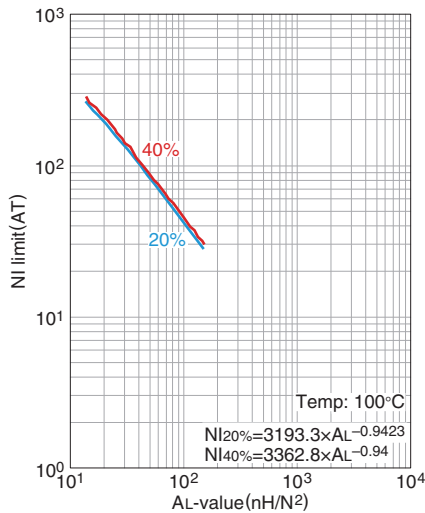

The 20% and 40% graph shows when a 20% and 40% drop from the initial AL-value has been made due to the DC superimposition.

AL-value vs. Air gap length (Typ.)

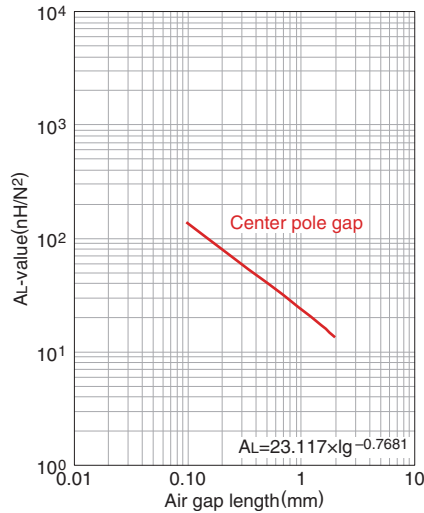

Measuring conditions

- Coil : ø0.18 2UEW 100Ts
- Frequency : 1kHz
- Current level : 0.5mA
- Ambient temperature : 25°C

Temperature rise vs. Total loss (Typ.)

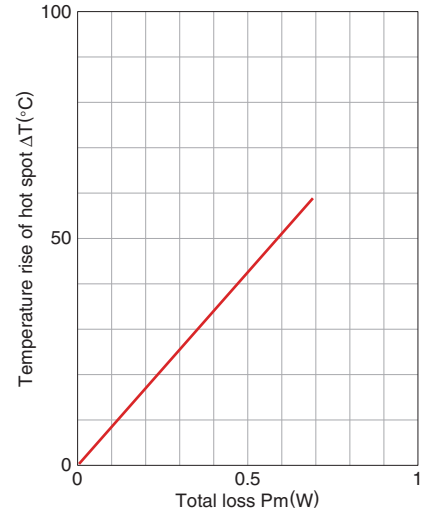

Measuring conditions

- Room space: approx. 400x300x 300cm
- Ambient temperature : 25°C
- Humidity: 45%(%)RH.

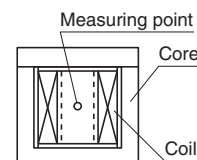

⚠ Please be sure to request delivery specifications that provide further details on the features and specifications of the products for proper and safe use. Please note that the contents may change without any prior notice due to reasons such as upgrading.

Mn-Zn RM series Part No.: PC47RM5Z-12

SHAPES AND DIMENSIONS

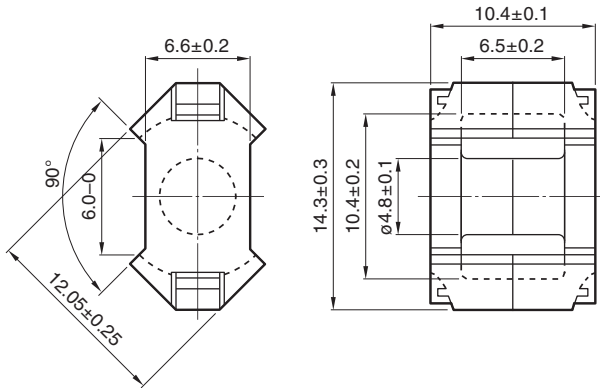

Dimensions in mm

Based on JIS C 2516, IEC Publication 60431 and DIN 41980.

| Effective parameter | | | | | | | | Electrical characteristics | | |
|-------------------------------|--------------------------------------|--------------------------------------|-----------------------------|---|--|---|---------|--------------------------------------|-----------------|-------------------------------------|
| Core factor | Effective magnetic path length l_e | Effective cross-sectional area A_e | Effective core volume V_e | Cross-sectional center pole area A_{cp} | Minimum cross-sectional center pole area $A_{cp \text{ min.}}$ | Cross-sectional winding area of core A_{cw} | Weight | AL-value * | | Core loss |
| C_1 (mm^{-1}) | (mm) | (mm^2) | (mm^3) | (mm^2) | (mm^2) | (mm^2) | (g/set) | (nH/N^2) 1kHz 0.5mA | 100kHz 200mT | (W)max. 100kHz 200mT 100°C |
| 0.940 | 22.4 | 23.7 | 530 | 18.1 | 17.3 | 18.2 | 3.0 | 1250 min. | 3340 min. | 0.17 |

* Coil : $\phi 0.2$ 2UEW 100Ts

○ Calculated output power (forward converter mode): 20.3W (100kHz)

NI limit vs. AL-value (Typ.)

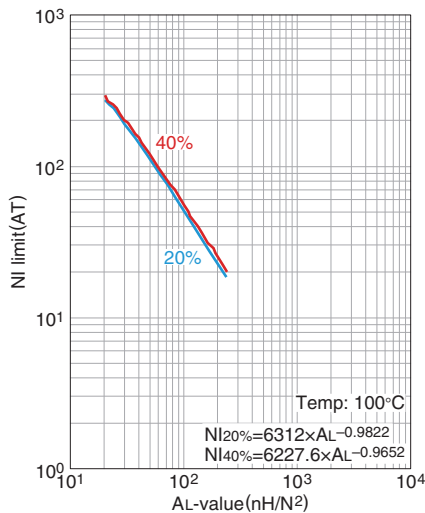

The 20% and 40% graph shows when a 20% and 40% drop from the initial AL-value has been made due to the DC superimposition.

AL-value vs. Air gap length (Typ.)

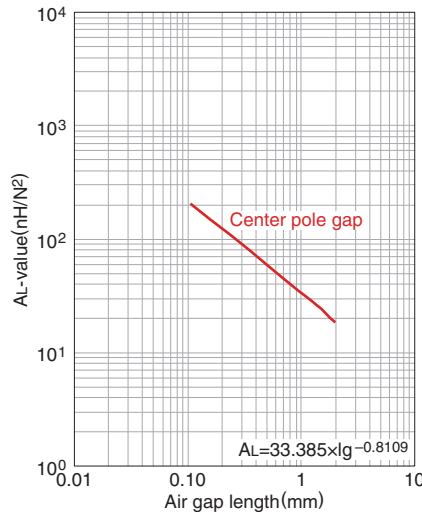

Measuring conditions
 • Coil : $\phi 0.2$ 2UEW 100Ts
 • Frequency : 1kHz
 • Current level : 0.5mA
 • Ambient temperature : 25°C

Temperature rise vs. Total loss (Typ.)

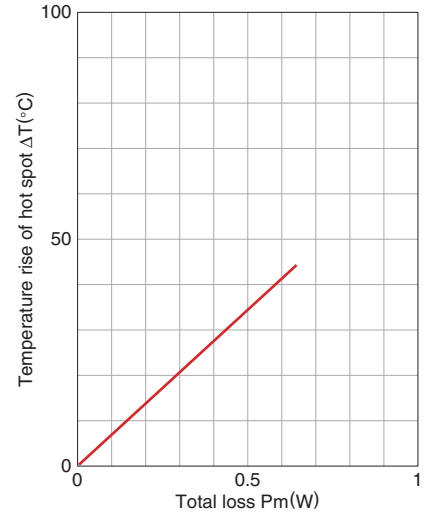

Measuring conditions
 • Room space: approx. 400x300x 300cm
 • Ambient temperature : 25°C
 • Humidity: 45%(%)RH.

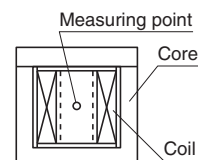

⚠ Please be sure to request delivery specifications that provide further details on the features and specifications of the products for proper and safe use. Please note that the contents may change without any prior notice due to reasons such as upgrading.

Mn-Zn RM series Part No.: PC47RM6Z-12

■ SHAPES AND DIMENSIONS

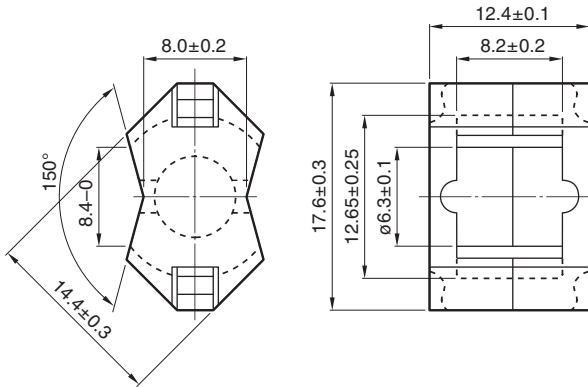

Dimensions in mm

Based on JIS C 2516, IEC Publication 60431 and DIN 41980.

| Effective parameter | | | | | | | | Electrical characteristics | | |
|-------------------------------|--------------------------------------|--------------------------------------|-----------------------------|---|--|---|---------|--------------------------------------|-----------------|-------------------------------------|
| Core factor | Effective magnetic path length l_e | Effective cross-sectional area A_e | Effective core volume V_e | Cross-sectional center pole area A_{cp} | Minimum cross-sectional center pole area $A_{cp \text{ min.}}$ | Cross-sectional winding area of core A_{cw} | Weight | AL-value * | | Core loss |
| C_1 (mm^{-1}) | (mm) | (mm^2) | (mm^3) | (mm^2) | (mm^2) | (mm^2) | (g/set) | (nH/N^2) 1kHz 0.5mA | 100kHz 200mT | (W)max. 100kHz 200mT 100°C |
| 0.781 | 28.6 | 36.6 | 1050 | 31.2 | 30.2 | 26.0 | 5.5 | 2450±25% | 4030 min. | 0.38 |

* Coil : ø0.26 2UEW 100Ts

○ Calculated output power (forward converter mode): 36.2W (100kHz)

NI limit vs. AL-value (Typ.)

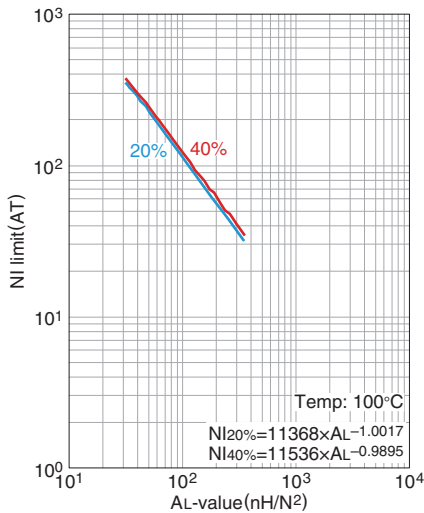

The 20% and 40% graph shows when a 20% and 40% drop from the initial AL-value has been made due to the DC superimposition.

AL-value vs. Air gap length (Typ.)

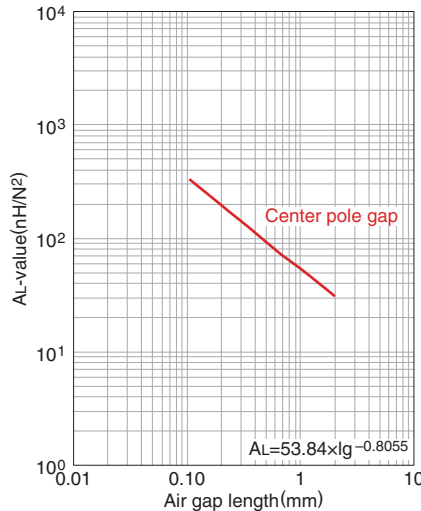

Measuring conditions

- Coil : ø0.26 2UEW 100Ts
- Frequency : 1kHz
- Current level : 0.5mA
- Ambient temperature : 25°C

Temperature rise vs. Total loss (Typ.)

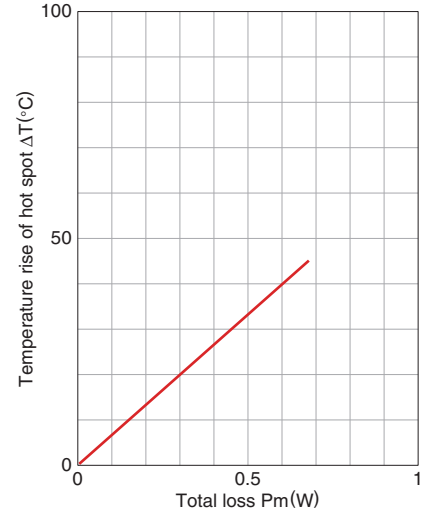

Measuring conditions

- Room space: approx. 400x300x 300cm
- Ambient temperature : 25°C
- Humidity: 45%(%)RH.

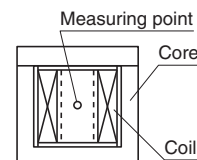

⚠ Please be sure to request delivery specifications that provide further details on the features and specifications of the products for proper and safe use. Please note that the contents may change without any prior notice due to reasons such as upgrading.

Mn-Zn RM series Part No.: PC47RM8Z-12

■ SHAPES AND DIMENSIONS

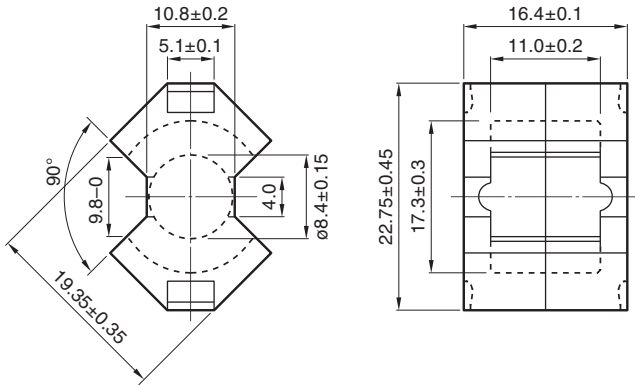

Dimensions in mm

Based on JIS C 2516, IEC Publication 60431 and DIN 41980.

| Effective parameter | | | | | | | | Electrical characteristics | | |
|-------------------------------|--------------------------------------|--------------------------------------|-----------------------------|---|--|---|---------|--------------------------------------|-----------------|-------------------------------------|
| Core factor | Effective magnetic path length l_e | Effective cross-sectional area A_e | Effective core volume V_e | Cross-sectional center pole area A_{cp} | Minimum cross-sectional center pole area $A_{cp \text{ min.}}$ | Cross-sectional winding area of core A_{cw} | Weight | AL-value * | | Core loss |
| C_1 (mm^{-1}) | (mm) | (mm^2) | (mm^3) | (mm^2) | (mm^2) | (mm^2) | (g/set) | (nH/N^2) 1kHz 0.5mA | 100kHz 200mT | (W)max. 100kHz 200mT 100°C |
| 0.594 | 38.0 | 64.0 | 2430 | 55.4 | 53.5 | 48.9 | 13 | 1950 min. | 5290 min. | 0.91 |

* Coil : $\phi 0.4$ 2UEW 100Ts

○ Calculated output power (forward converter mode): 92.4W (100kHz)

NI limit vs. AL-value (Typ.)

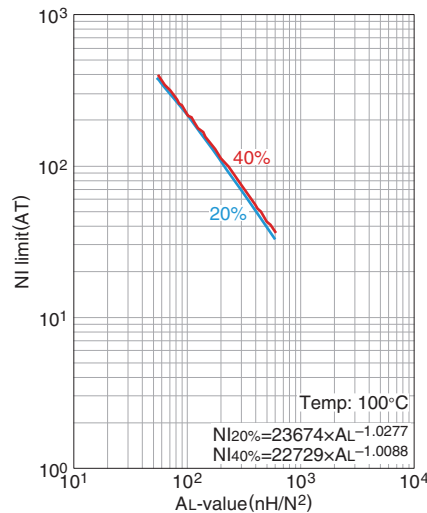

The 20% and 40% graph shows when a 20% and 40% drop from the initial AL-value has been made due to the DC superimposition.

AL-value vs. Air gap length (Typ.)

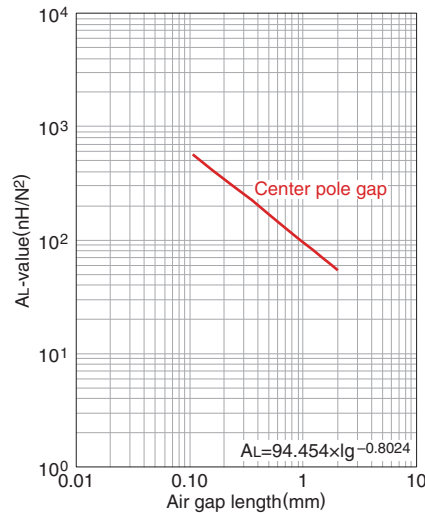

Measuring conditions

- Coil : $\phi 0.4$ 2UEW 100Ts
- Frequency : 1kHz
- Current level : 0.5mA
- Ambient temperature : 25°C

Temperature rise vs. Total loss (Typ.)

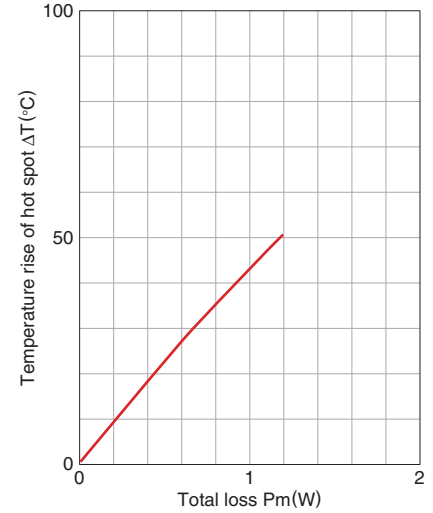

Measuring conditions

- Room space: approx. 400x300x 300cm
- Ambient temperature : 25°C
- Humidity : 45(%)RH.

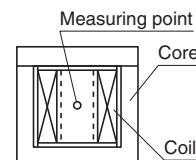

⚠ Please be sure to request delivery specifications that provide further details on the features and specifications of the products for proper and safe use. Please note that the contents may change without any prior notice due to reasons such as upgrading.

Mn-Zn RM series Part No.: PC47RM10Z-12

■ SHAPES AND DIMENSIONS

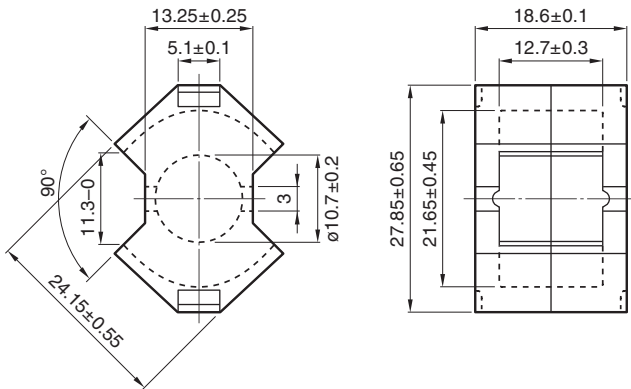

Dimensions in mm

Based on JIS C 2516, IEC Publication 60431 and DIN 41980.

| Effective parameter | | | | | | | | Electrical characteristics | | |
|-------------------------------|--------------------------------------|--------------------------------------|-----------------------------|---|--|---|---------|--------------------------------------|-----------------|-------------------------------------|
| Core factor | Effective magnetic path length l_e | Effective cross-sectional area A_e | Effective core volume V_e | Cross-sectional center pole area A_{cp} | Minimum cross-sectional center pole area $A_{cp \text{ min.}}$ | Cross-sectional winding area of core A_{cw} | Weight | AL-value * | | Core loss |
| C_1 (mm^{-1}) | (mm) | (mm^2) | (mm^3) | (mm^2) | (mm^2) | (mm^2) | (g/set) | (nH/N^2) 1kHz 0.5mA | 100kHz 200mT | (W)max. 100kHz 200mT 100°C |
| 0.450 | 44.0 | 98.0 | 4310 | 89.9 | 86.6 | 69.5 | 23 | 4850±25% | 7000 min. | 1.70 |

* Coil : $\phi 0.4$ 2UEW 100Ts

○ Calculated output power (forward converter mode): 177.8W (100kHz)

NI limit vs. AL-value (Typ.)

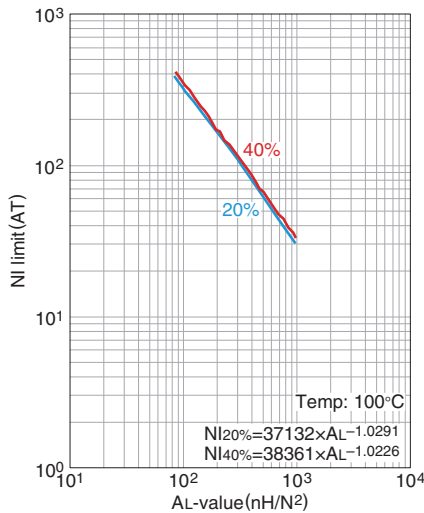

The 20% and 40% graph shows when a 20% and 40% drop from the initial AL-value has been made due to the DC superimposition.

AL-value vs. Air gap length (Typ.)

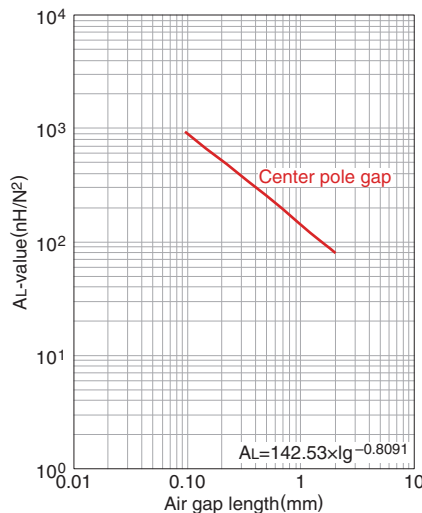

Measuring conditions

- Coil : $\phi 0.4$ 2UEW 100Ts
- Frequency : 1kHz
- Current level : 0.5mA
- Ambient temperature : 25°C

Temperature rise vs. Total loss (Typ.)

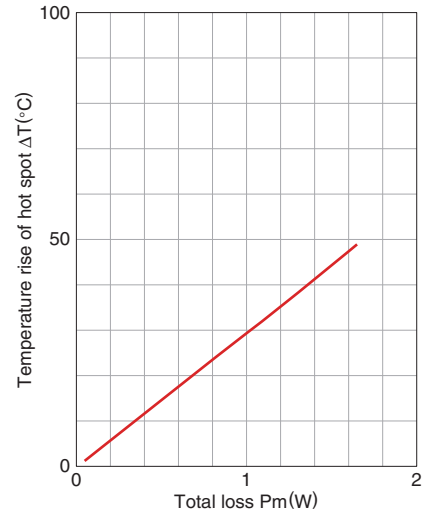

Measuring conditions

- Room space: approx. 400x300x 300cm
- Ambient temperature : 25°C
- Humidity: 45%(%)RH.

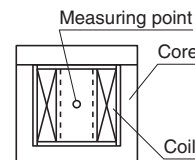

⚠ Please be sure to request delivery specifications that provide further details on the features and specifications of the products for proper and safe use. Please note that the contents may change without any prior notice due to reasons such as upgrading.

Mn-Zn RM series Part No.: PC47RM12Z-12

SHAPES AND DIMENSIONS

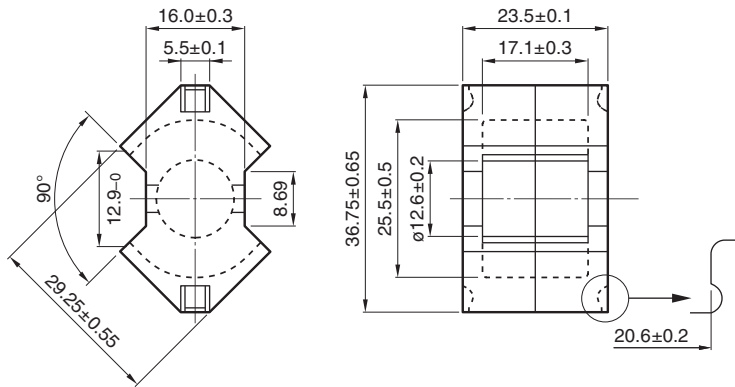

Dimensions in mm

Based on JIS C 2516, IEC Publication 60431.

| Effective parameter | | | | | | | | Electrical characteristics | | |
|-------------------------------|--------------------------------------|--------------------------------------|-----------------------------|---|--|---|---------|--------------------------------------|-----------------|-------------------------------------|
| Core factor | Effective magnetic path length l_e | Effective cross-sectional area A_e | Effective core volume V_e | Cross-sectional center pole area A_{cp} | Minimum cross-sectional center pole area $A_{cp \text{ min.}}$ | Cross-sectional winding area of core A_{cw} | Weight | AL-value * | | Core loss |
| C_1 (mm^{-1}) | (mm) | (mm^2) | (mm^3) | (mm^2) | (mm^2) | (mm^2) | (g/set) | (nH/N^2) 1kHz 0.5mA | 100kHz 200mT | (W)max. 100kHz 200mT 100°C |
| 0.406 | 56.9 | 140 | 7960 | 125 | 121 | 110 | 42 | 4150 min. | 9290 min. | 3.00 |

* Coil : $\phi 0.4$ 2UEW 100Ts

○ Calculated output power (forward converter mode): 466.2W (100kHz)

NI limit vs. AL-value (Typ.)

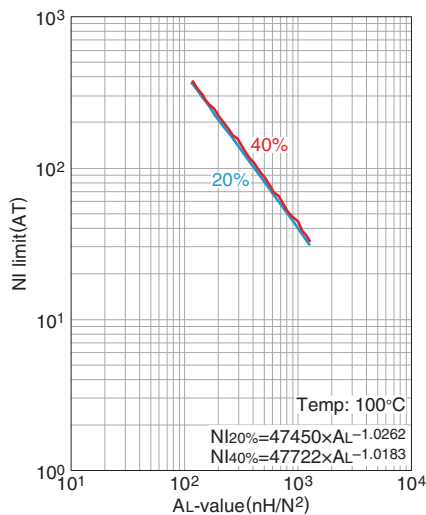

The 20% and 40% graph shows when a 20% and 40% drop from the initial AL-value has been made due to the DC superimposition.

AL-value vs. Air gap length (Typ.)

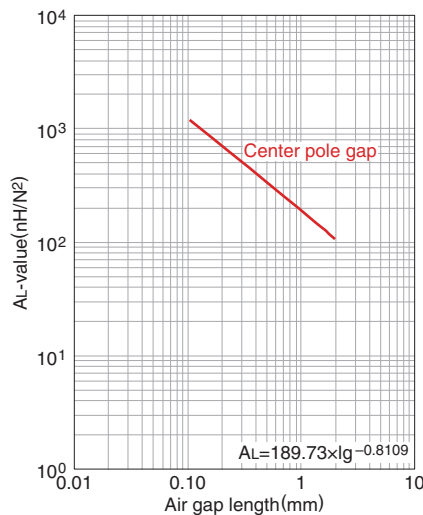

Measuring conditions

- Coil : $\phi 0.4$ 2UEW 100Ts
- Frequency : 1kHz
- Current level : 0.5mA
- Ambient temperature : 25°C

Temperature rise vs. Total loss (Typ.)

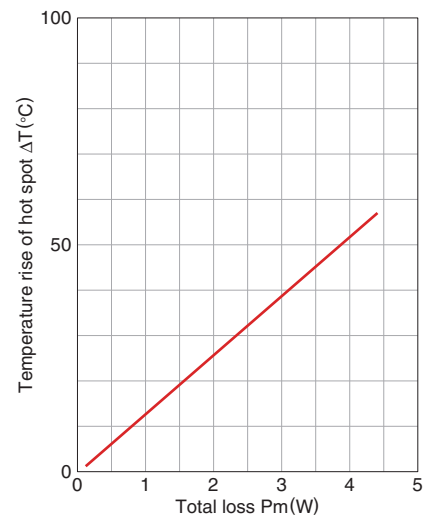

Measuring conditions

- Room space: approx. 400x300x 300cm
- Ambient temperature : 25°C
- Humidity : 45%(%)RH.

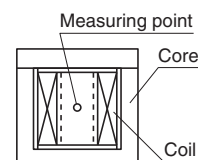

⚠ Please be sure to request delivery specifications that provide further details on the features and specifications of the products for proper and safe use.
Please note that the contents may change without any prior notice due to reasons such as upgrading.

Mn-Zn RM series Part No.: PC47RM14Z-12

■ SHAPES AND DIMENSIONS

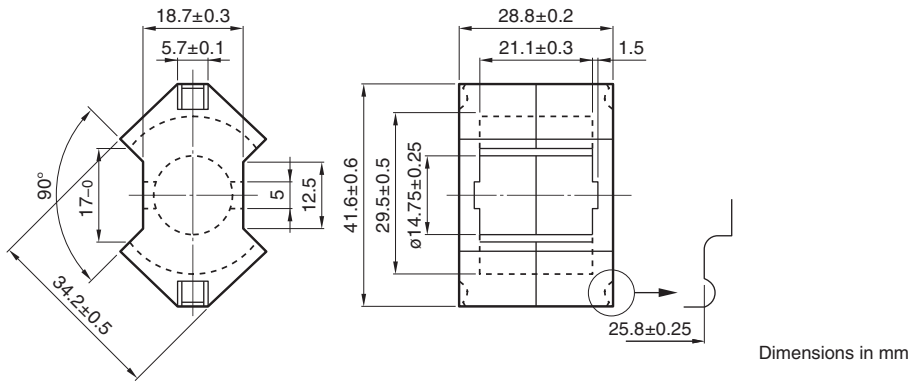

Based on JIS C 2516, IEC Publication 60431 and DIN 41980.

| Effective parameter | | | | | | | | Electrical characteristics | | |
|---------------------------|---|---|--|--|---|--|----------------|----------------------------|-----------------|--------------------------|
| Core factor | Effective magnetic path length l_e (mm) | Effective cross-sectional area A_e (mm ²) | Effective core volume V_e (mm ³) | Cross-sectional center pole area A_{cp} (mm ²) | Minimum cross-sectional center pole area $A_{cp \text{ min.}}$ (mm ²) | Cross-sectional winding area of core A_{cw} (mm ²) | Weight (g/set) | AL-value * | | Core loss |
| C_1 (mm ⁻¹) | | | | | | | | (nH/N ²) | | (W)max. |
| | | | | | | | | 1kHz 0.5mA | 100kHz 200mT | 100kHz 200mT 100°C |
| 0.393 | 70.0 | 178 | 12500 | 171 | 165 | 155 | 70 | 4600 min. | 9590 min. | 4.60 |

* Coil : $\phi 0.4$ 2UEW 100Ts

○ Calculated output power (forward converter mode): 462.6W (100kHz)

NI limit vs. AL-value (Typ.)

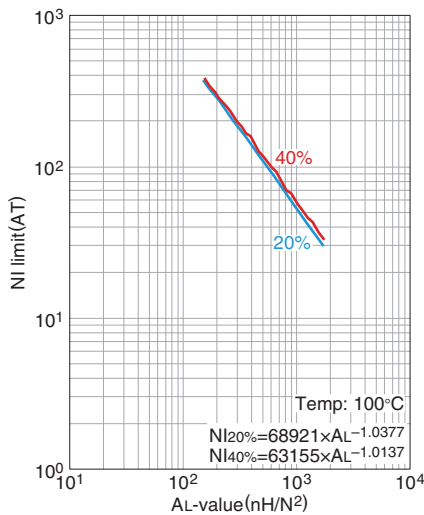

The 20% and 40% graph shows when a 20% and 40% drop from the initial AL-value has been made due to the DC superimposition.

AL-value vs. Air gap length (Typ.)

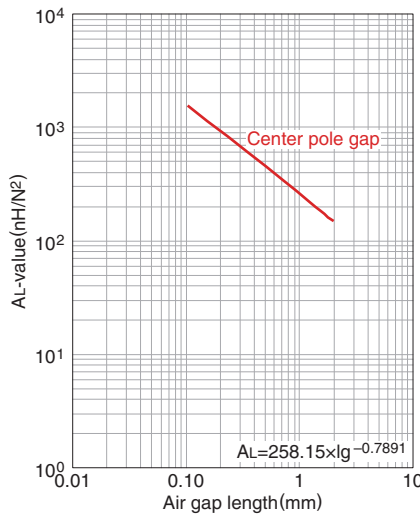

Measuring conditions

- Coil : $\phi 0.4$ 2UEW 100Ts
- Frequency : 1kHz
- Current level : 0.5mA
- Ambient temperature : 25°C

Temperature rise vs. Total loss (Typ.)

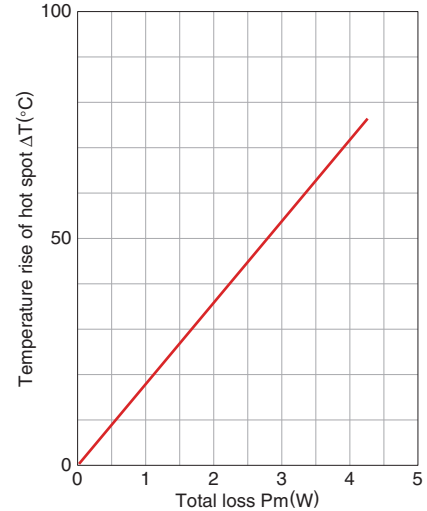

Measuring conditions

- Room space: approx. 400x300x 300cm
- Ambient temperature : 25°C
- Humidity: 45(%)RH.

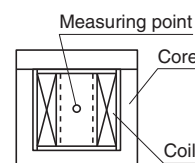

⚠ Please be sure to request delivery specifications that provide further details on the features and specifications of the products for proper and safe use. Please note that the contents may change without any prior notice due to reasons such as upgrading.