

Inductors for decoupling circuits

Soft termination

KLZ series(for automotive A<sup>2</sup>B)

AEC-Q200

## KLZ2012-A type



### FEATURES

- Inductors for automotive A<sup>2</sup>B (Audiobus), compatible with an operating temperature range of -55 to +150°C.
- Due to the narrow tolerance ( $\pm 8\%$ ) of the inductance, the optimal characteristics are realized for automotive A<sup>2</sup>B.
- They are compatible with wide frequency band noise, from low to high frequency.
- It has high DC superimposed properties and is suitable for high current applications.
- Guide electric property resin absorbs external stress, and mechanical stress, resistance force to thermal shock is improved.
- Easing by conductive resin thermal stress, and respond for High-temperature environment of 150°C, too.
- Operating temperature range: -55 to +150°C

### APPLICATION

- Automotive A<sup>2</sup>B (Audiobus)

### PART NUMBER CONSTRUCTION

KLZ	2012	M	HR	3R3	A	T	D69
Series name	L×W×T dimensions 2.0 x 1.25 x 1.25 mm	Product identification code	Specifications (Grade)	Inductance (μH)	Characteristic type	Packaging style	Internal code

### CHARACTERISTICS SPECIFICATION TABLE

L (μH)	Thickness T (mm)	L measuring conditions Frequency (MHz)	DC resistance (Ω)	Rated current (Isat) *1 (mA)max.	Part No.
3.3 ±20%	1.25	2	0.20	350	<a href="#">KLZ2012MHR3R3ATD69</a>

\*1 Current assumed when inductance ratio has decreased by 50% max..

\*2 The inductance tolerance within the same lot is guaranteed to be  $\pm 8\%$  of the center value.

#### Measurement equipment

Measurement item	Product No.	Manufacturer
L	4294A+16034G	Keysight Technologies
DC resistance	Type-755611	Yokogawa

\* Equivalent measurement equipment may be used.



# KLZ2012-A type

## INDUCTANCE FREQUENCY CHARACTERISTICS

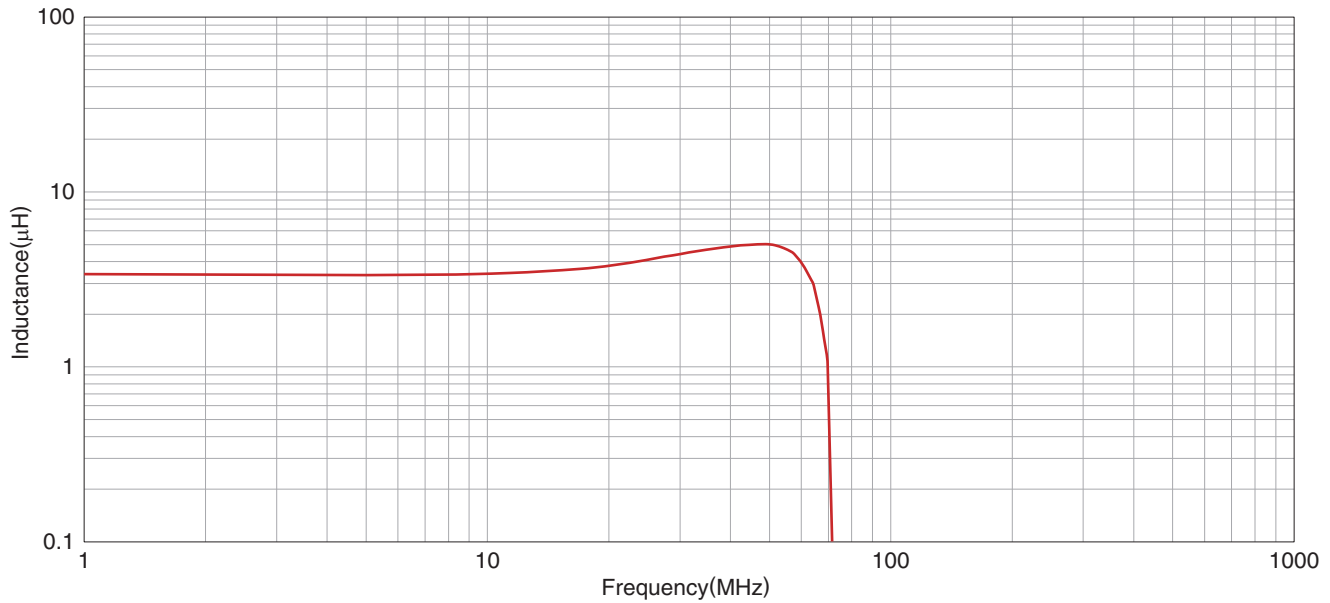

### Measurement equipment

Product No.	Manufacturer
4991A+16192A	Keysight Technologies

\* Equivalent measurement equipment may be used.

## IMPEDANCE VS. FREQUENCY CHARACTERISTICS

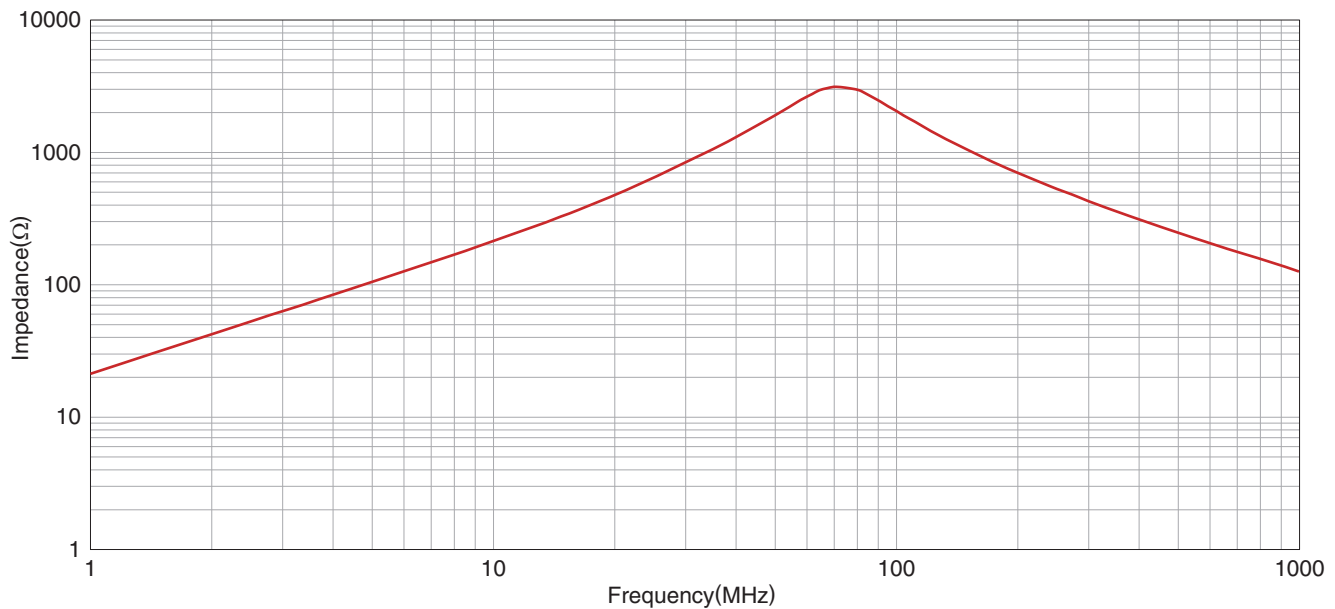

### Measurement equipment

Product No.	Manufacturer
4991A+16192A	Keysight Technologies

\* Equivalent measurement equipment may be used.

# KLZ2012-A type

## INDUCTANCE VS. DC BIAS CHARACTERISTICS

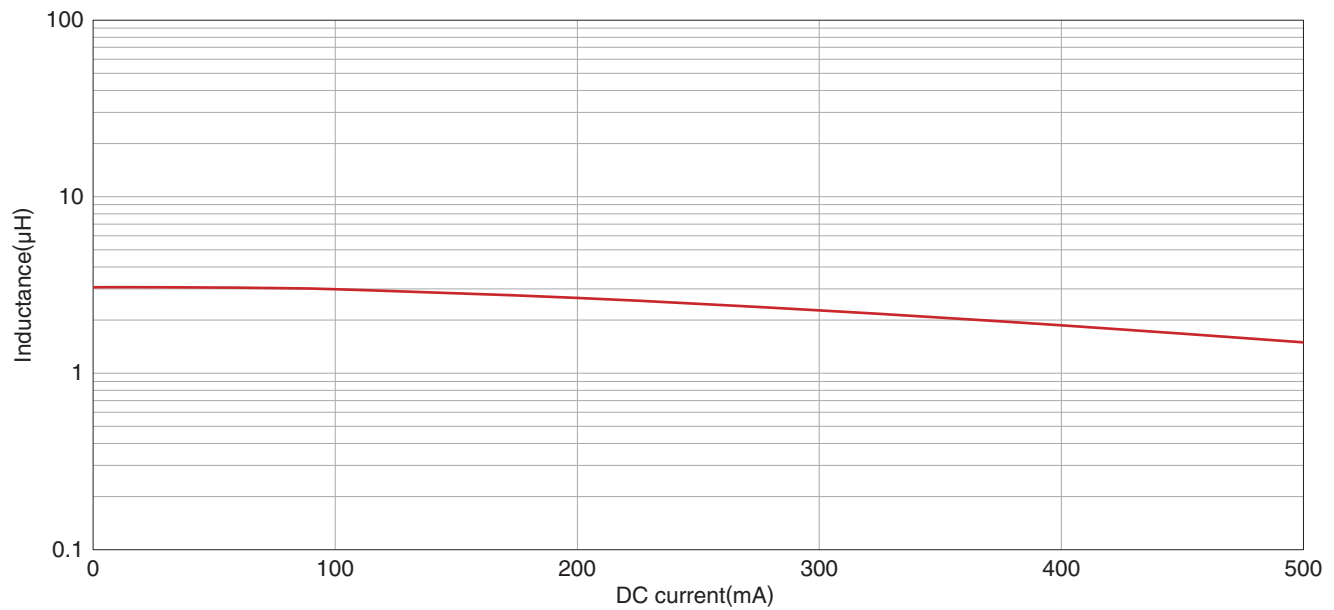

# KLZ2012-A type

## SHAPE & DIMENSIONS

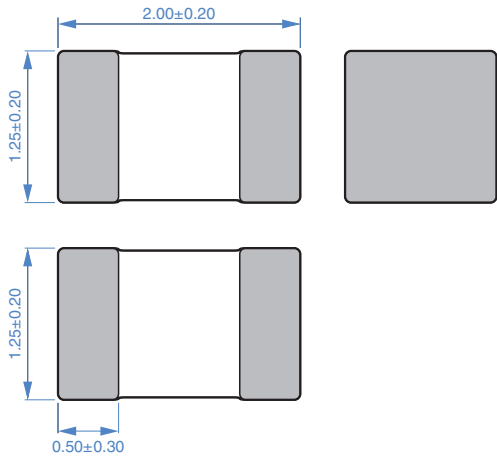

Dimensions in mm

## RECOMMENDED LAND PATTERN

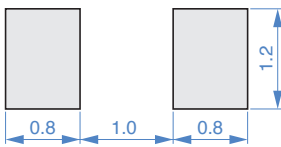

Dimensions in mm

## RECOMMENDED REFLOW PROFILE

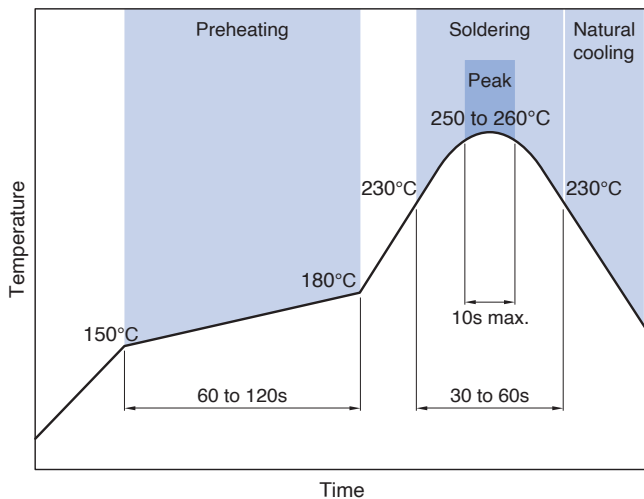

## PACKAGING STYLE

### REEL DIMENSIONS

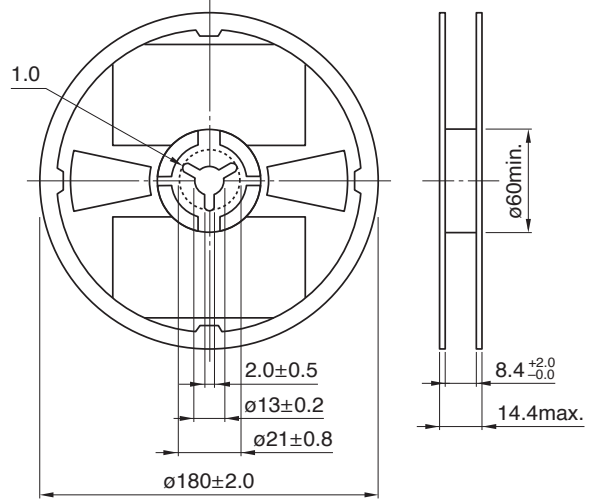

Dimensions in mm

### TAPE DIMENSIONS

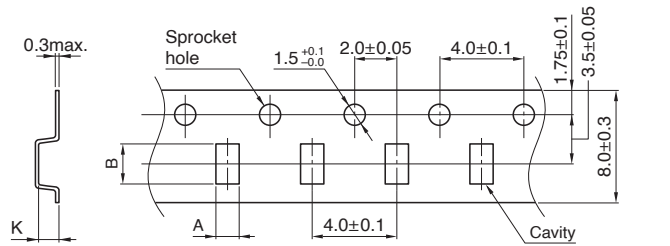

Dimensions in mm

Type	A	B	K
KLZ2012-A	1.5±0.2	2.3±0.2	1.5max.

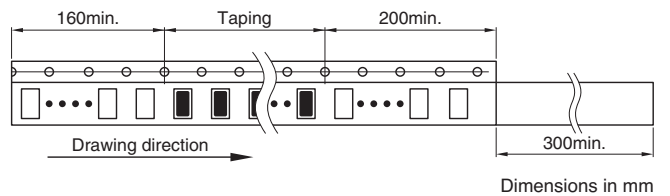

### PACKAGE QUANTITY

Package quantity	2000 pcs/reel
------------------	---------------

## TEMPERATURE RANGE, INDIVIDUAL WEIGHT

Operating temperature range	Storage temperature range *	Individual weight
-55 to +150 °C	-55 to +150 °C	14 mg

\* The storage temperature range is for after the assembly.

## REMINDERS FOR USING THESE PRODUCTS

Before using these products, be sure to request the delivery specifications.

### SAFETY REMINDERS

Please pay sufficient attention to the warnings for safe designing when using this products

### REMINDERS

- The storage period is within 12 months. Be sure to follow the storage conditions (temperature: 5 to 40°C, humidity: 10 to 75% RH or less).  
If the storage period elapses, the soldering of the terminal electrodes may deteriorate.
- Do not use or store in locations where there are conditions such as gas corrosion (salt, acid, alkali, etc.).
- Soldering corrections after mounting should be within the range of the conditions determined in the specifications.  
If overheated, a short circuit, performance deterioration, or lifespan shortening may occur.
- When embedding a printed circuit board where a chip is mounted to a set, be sure that residual stress is not given to the chip due to the overall distortion of the printed circuit board and partial distortion such as at screw tightening portions.
- Self heating (temperature increase) occurs when the power is turned ON, so the tolerance should be sufficient for the set thermal design.
- Carefully lay out the coil for the circuit board design of the non-magnetic shield type.  
A malfunction may occur due to magnetic interference.
- Use a wrist band to discharge static electricity in your body through the grounding wire.
- Do not expose the products to magnets or magnetic fields.
- Do not use for a purpose outside of the contents regulated in the delivery specifications.
- The products described in this catalog are intended to be installed in automobiles or automotive electronic equipment (AV equipment, telecommunications equipment, home appliances, amusement equipment, computer equipment, personal equipment, office equipment, measurement equipment, industrial robots) and to be used in automobiles (including the case where the said automotive product is mounted in a vehicle) or standard applications as general electronic equipment in automotive applications or standard applications as general electronic equipment in automotive applications in accordance with the scope and conditions described in this specification, while the said automotive or general electronic equipment including the said product is intended to be used in the usual operation and usage methods, respectively. Other than automotive or automotive products are not designed or warranted to meet the requirements of the applications listed below, whose performance and/or quality requires a more stringent level of safety or reliability, or whose failure, malfunction or defect could cause serious damage to society, person or property.  
Please understand that we are not responsible for any damage or liability caused by use of the products in any of the applications below or for any other use exceeding the range or conditions set forth in this specification sheet.  
If you intend to use the products in the applications listed below or if you have special requirements exceeding the range or conditions set forth in this specification, please contact us.

- (1) Aerospace/aviation equipment
- (2) Transportation equipment (electric trains, ships, etc.)
- (3) Medical equipment
- (4) Power-generation control equipment
- (5) Atomic energy-related equipment
- (6) Seabed equipment

- (7) Transportation control equipment
- (8) Public information-processing equipment
- (9) Military equipment
- (10) Electric heating apparatus, burning equipment
- (11) Disaster prevention/crime prevention equipment
- (12) Safety equipment
- (13) Other applications that are not considered general-purpose applications

When designing your equipment even for general-purpose applications, you are kindly requested to take into consideration securing protection circuit/device or providing backup circuits in your equipment.