

HWS3000GT-24

EVALUATION DATA

型式データ

INDEX

	PAGE
1. 測定方法 Evaluation Method	
1-1. 測定回路 Circuit used for determination	
測定回路1 Circuit 1 used for determination.....	4
静特性 Steady state data	
通電ドリフト特性 Warm up voltage drift characteristics	
出力保持時間特性 Hold up time characteristics	
出力電圧立ち上がり/立ち下がり特性 Output voltage rise/fall characteristics	
出力電流立ち上がり/立ち下がり特性 Output current rise/fall characteristics	
過電流保護特性 Over current protection (OCP) characteristics	
入力電圧瞬停特性 Response to brown out characteristics	
入力電流波形 Input current waveform	
過渡応答(負荷急変)特性 Dynamic load response characteristics	
出力リップル、ノイズ電流波形 Output ripple and noise current waveform	
測定回路2 Circuit 2 used for determination.....	4
リーク電流特性 Leakage current characteristics	
測定回路3 Circuit 3 used for determination.....	5
過電圧保護特性 Over voltage protection (OVP) characteristics	
測定回路4 Circuit 4 used for determination.....	5
入力サージ電流(突入電流)波形 Inrush current waveform	
測定回路5 Circuit 5 used for determination.....	6
ON/OFFコントロール時出力立ち上がり、立ち下がり特性	
Output rise, fall characteristics with ON/OFF Control	
測定回路6 Circuit 6 used for determination.....	7
出力リップル、ノイズ電圧波形 Output ripple and noise voltage waveform	
測定構成 Configuration used for determination.....	7
EMI特性 Electro-Magnetic Interference characteristics	
(a) 雑音端子電圧(帰還ノイズ) Conducted Emission	
(b) 雑音電界強度(放射ノイズ) Radiated Emission	
1-2. 使用測定機器 List of equipment used.....	8
2. 特性データ Characteristics	
2-1. 定電圧出力モード Constant voltage output mode	
2-1-1. 静特性 Steady state data	
(1) 入力・負荷・温度変動 Regulation - line and load, Temperature drift.....	9
(2) リップルノイズ電圧対出力電流 Ripple noise voltage vs. Output current.....	9
(3) 効率・力率対出力電流 Efficiency and Power factor vs. Output current.....	10
(4) 入力電力対出力電流 Input power vs. Output current.....	10
(5) 入力電流対出力電流 Input current vs. Output current.....	11
2-1-2. 通電ドリフト特性 Warm up voltage drift characteristics.....	12
2-1-3. 出力保持時間特性 Hold up time characteristics.....	12
2-1-4. 出力電圧立ち上がり特性 Output voltage rise characteristics.....	13

2-1-5. 出力電圧立ち下がり特性	Output voltage fall characteristics	13
2-1-6. ON/OFFコントロール時出力立ち上がり、立ち下がり特性	Output rise, fall characteristics with ON/OFF Control	
(a) リモートON/OFFコントロール端子によるON/OFF	ON/OFF control by remote ON/OFF control terminal	14
(b) RS-485通信によるON/OFF	ON/OFF control by RS-485	15
2-1-7. 過渡応答(負荷急変)特性	Dynamic load response characteristics	16
2-1-8. 入力電圧瞬停特性	Response to brown out characteristics	16
2-1-9. 出力リップル、ノイズ波形	Output ripple and noise waveform	17
2-2. 定電流出力モード	Constant current output mode	
2-2-1. 静特性	Steady state data	
(1) 入力・負荷・温度変動	Regulation - line and load, Temperature drift	18
(2) リップルノイズ電流対出力電圧	Ripple noise current vs. Output voltage	18
(3) 効率・力率対出力電圧	Efficiency and Power factor vs. Output voltage	19
(4) 入力電力対出力電圧	Input power vs. Output voltage	19
(5) 入力電流対出力電圧	Input current vs. Output voltage	20
2-2-2. 通電ドリフト特性	Warm up current drift characteristics	21
2-2-3. 出力電流立ち上がり特性	Output current rise characteristics	22
2-2-4. 出力電流立ち下がり特性	Output current fall characteristics	22
2-2-5. ON/OFFコントロール時出力立ち上がり、立ち下がり特性	Output rise, fall characteristics with ON/OFF Control	
(a) リモートON/OFFコントロール端子によるON/OFF	ON/OFF control by remote ON/OFF control terminal	23
(b) RS-485通信によるON/OFF	ON/OFF control by RS-485	24
2-2-6. 入力電圧瞬停特性	Response to brown out characteristics	25
2-2-7. 出力リップル、ノイズ波形	Output ripple and noise waveform	25
2-3. 過電流保護特性	Over current protection (OCP) characteristics	26
2-4. 過電圧保護特性	Over voltage protection (OVP) characteristics	26
2-5. 入力サージ電流(突入電流)波形	Inrush current waveform	27
2-6. 入力電流波形	Input current waveform	27
2-7. リーク電流特性	Leakage current characteristics	28
2-8. EMI特性	Electro Magnetic Interference characteristics	29-30

使用記号Terminology used

Ta	: 周囲温度 Ambient temperature	f	: 周波数 Frequency
Vin	: 入力電圧 Input voltage	Iin	: 入力電流 Input current
Vout	: 出力電圧 Output voltage	Iout	: 出力電流 Output current
Vaux	: AUX電圧 AUX voltage	Iaux	: AUX電流 AUX current

※ 当社測定条件における結果であり、参考値としてお考え願います。
Test results are reference data based on our measurement condition.

1. 測定方法 Evaluation Method

1-1. 測定回路 Circuit used for determination

測定回路1 Circuit 1 used for determination

静特性 Steady state data

通電ドリフト特性 Warm up voltage drift characteristics

出力保持時間特性 Hold up time characteristics

出力電圧立ち上がり/立ち下がり特性 Output voltage rise/fall characteristics

出力電流立ち上がり/立ち下がり特性 Output current rise/fall characteristics

過電流保護特性 Over current protection (OCP) characteristics

入力電圧瞬停特性 Response to brown out characteristics

入力電流波形 Input current waveform

過渡応答（負荷急変）特性 Dynamic load response characteristics

出力リップル、ノイズ電流波形 Output ripple and noise current waveform

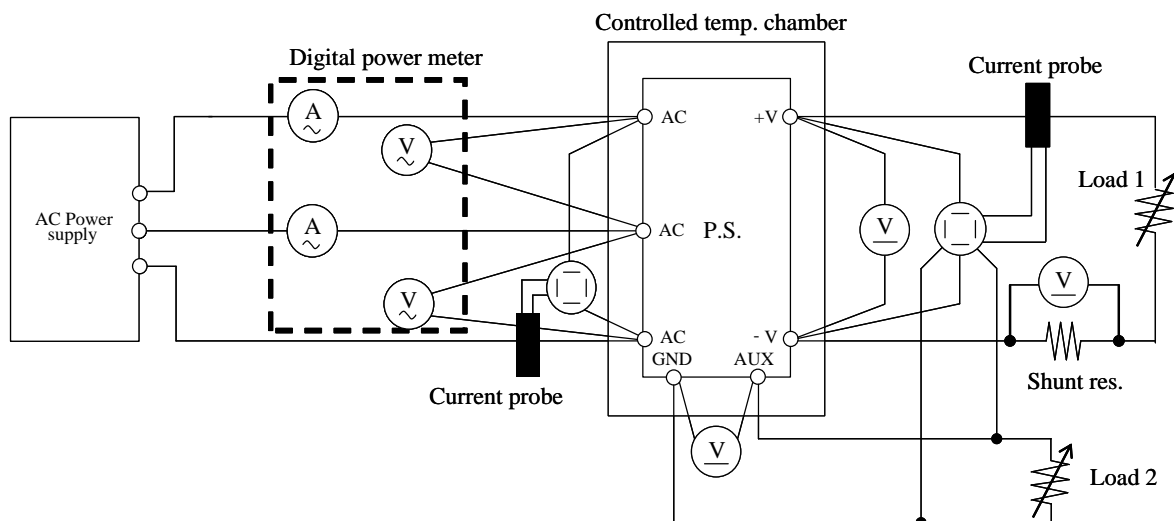

測定回路2 Circuit 2 used for determination

リーク電流特性 Leakage current characteristics

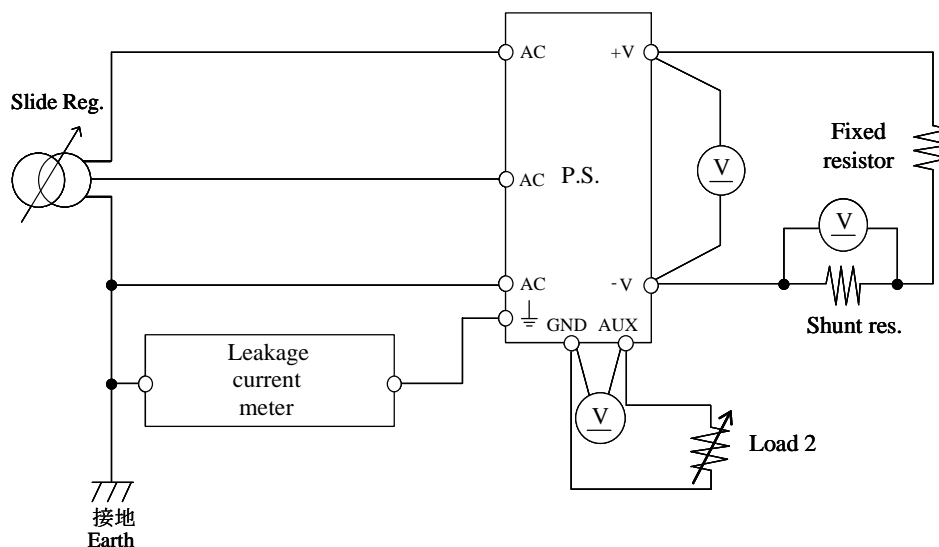

測定回路3 Circuit 3 used for determination

過電圧保護特性 Over voltage protection (OVP) characteristics

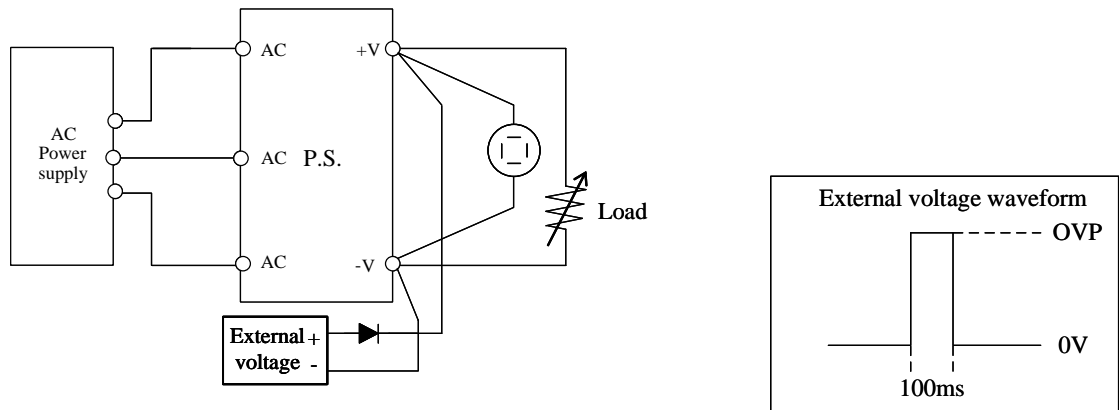

測定回路4 Circuit 4 used for determination

入力サージ電流 (突入電流) 波形 Inrush current waveform

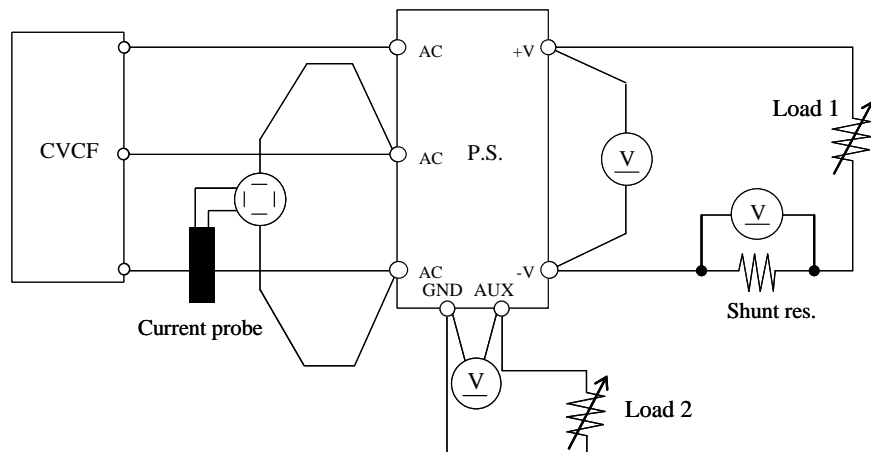

測定回路5 Circuit 5 used for determination

ON/OFFコントロール時出力立ち上がり、立ち下がり特性
Output rise, fall characteristics with ON/OFF Control

(a) リモートON/OFFコントロール端子によるON/OFF
ON/OFF control by remote ON/OFF control terminal

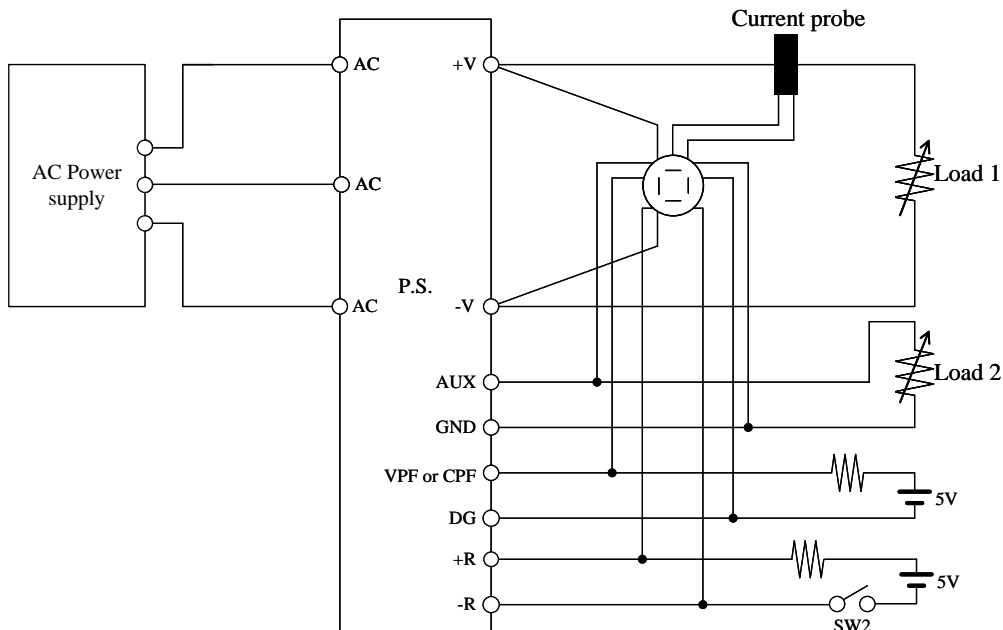

(b) RS-485通信によるON/OFF ON/OFF control by RS-485

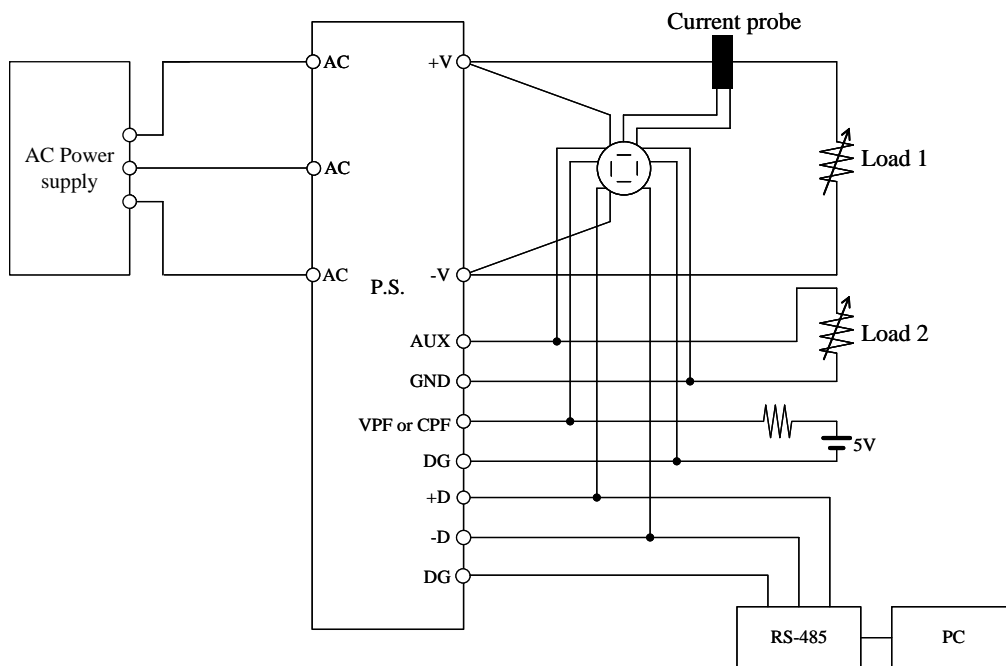

測定回路6 Circuit 6 used for determination

出力リップル、ノイズ電圧波形 Output ripple and noise voltage waveform

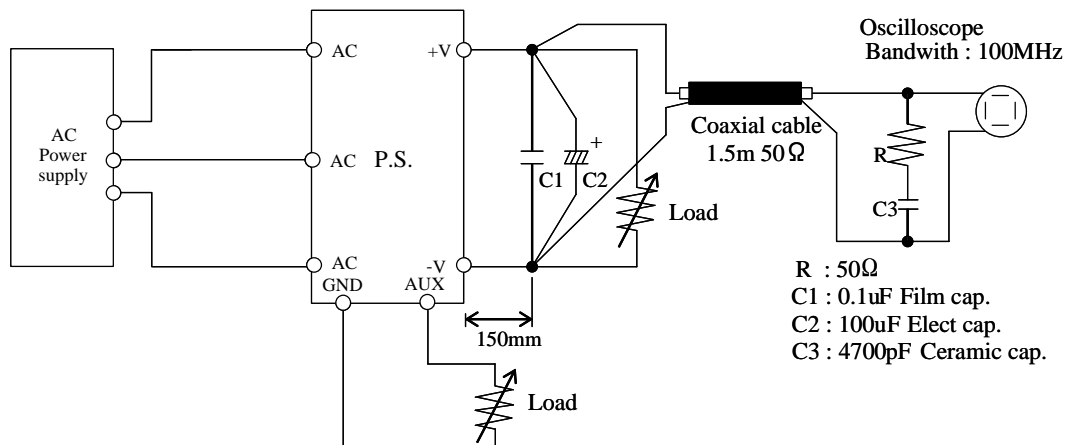

測定構成 Configuration used for determination

EMI特性 Electro-Magnetic Interference characteristics

(a) 雑音端子電圧 (帰還ノイズ) Conducted Emission

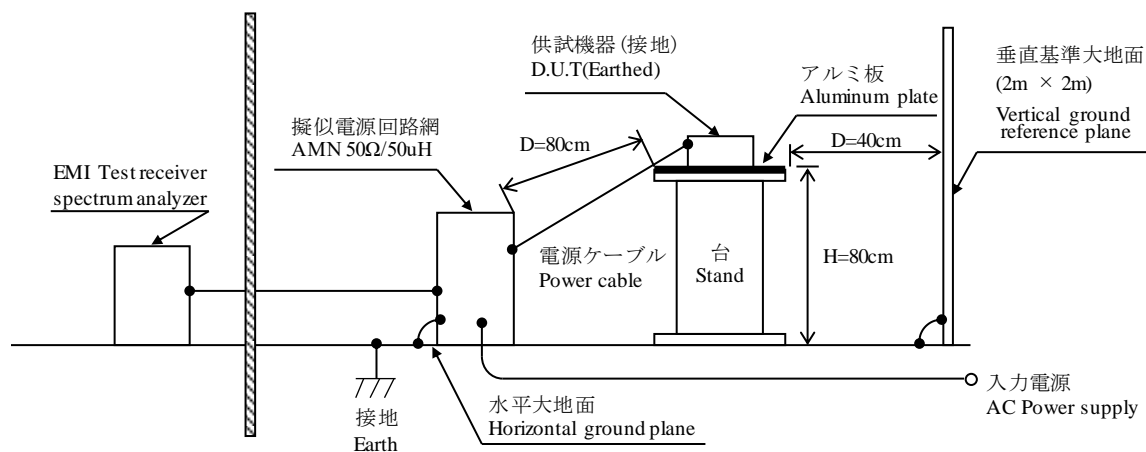

(b) 雑音電界強度 (放射ノイズ) Radiated Emission

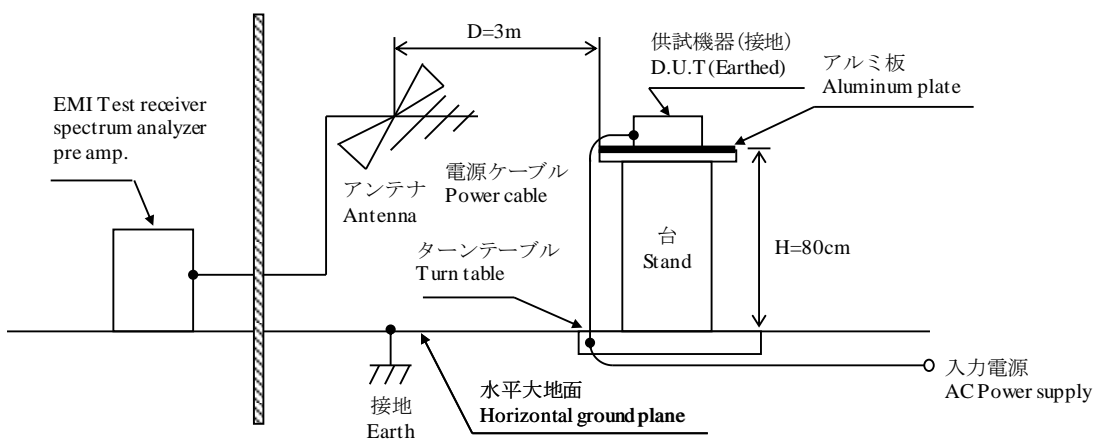

1-2. 使用測定機器 List of equipment used

	EQUIPMENT USED	MANUFACTURER	MODEL NO.
1	DIGITAL STORAGE OSCILLOSCOPE	YOKOGAWA ELECT.	DLM2054
2	DIGITAL MULTIMETER	KEYSIGHT	34970A
3	DIGITAL POWER METER	HIOKI	PW3337
4	CURRENT PROBE	YOKOGAWA ELECT.	701930
5	DYNAMIC DUMMY LOAD	KIKUSI	PLZ10005WSR
6	CVCF	KIKUSUI	PCR18000WEA2R
7	CONTROLLED TEMP. CHAMBER	ESPEC	PSL-4J
8	DYNAMIC DUMMY LOAD	TAKASAGO	FK-200L
9	LEAKAGE CURRENT METER	HIOKI	ST5540
10	EMI TEST RECEIVER / SPECTRUM ANALYZER	ROHDE & SCHWARZ	ESR3
11	PRE AMP.	SONOMA	310N
12	AMN	SCHWARZBECK	NNLK8121
13	ANTENNA	TESEQ	CBL6111D

2. 特性データ Characteristics

2-1. 定電圧出力モード Constant voltage output mode

2-1-1. 静特性 Steady state data

(1) 入力・負荷・温度変動 Regulation - line and load, Temperature drift

1. Regulation - line and load

Condition Ta : 25 °C

Iout \ Vin	170VAC	200VAC	230VAC	265VAC	Line regulation	
0A	24.115V	24.118V	24.115V	24.118V	3mV	0.013%
62.5A	23.988V	23.987V	23.987V	23.991V	4mV	0.017%
125.0A	23.996V	23.994V	23.993V	23.993V	3mV	0.013%
Load regulation	127mV	131mV	128mV	127mV		
	0.529%	0.546%	0.533%	0.529%		

2. Temperature drift

Conditions Vin : 200 VAC

Iout : 125.0 A

Ta	-20°C	+25°C	+50°C	Temperature stability	
Vout	23.917V	23.994V	23.980V	77mV	0.321%

(2) リップルノイズ電圧対出力電流 Ripple noise voltage vs. Output current

Conditions

Vin : 200 VAC

Vout : 24 V

Ta : -20 °C ---

25 °C - - -

50 °C —

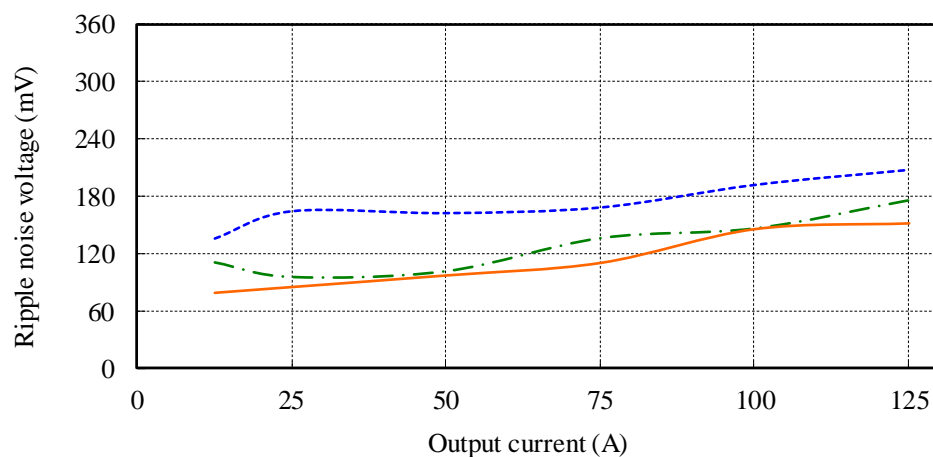

(3) 効率・力率対出力電流 Efficiency and Power factor vs. Output current

Conditions Vin : 200 VAC ———
 230 VAC - - - -
 Vout : 24 V
 Iaux : 0 %
 Ta : 25 °C

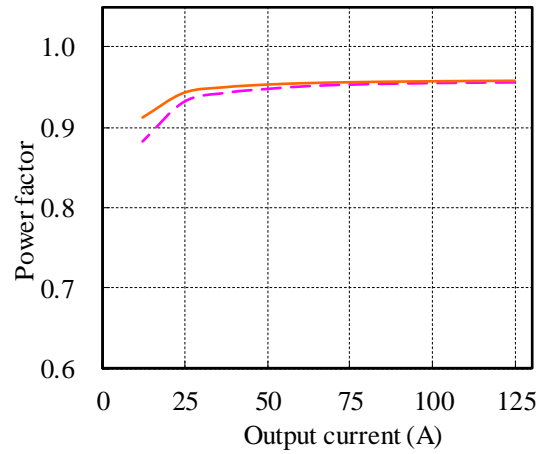
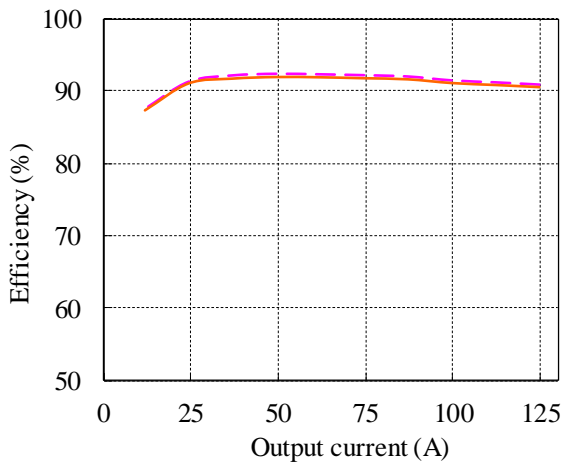

(4) 入力電力対出力電流 Input power vs. Output current

Conditions Vin : 200 VAC ———
 230 VAC - - - -
 Vout : 24 V
 Iaux : 0 %
 Ta : 25 °C

Vin	Input power	
	Iout : 0%	Control OFF
200VAC	10.2W	7.0W
230VAC	10.0W	7.0W

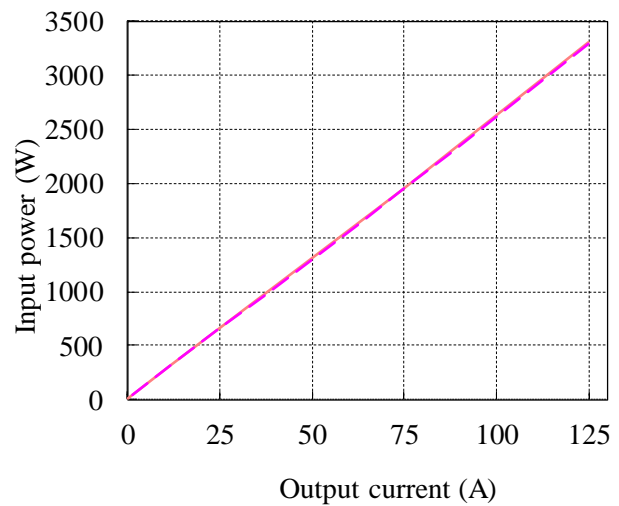

2-1-2. 通電ドリフト特性 Warm up voltage drift characteristics

Conditions V_{in} : 200 VAC
 V_{out} : 24 V
 I_{out} : 125 A
 T_a : 25 °C

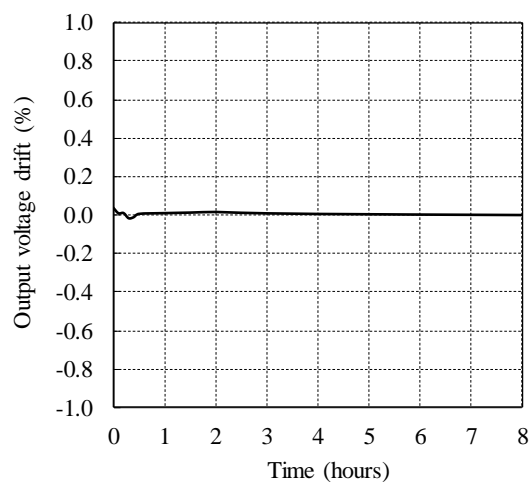

2-1-3. 出力保持時間特性 Hold up time characteristics

Conditions V_{in} : 200 VAC
 V_{out} : 24 V
 T_a : 25 °C

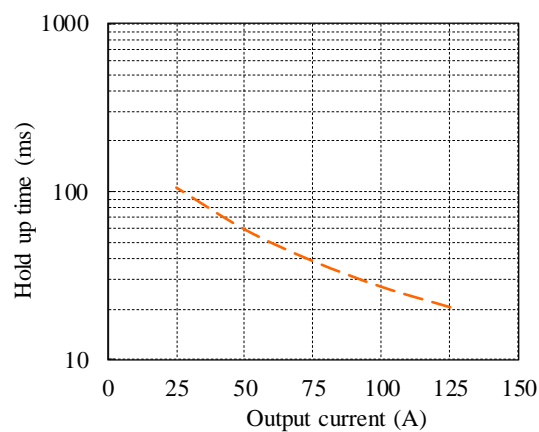

2-1-4. 出力電圧立ち上がり特性 Output voltage rise characteristics

Conditions Vin : 200 VAC (A)
 230 VAC (B)
 Iaux : 100 %
 Ta : 25 °C

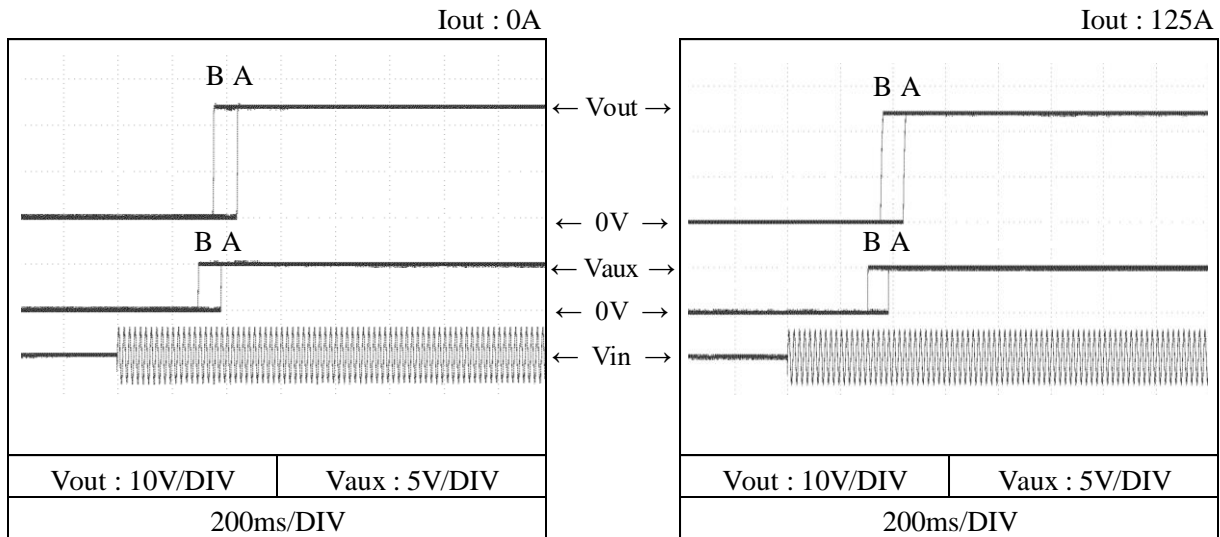

2-1-5. 出力電圧立ち下がり特性 Output voltage fall characteristics

Conditions Vin : 200 VAC (A)
 230 VAC (B)
 Iaux : 100 %
 Ta : 25 °C

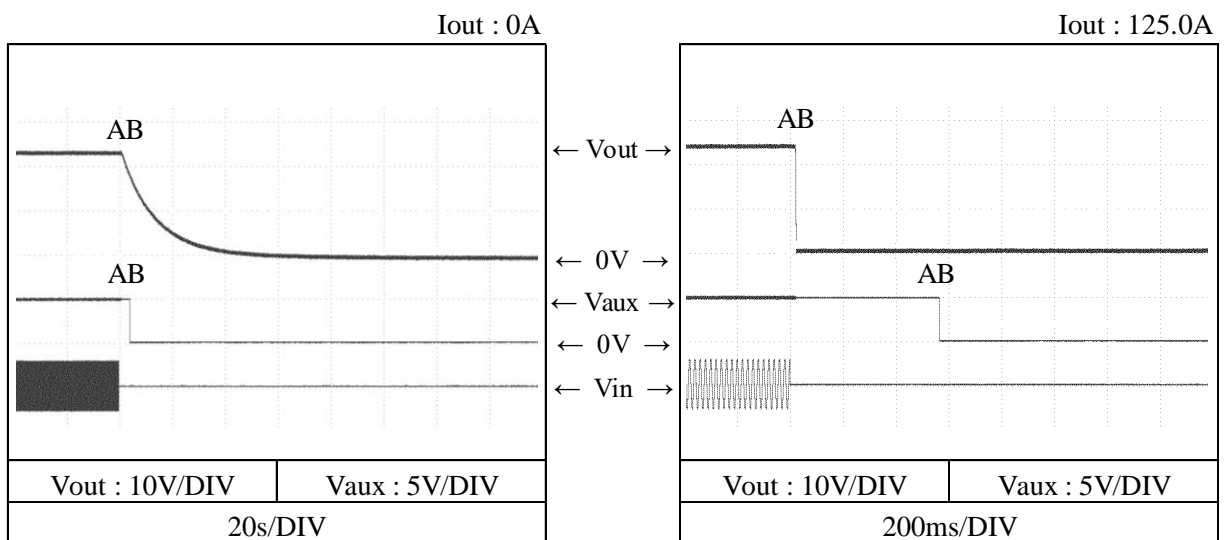

2-1-6. ON/OFFコントロール時出力立ち上がり、立ち下がり特性

Output rise, fall characteristics with ON/OFF Control

(a) リモートON/OFFコントロール端子によるON/OFF

ON/OFF control by remote ON/OFF control terminal

Conditions V_{in} : 200 VAC

T_a : 25 °C

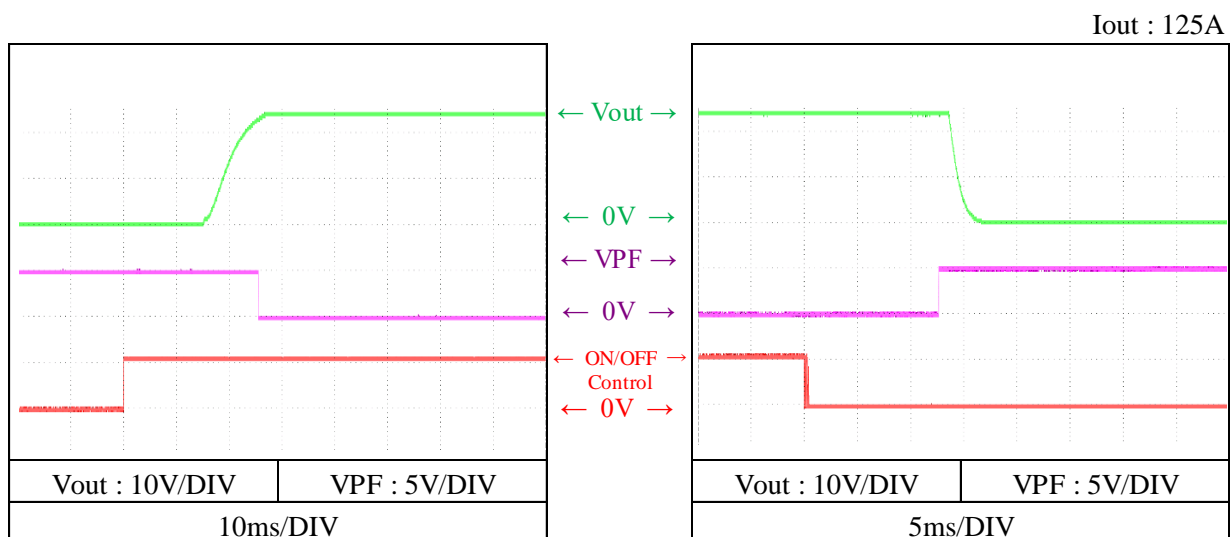
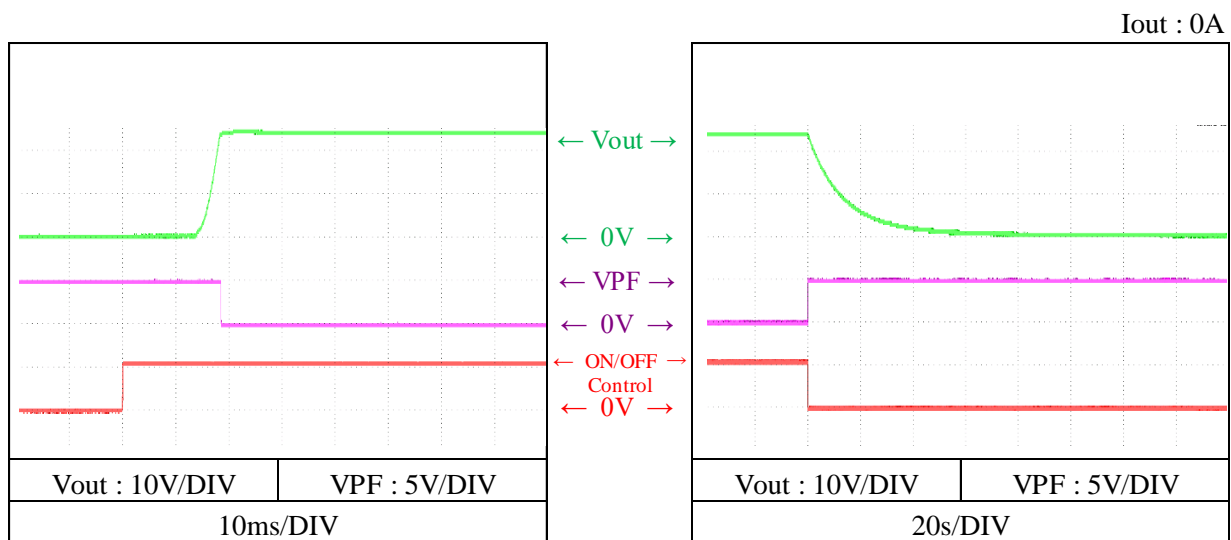

2-1-6. ON/OFFコントロール時出力立ち上がり、立ち下がり特性

Output rise, fall characteristics with ON/OFF Control

(b) RS-485通信によるON/OFF ON/OFF control by RS-485

Conditions V_{in} : 200 VAC

T_a : 25 °C

I_{out} : 0A

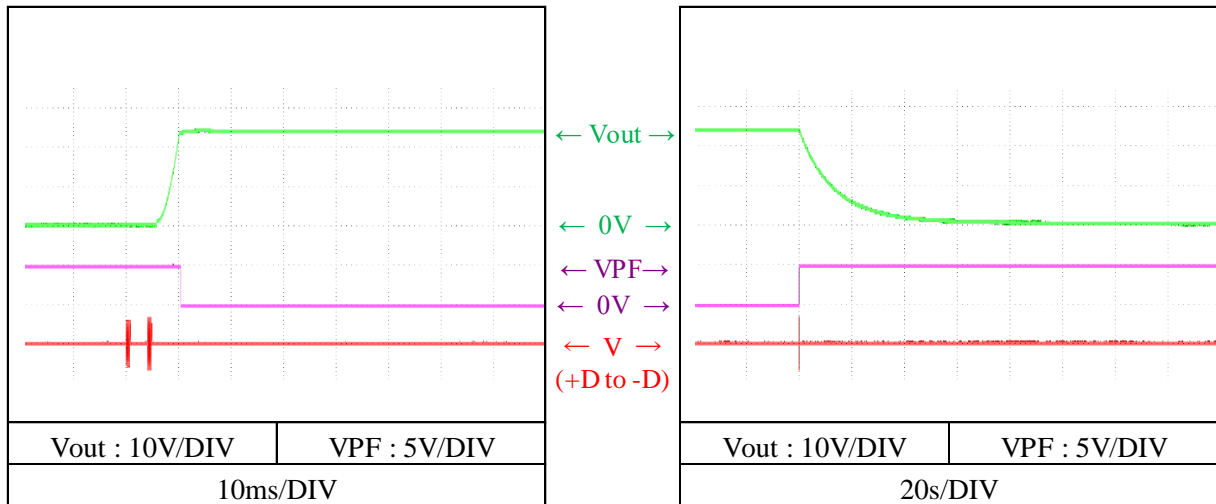

I_{out} : 125A

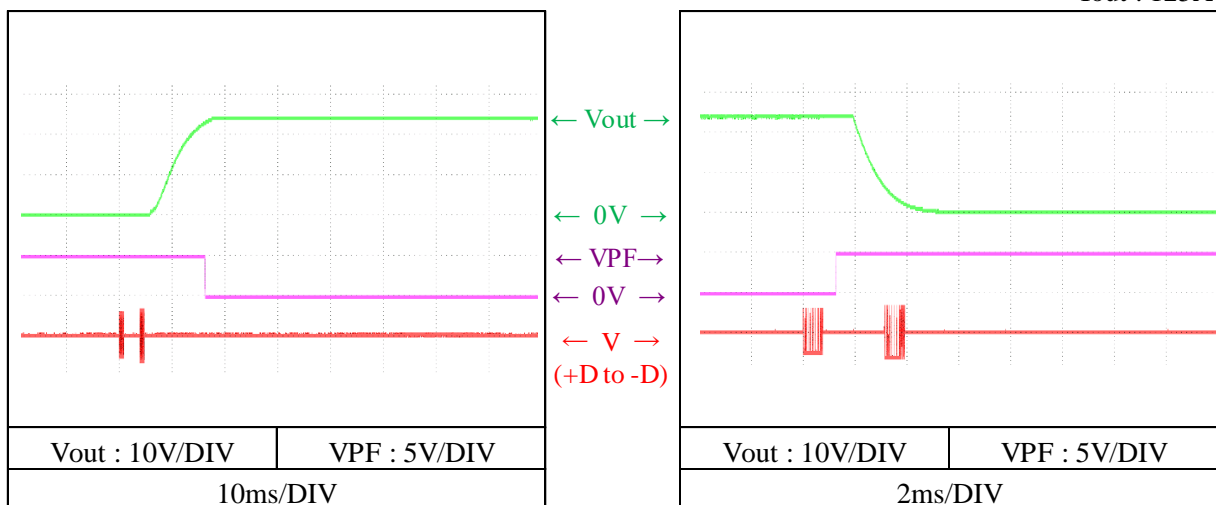

2-1-7. 過渡応答（負荷急変）特性 Dynamic load response characteristics

Conditions V_{in} : 200 VAC
 I_{out} : 62.5A \leftrightarrow 125A
 (tr = tf = 50us)
 T_a : 25 °C

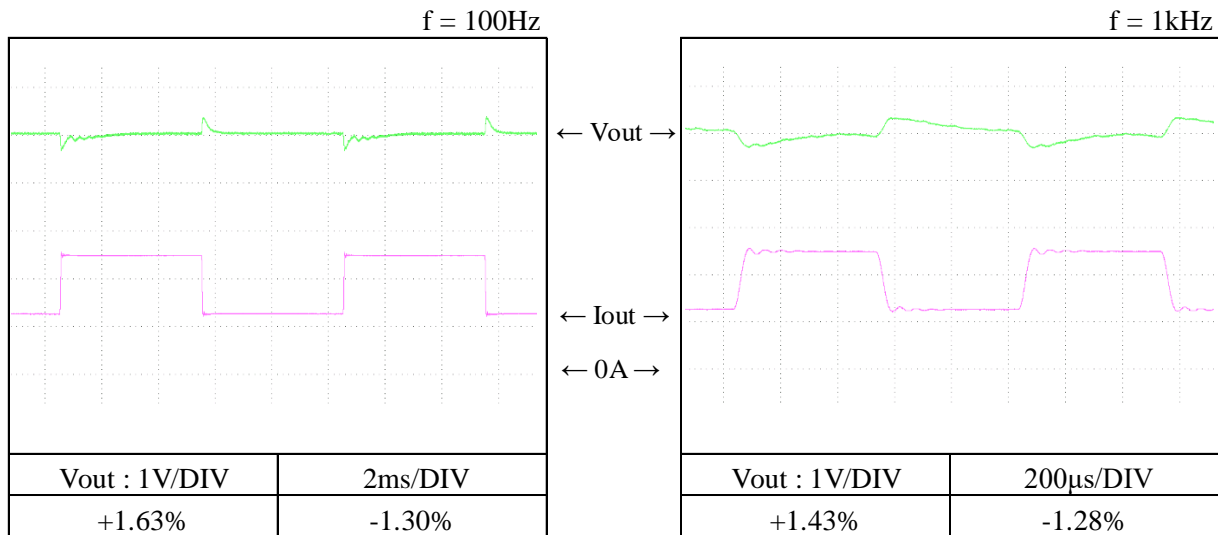

2-1-8. 入力電圧瞬停特性 Response to brown out characteristics

瞬停時間 Interruption time

- A : 出力電圧の低下なし Output voltage does not drop.
- B : 出力電圧の低下が0Vまでいかない Output voltage drop down not reaching 0V.
- C : 出力電圧が0Vまで低下 Output voltage drops until 0V.

Conditions V_{in} : 200 VAC
 I_{out} : 125 A
 T_a : 25 °C

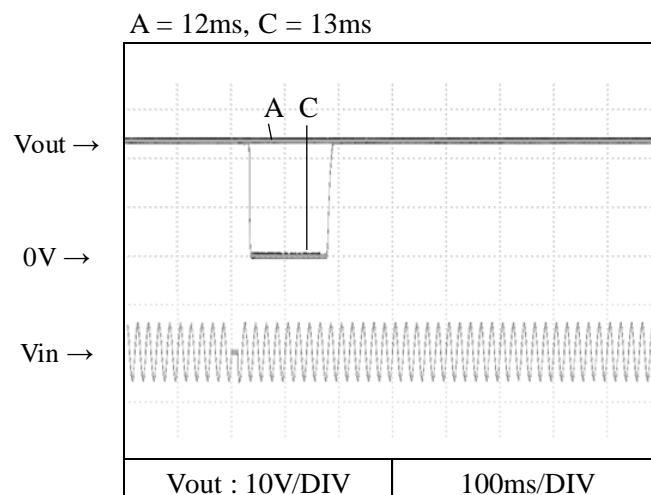

2-1-9. 出力リップル、ノイズ波形 Output ripple and noise waveform

Conditions Vin : 200 VAC

Vout : 24 V

Iout : 125 A

Ta : 25 °C

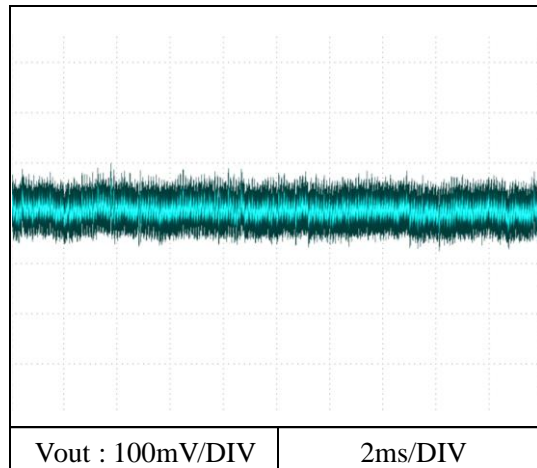

2-2. 定電流出力モード Constant current output mode

2-2-1. 静特性 Steady state data

(1) 入力・負荷・温度変動 Regulation - line and load, Temperature drift

1. Regulation - line and load

Condition Ta : 25 °C

Vout \ Vin	170VAC	200VAC	230VAC	265VAC	Line regulation	
2.4V	125.39A	125.39A	125.38A	125.38A	18mA	0.014%
12V	125.34A	125.35A	125.34A	125.34A	12mA	0.010%
24V	125.38A	125.38A	125.35A	125.38A	26mA	0.021%
Load regulation	49mA	47mA	32mA	47mA		
	0.039%	0.038%	0.026%	0.038%		

2. Temperature drift

Conditions Vin : 200 VAC
Vout : 24 V

Ta	-20°C	+25°C	+50°C	Temperature stability	
Iout	124.81A	125.38A	125.87A	1066mA	0.853%

(2) リップルノイズ電流対出力電圧 Ripple noise current vs. Output voltage

Conditions

Vin : 200 VAC

Iout : 125 A

Ta : -20 °C ---

25 °C ---

50 °C ---

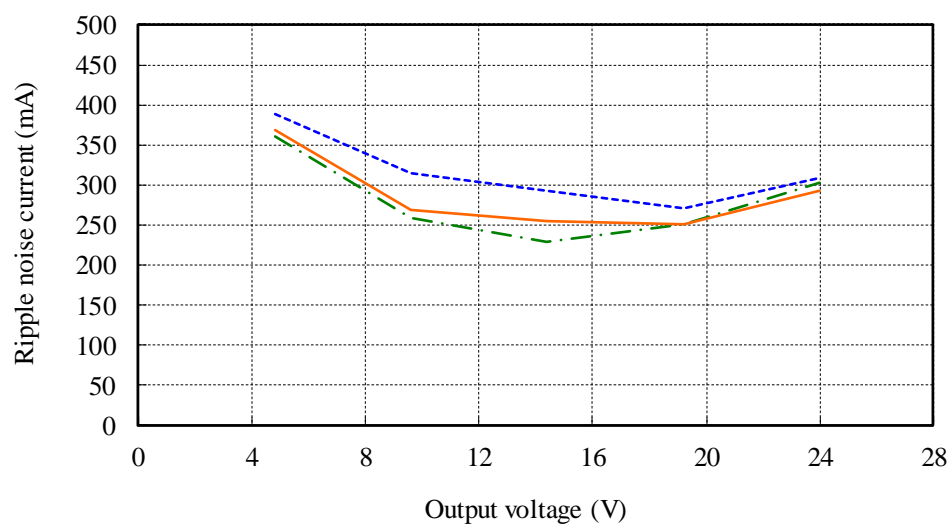

(3) 効率・力率対出力電圧 Efficiency and Power factor vs. Output voltage

Conditions Vin : 200 VAC ———
 230 VAC - - -
 Iout : 125 A
 Iaux : 0 %
 Ta : 25 °C

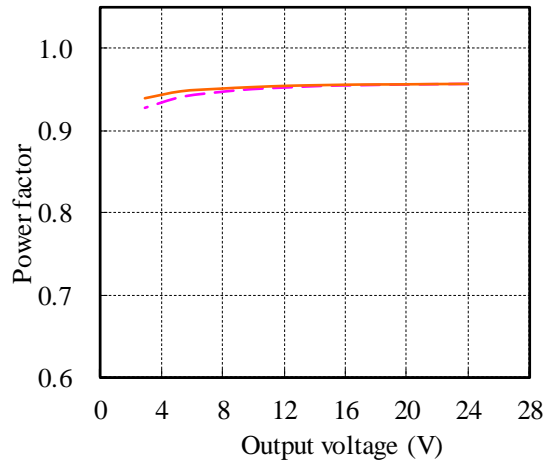
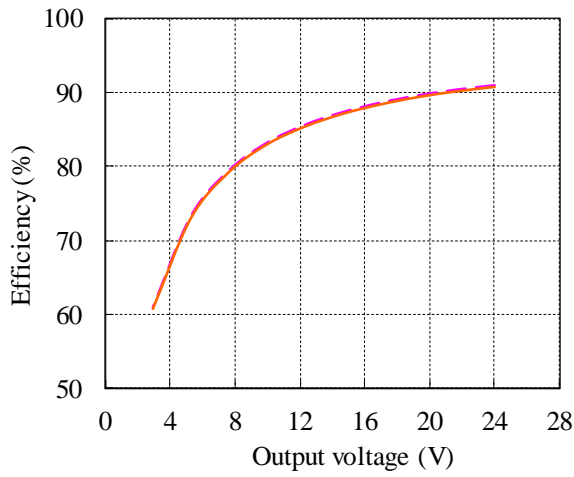

(4) 入力電力対出力電圧 Input power vs. Output voltage

Conditions Vin : 200 VAC ———
 230 VAC - - -
 Iout : 125 A
 Iaux : 0 %
 Ta : 25 °C

Vin	Input power
	Control OFF
200VAC	7.0W
230VAC	7.0W

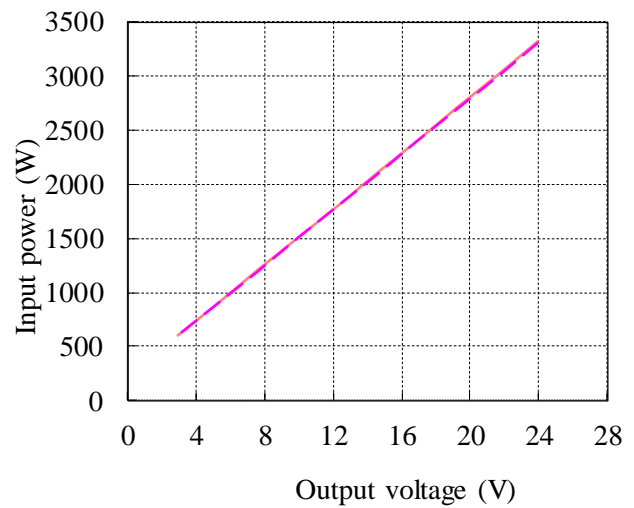

(5) 入力電流対出力電圧 Input current vs. Output voltage

Conditions Vin : 200 VAC ———
 230 VAC - - - -
 Iout : 125 A
 Iaux : 0 %
 Ta : 25 °C

Vin	Input current
	Control OFF
200VAC	0.22A
230VAC	0.25A

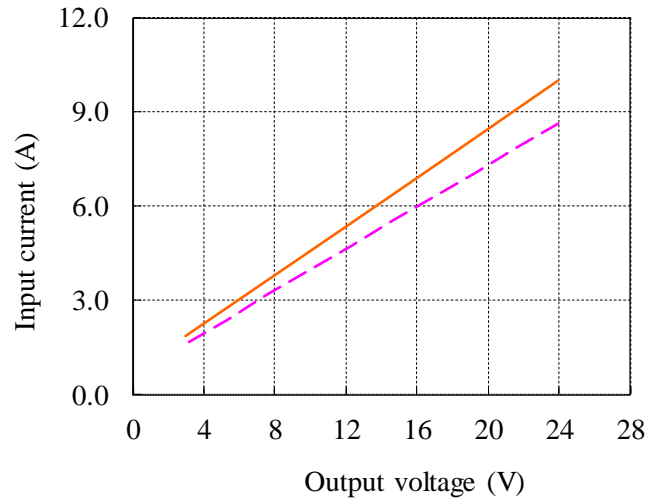

2-2-2. 通電ドリフト特性 Warm up current drift characteristics

Conditions V_{in} : 200 VAC
 V_{out} : 24 V
 I_{out} : 125 A
 T_a : 25 °C

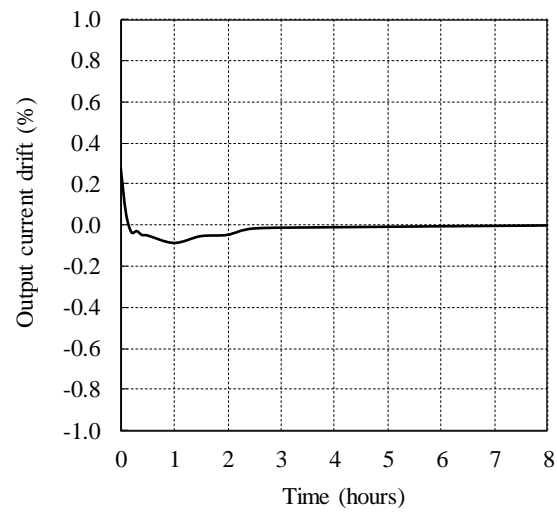

2-2-3. 出力電流立ち上がり特性 Output current rise characteristics

Conditions Vin : 200 VAC (A)
 230 VAC (B)
 Vout : 24 V
 Iaux : 100 %
 Ta : 25 °C

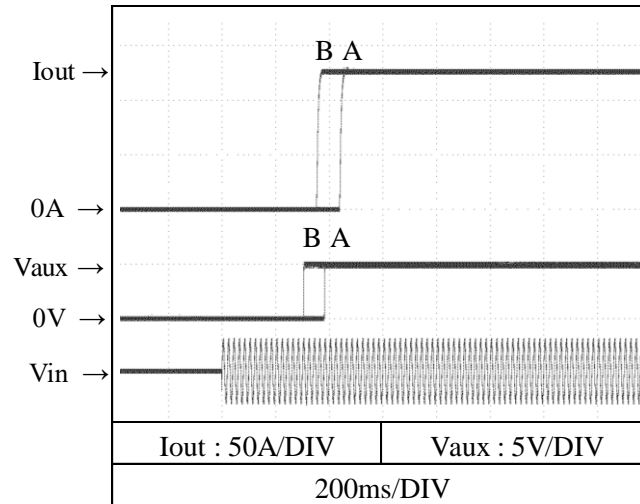

2-2-4. 出力電流立ち下がり特性 Output current fall characteristics

Conditions Vin : 200 VAC (A)
 230 VAC (B)
 Vout : 24 V
 Iaux : 100 %
 Ta : 25 °C

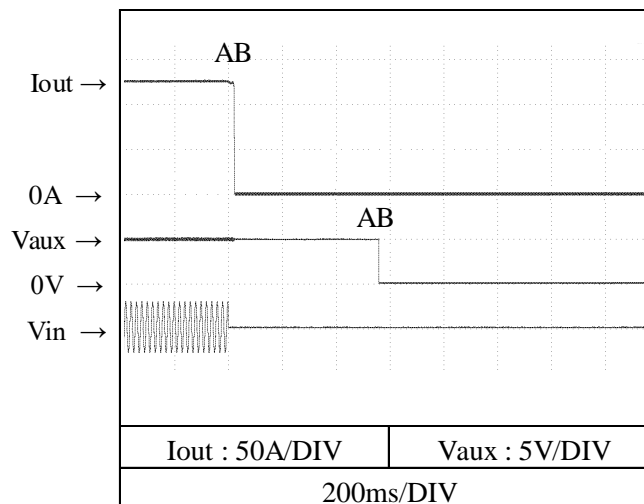

2-2-5. ON/OFFコントロール時出力立ち上がり、立ち下がり特性

Output rise, fall characteristics with ON/OFF Control

(a) リモートON/OFFコントロール端子によるON/OFF

ON/OFF control by remote ON/OFF control terminal

Conditions Vin : 200 VAC

Vout : 24 V

Ta : 25 °C

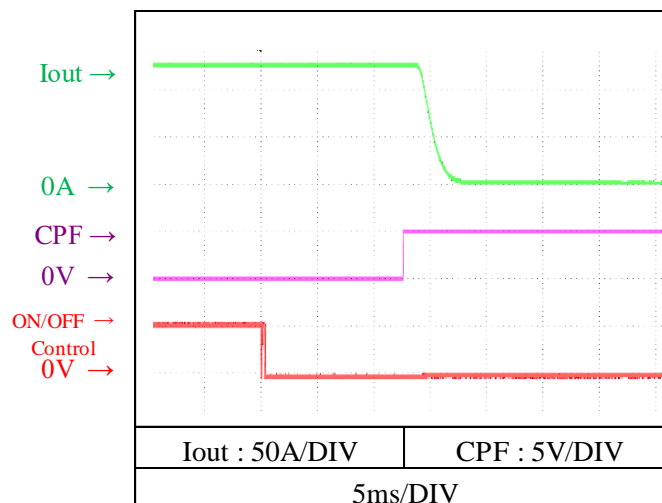
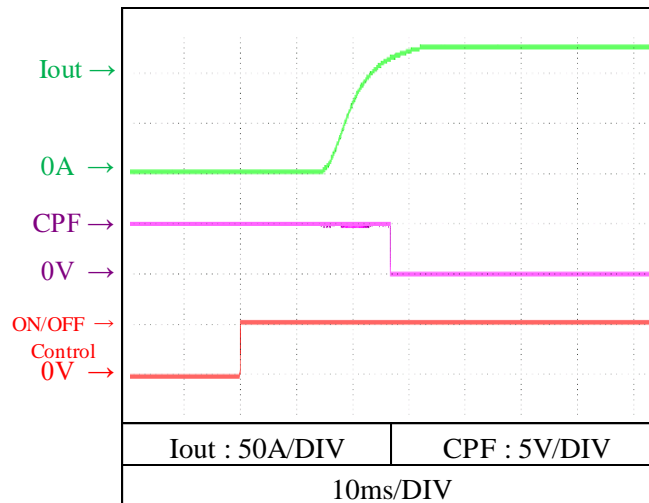

2-2-5. ON/OFFコントロール時出力立ち上がり、立ち下がり特性

Output rise, fall characteristics with ON/OFF Control

(b) RS-485通信によるON/OFF ON/OFF control by RS-485

Conditions Vin : 200 VAC

Vout : 24 V

Ta : 25 °C

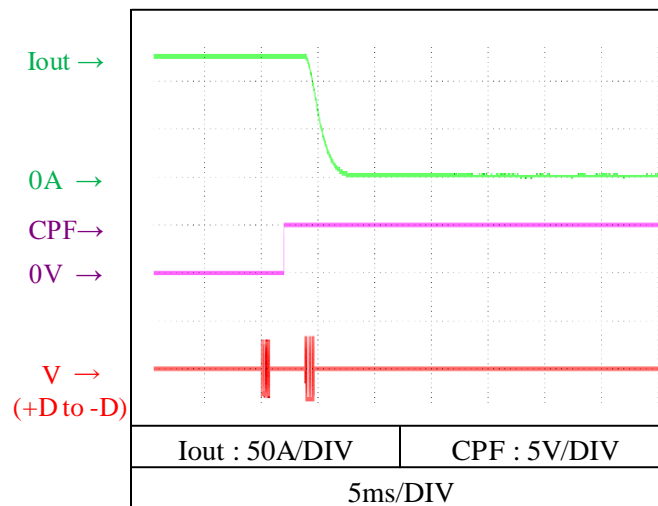
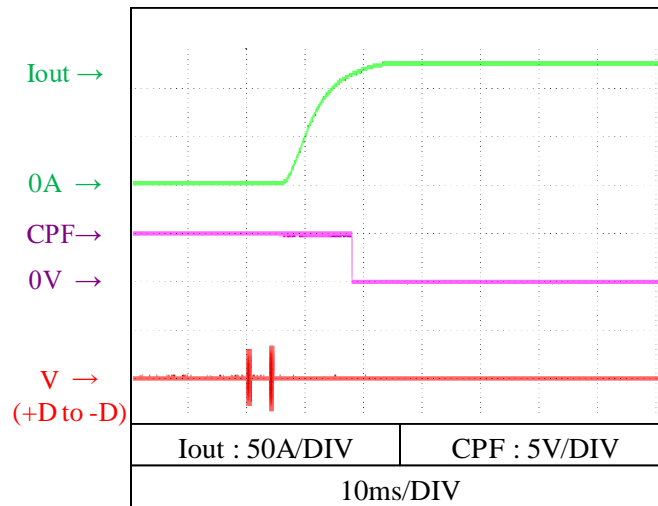

2-2-6. 入力電圧瞬停特性 Response to brown out characteristics

瞬停時間 Interruption time

A : 出力電圧の低下なし Output voltage does not drop.

B : 出力電圧の低下が0Vまでいかない Output voltage drop down not reaching 0V.

C : 出力電圧が0Vまで低下 Output voltage drops until 0V.

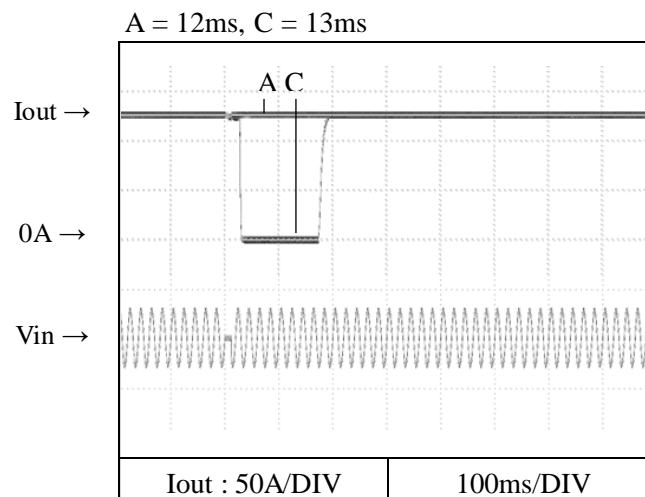
Conditions V_{in} : 200 VAC V_{out} : 24 V T_a : 25 °C

2-2-7. 出力リップル、ノイズ波形 Output ripple and noise waveform

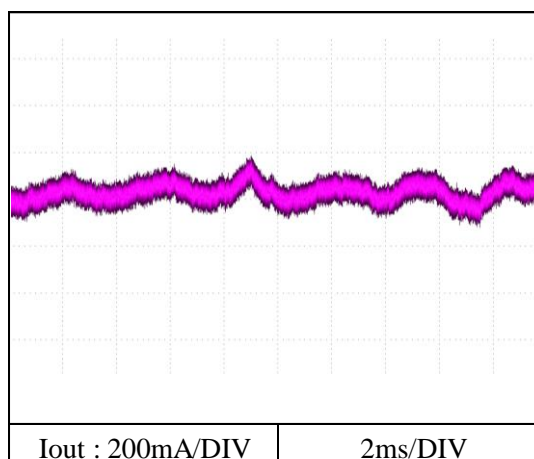
Conditions V_{in} : 200 VAC V_{out} : 24 V I_{out} : 125 A T_a : 25 °C

2-3. 過電流保護特性 Over current protection (OCP) characteristics

Conditions V_{in} : 200 VAC
 T_a : -20 °C ---
 25 °C ———
 50 °C - · - ·

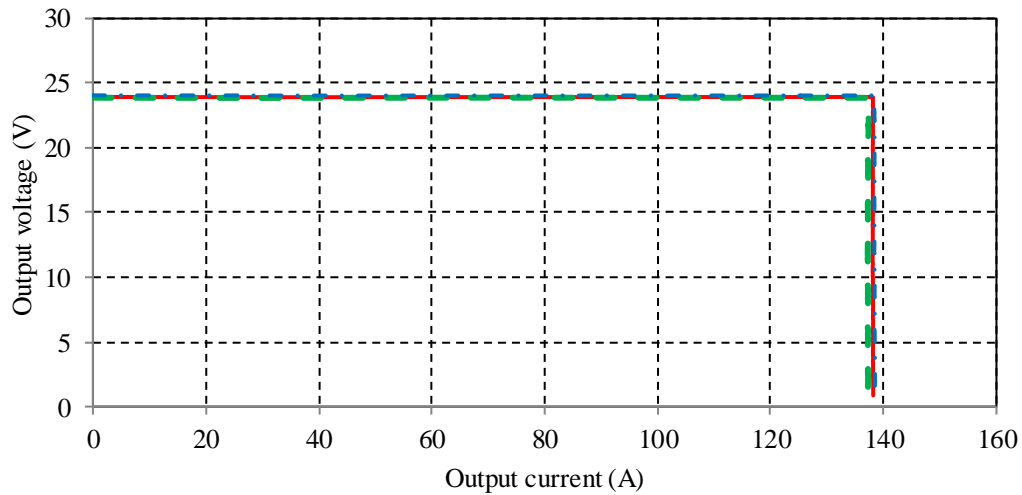

2-4. 過電壓保護特性 Over voltage protection (OVP) characteristics

Conditions V_{in} : 200 VAC
 I_{out} : 1 A
 T_a : 25 °C

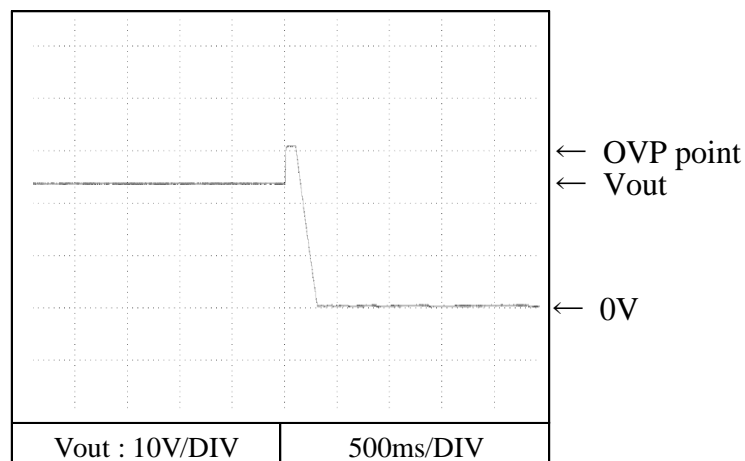

2-5. 入力サージ電流（突入電流）波形 Inrush current waveform

Conditions V_{in} : 200 VAC

V_{out} : Nominal output voltage

I_{out} : Maximum output current

T_a : 25 °C

Switch on phase angle of input AC voltage
 $\phi = 0^\circ$

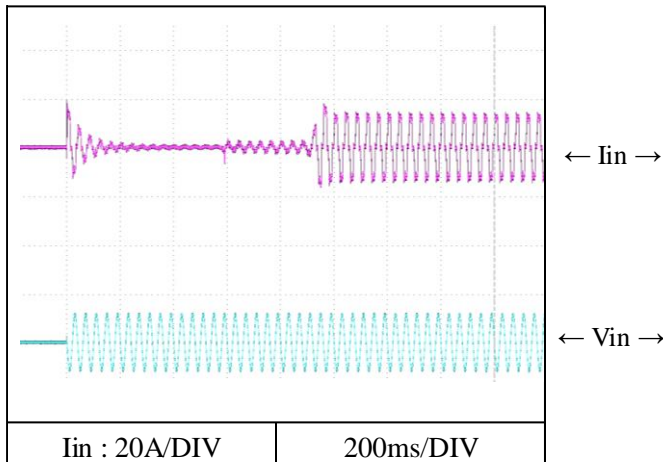

Switch on phase angle of input AC voltage
 $\phi = 90^\circ$

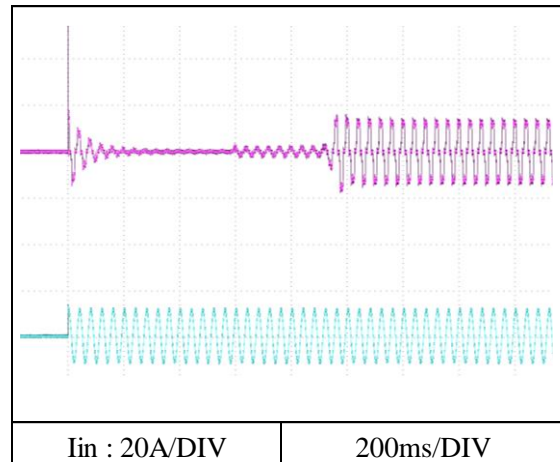

2-6. 入力電流波形 Input current waveform

Conditions V_{in} : 200 VAC

V_{out} : Nominal output voltage

I_{out} : Maximum output current

T_a : 25 °C

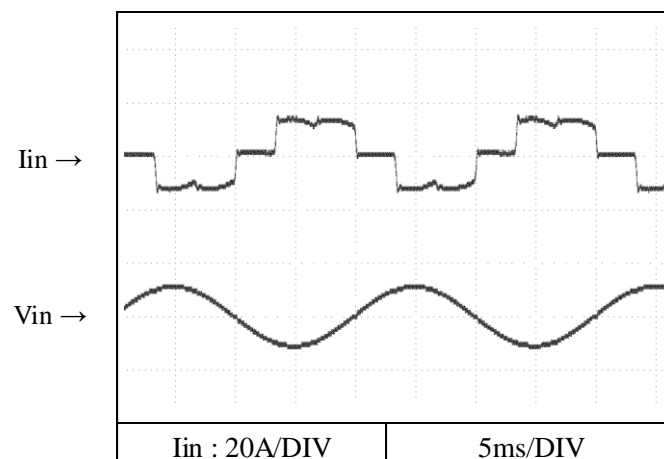

2-7. リーク電流特性 Leakage current characteristics

Conditions Vout : Nominal output voltage
 Iout : 0 A ——— (Blue)
 Maximum - - - - (Orange)
 Ta : 25 °C
 f : 50 Hz

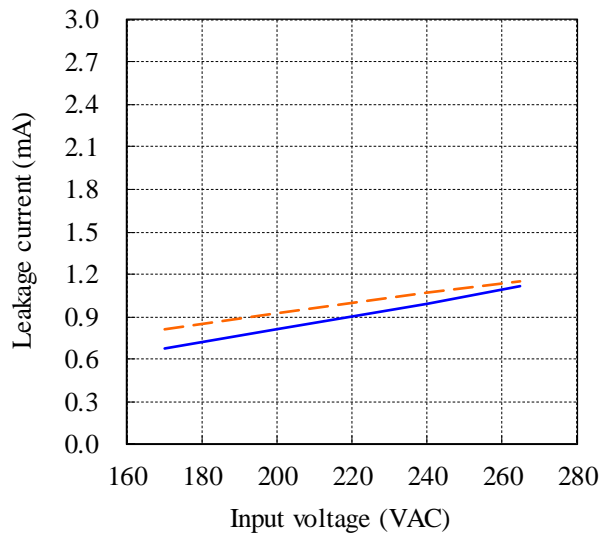

Conditions Vout : Nominal output voltage
 Iout : 0 A ——— (Blue)
 Maximum - - - - (Orange)
 Ta : 25 °C
 f : 60 Hz

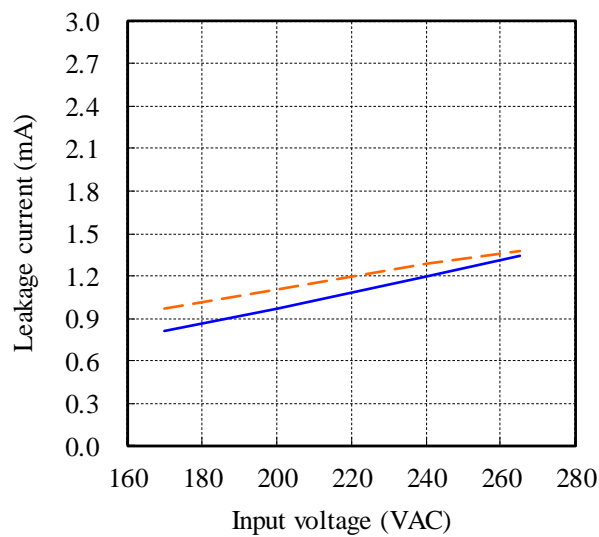

2-8. EMI特性 Electro Magnetic Interference characteristics

雑音端子電圧
Conducted Emission

Conditions Vin : 200 VAC
Vout : 24 V
Iout : 125 A
Iaux : 100 %
Ta : 25 °C

Phase : L1

Point A (0.24MHz)		
Ref. Data	Limit (dB)	Measure (dB)
QP	79.0	55.9
AV	66.0	53.1

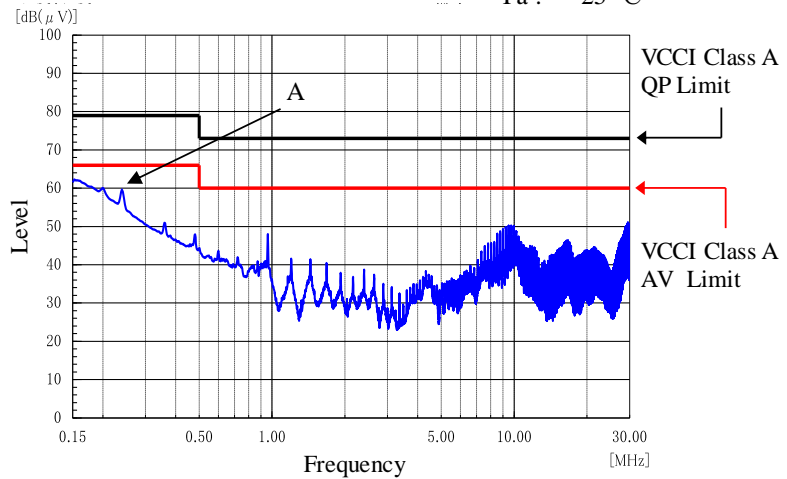

Phase : L2

Point B (0.24MHz)		
Ref. Data	Limit (dB)	Measure (dB)
QP	79.0	57.6
AV	66.0	55.4

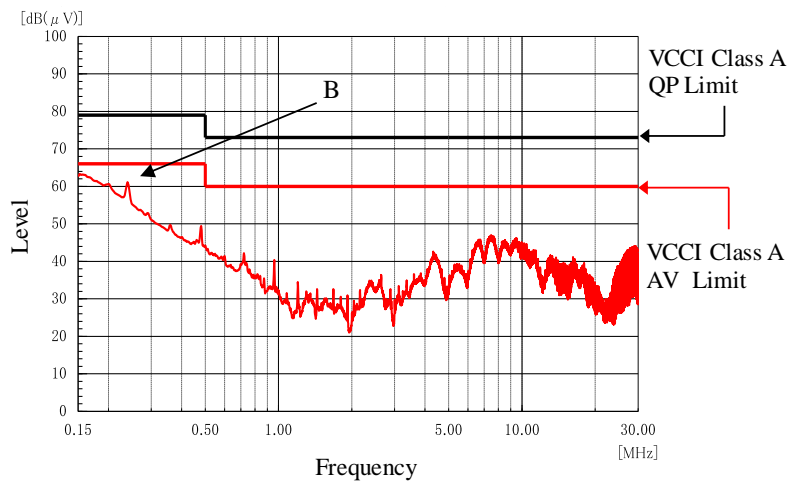

Phase : L3

Point C (0.24MHz)		
Ref. Data	Limit (dB)	Measure (dB)
QP	79.0	61.0
AV	66.0	59.9

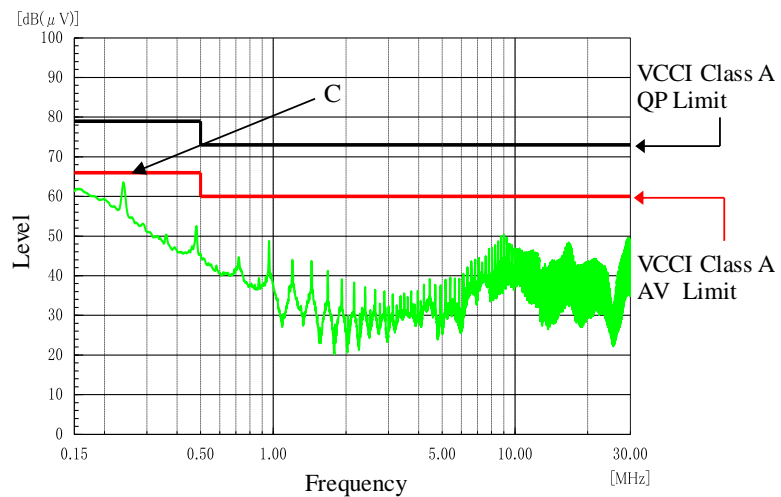

EN55011-A,EN55032-A,FCC-Aの限界値はVCCI class Aの限界値と同じ
Limit of EN55011-A,EN55032-A,FCC-A are same as its VCCI class A.

波形はピーク値

Waveform is peak values.

2-8. EMI特性 Electro Magnetic Interference characteristics

雑音電界強度
Radiated Emission

Conditions Vin : 200 VAC
Vout : 24 V
Iout : 125 A
Iaux : 100 %
Ta : 25 °C

HORIZONTAL

Point A (140MHz)		
Ref.	Limit	Measure
Data	(dB)	(dB)
QP	50.0	40.9

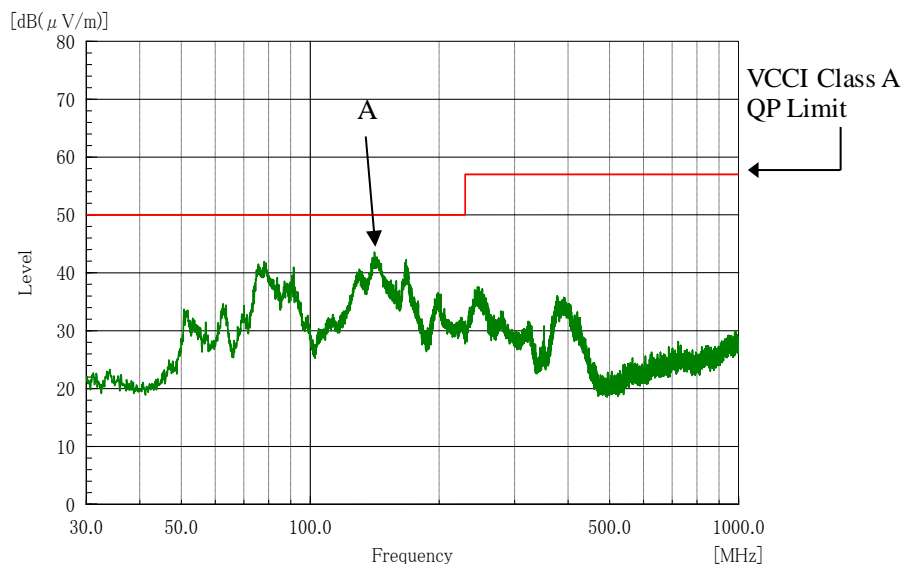

VERTICAL

Point B (76MHz)		
Ref.	Limit	Measure
Data	(dB)	(dB)
QP	50.0	43.2

Point C (139MHz)		
Ref.	Limit	Measure
Data	(dB)	(dB)
QP	50.0	45.8

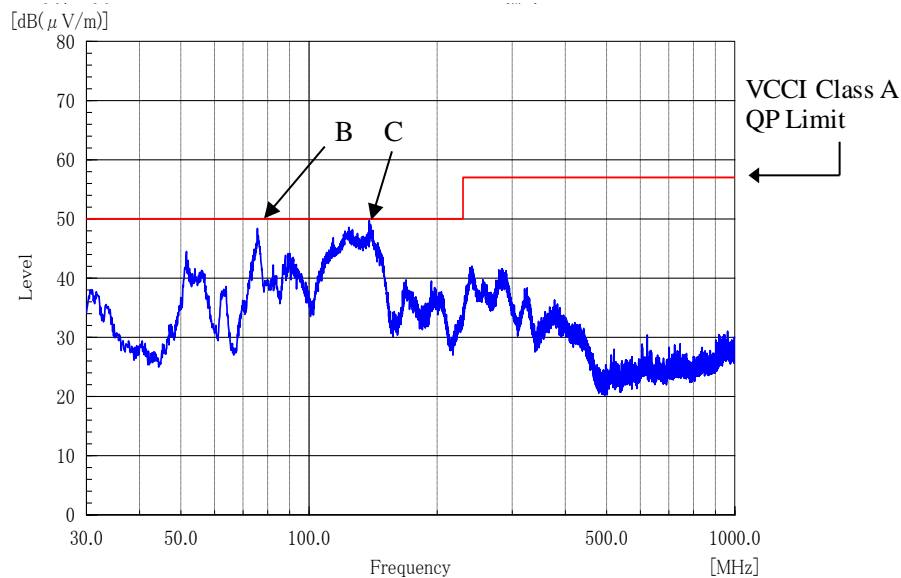

EN55011-A,EN55032-A,FCC-Aの限界値はVCCI class Aの限界値と同じ
Limit of EN55011-A,EN55032-A,FCC-A are same as its VCCI class A.
波形はピーク値
Waveform is peak values.