

# JWS70P

## EVALUATION DATA

### 型式データ

DWG No. A180-53-01			
QA APPD	APPD	CHK	DWG
<i>S. Murayama</i> 3/sep. 99	<i>[Signature]</i> 23/Aug/99	<i>S. Koyama</i> 23/Aug/99	<i>[Signature]</i> 21/Aug/99

## INDEX

1. 測定方法	Evaluation Method	PAGE
1.1	測定回路 Circuit used for determination .....	T-1~5
	(1) 静特性 Steady state data	
	(2) 通電ドリフト特性 Warm up voltage drift characteristics	
	(3) 過電流保護特性 Over current protection (OCP) characteristics	
	(4) 過電圧保護特性 Over voltage protection (OVP) characteristics	
	(5) 出力立ち上がり特性 Output rise characteristics	
	(6) 出力立ち下がり特性 Output fall characteristics	
	Output fall characteristics with ON/OFF CONTROL	
	(7) 過渡応答 (入力急変) 特性 Dynamic line response characteristics	
	(8) 過渡応答 (負荷急変) 特性 Dynamic load response characteristics	
	(9) 入力サージ電流 (突入電流) 特性 Inrush current characteristics	
	(10) リーク電流特性 Leakage current characteristics	
	(11) 出力リップル、ノイズ波形 Output ripple and noise waveform	
	(12) EMI特性 Electro-Magnetic Interference characteristics	
1.2	使用測定機器 List of equipment used .....	T-6
2.	特性データ Characteristics	
2.1	静特性 Steady state data	
	(1) 入力・負荷・温度変動	
	Regulation - line and load, temperature drift .....	T-7
	(2) 出力電圧・リップル電圧対入力電圧	
	Output voltage and ripple voltage vs. input voltage .....	T-8
	(3) 効率・入力電流対出力電流	
	Efficiency and input current vs. output current .....	T-9
	(4) 力率・入力電流対出力電流	
	Power factor and input current vs. output current .....	T-10
2.2	通電ドリフト特性 Warm up voltage drift characteristics .....	T-11
2.3	過電流保護特性 Over current protection (OCP) characteristics .....	T-12
2.4	過電圧保護特性 Over voltage protection (OVP) characteristics .....	T-13
2.5	出力立ち上がり特性 Output rise characteristics .....	T-14~15
2.6	出力立ち下がり特性 Output fall characteristics .....	T-16~17
2.7	出力保持時間特性 Hold up time characteristics .....	T-18
2.8	過渡応答 (入力急変) 特性 Dynamic line response characteristics ....	T-19
2.9	過渡応答 (負荷急変) 特性 Dynamic load response characteristics ...	T-20~21
2.10	入力電圧瞬停特性 Response to brown out characteristics .....	T-22~23

2.11	入力サージ電流 (突入電流) 特性	Inrush current waveform	.....	T-24~25
2.12	瞬停時突入電流特性	Inrush current characteristics	.....	T-26
2.13	入力電流波形	Input current waveform	.....	T-27
2.14	高調波成分	Input current harmonics	.....	T-28
2.15	リーク電流特性	Leakage current characteristics	.....	T-29~30
2.16	出力リップル、ノイズ波形	Output ripple and noise waveform	.....	T-31~32
2.17	EMI特性	Electro-Magnetic Interference characteristics	.....	T-33~35

**使用記号 Terminology used**

	Definition	
Vin	..... 入力電圧	Input voltage
Vout	..... 出力電圧	Output voltage
Iin	..... 入力電流	Input current
Iout	..... 出力電流	Output current
f	..... 周波数	Frequency
Ta	..... 周囲温度	Ambient temperature

1. 1

測定回路

**Circuit used for determination**

(1) 静特性

Steady state data

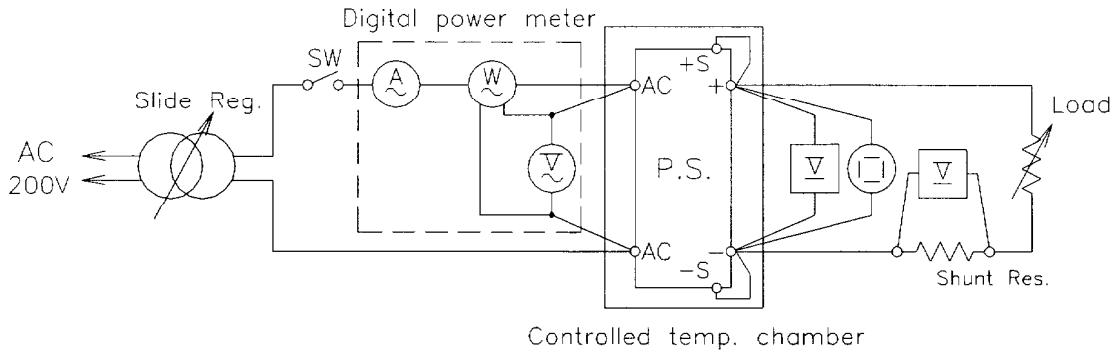

(2) 通電ドリフト特性

Warm up voltage drift characteristics

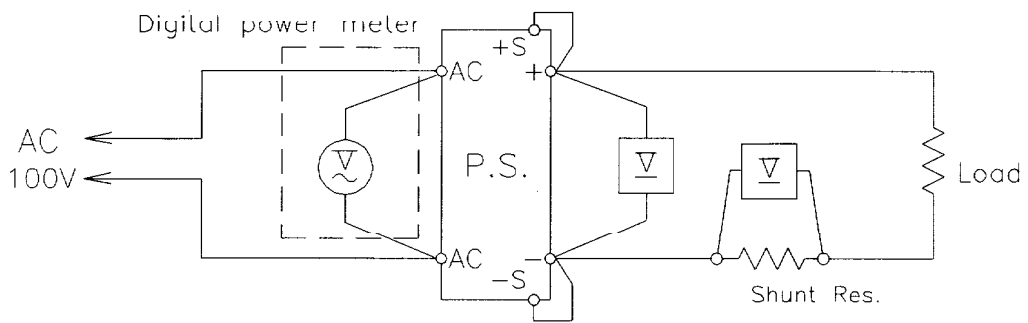

(3) 過電流保護特性

Over current protection (O.C.P.) characteristics

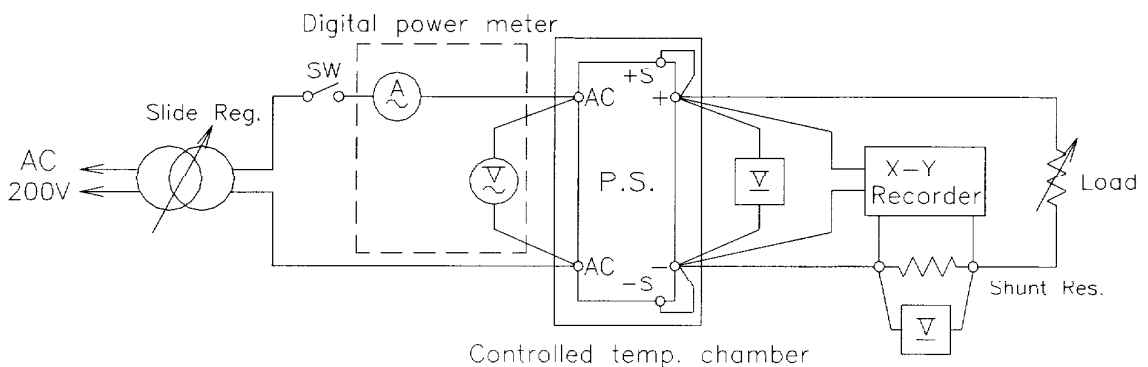

(4) 過電圧保護特性

Over voltage protection (O.V.P.) characteristics

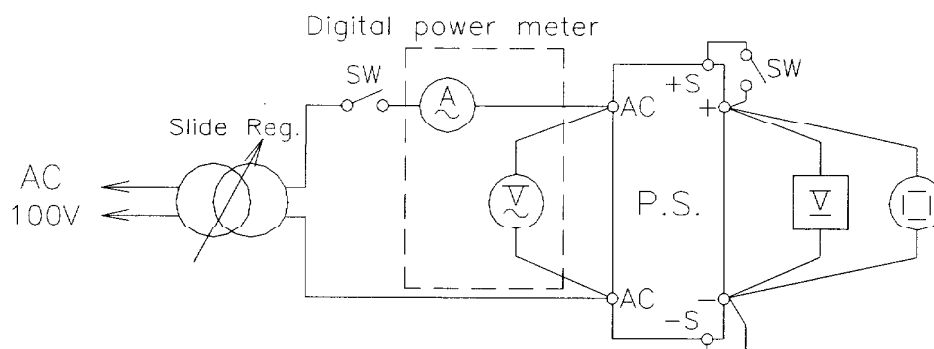

(5) 出力立ち上がり特性

Output rise characteristics

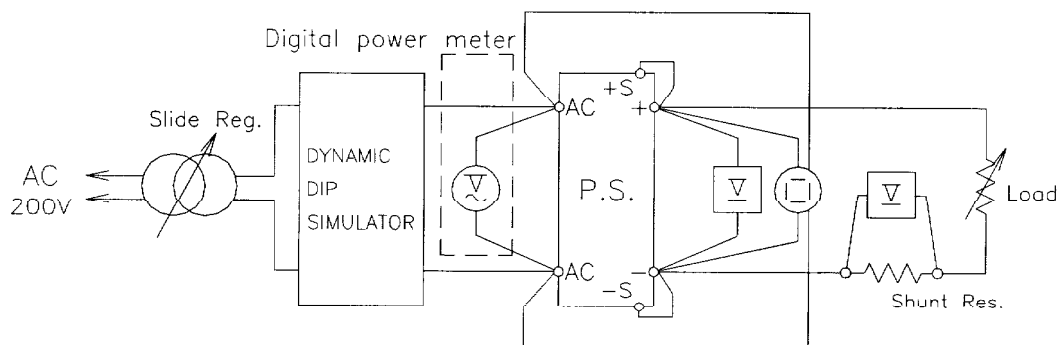

(6) 出力立ち下がり特性

Output fall characteristics

Same as output rise characteristics

(7) 過渡応答 (入力急変)

Dynamic line response characteristics

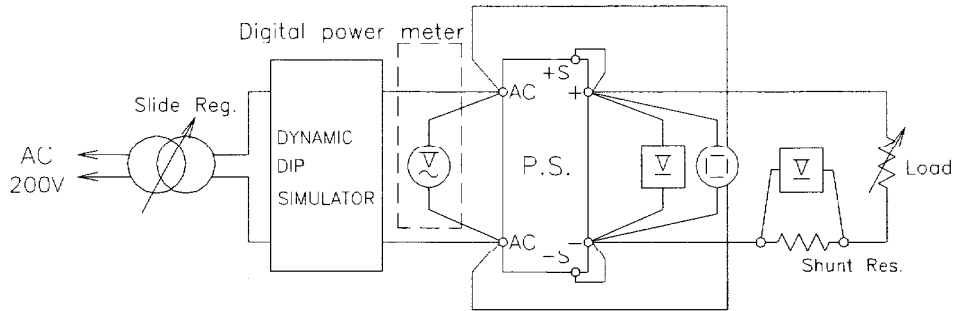

(8) 過渡応答 (負荷急変) 特性

Dynamic load response characteristics

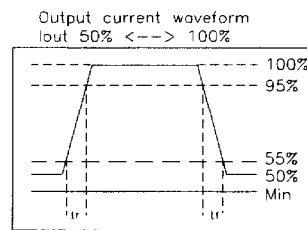
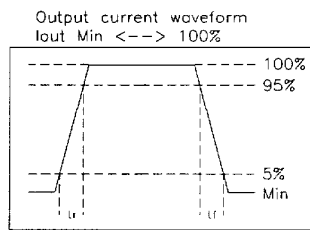
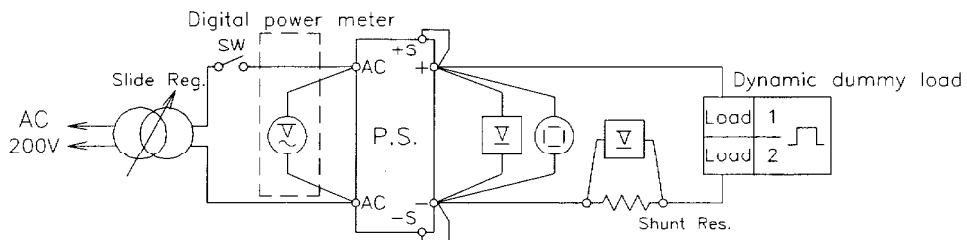

(9) 入力サージ電流 (突入電流) 特性

Inrush current characteristics

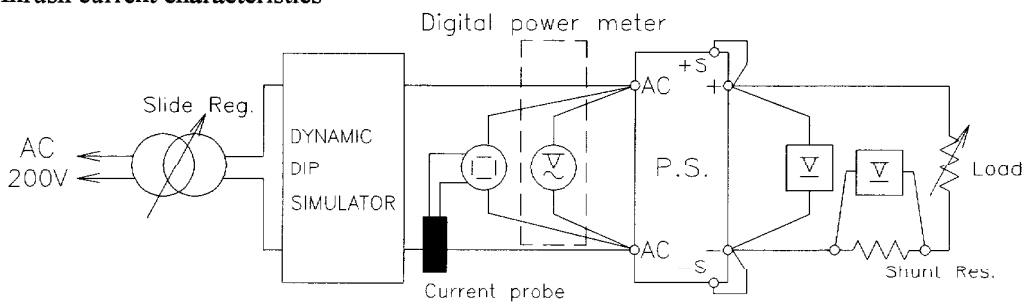

(10) リーク電流

Leakage current characteristics

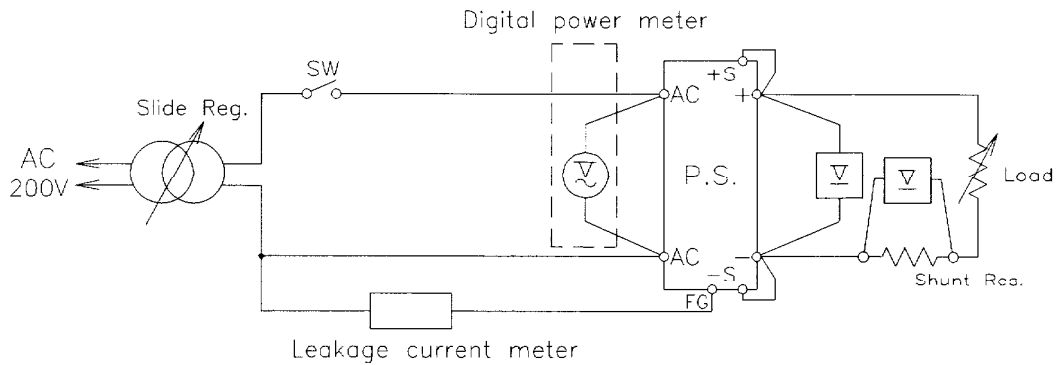

NOTE : Leakage current measured through a 1kohm resistor.  
 Range used ---AC+DC (For YOKOGAWA TYPE 3226)  
 ---AC (For SIMPSON MODEL 229-2)

(11) 出力リップルノイズ

Output ripple noise

(a) Normal Mode

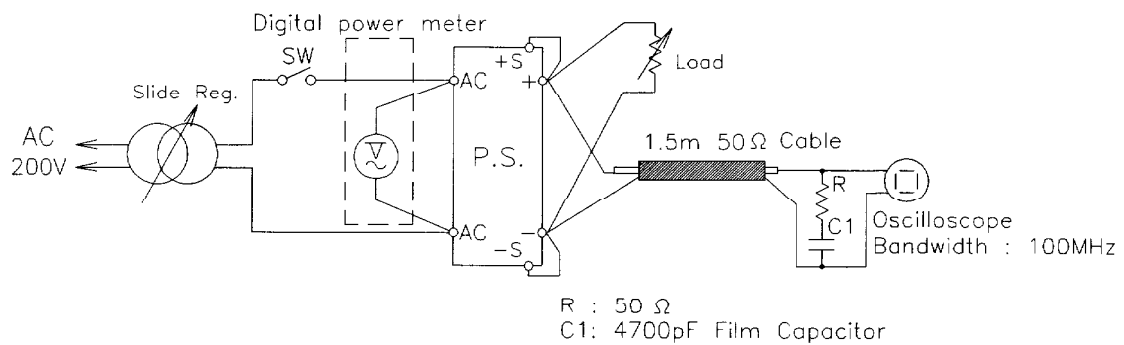

(b) Normal + Common Mode

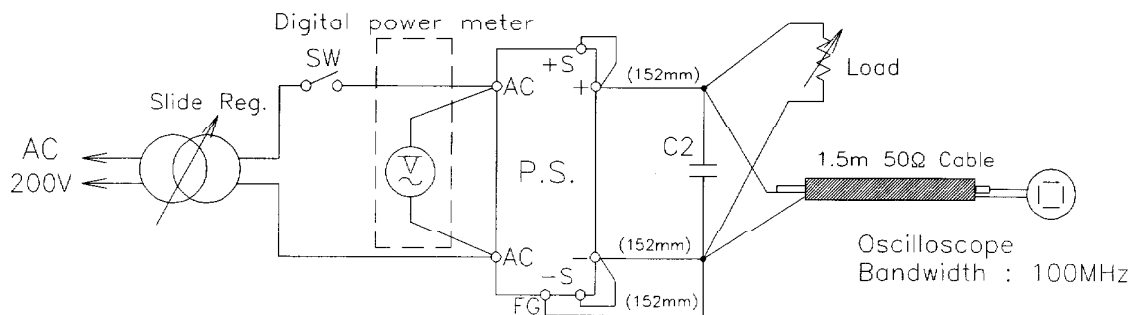

(12) EMI 特性

Electro-Magnetic Interference characteristics

(a) 雑音端子電圧 (帰還ノイズ)

Conducted Emission Noise

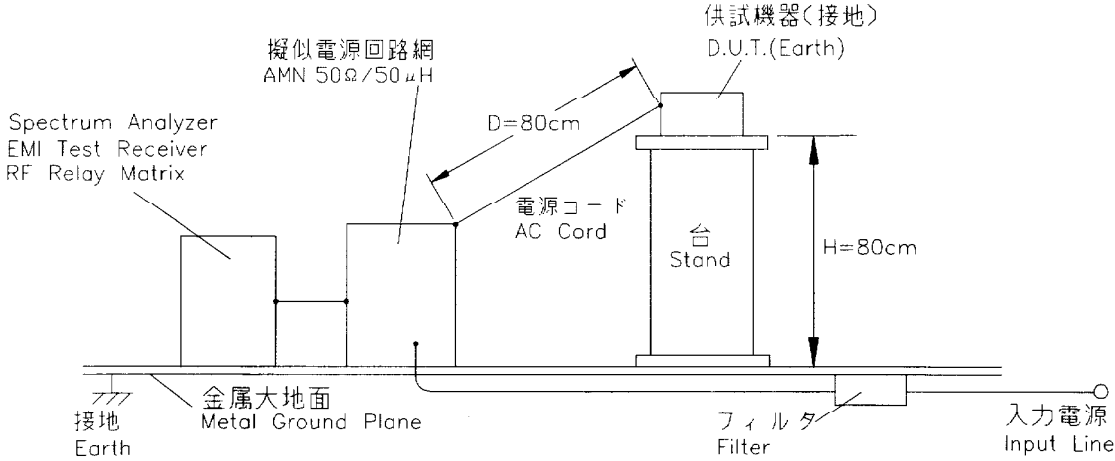

(b) 雑音電界強度 (輻射ノイズ)

Radiated Emission Noise

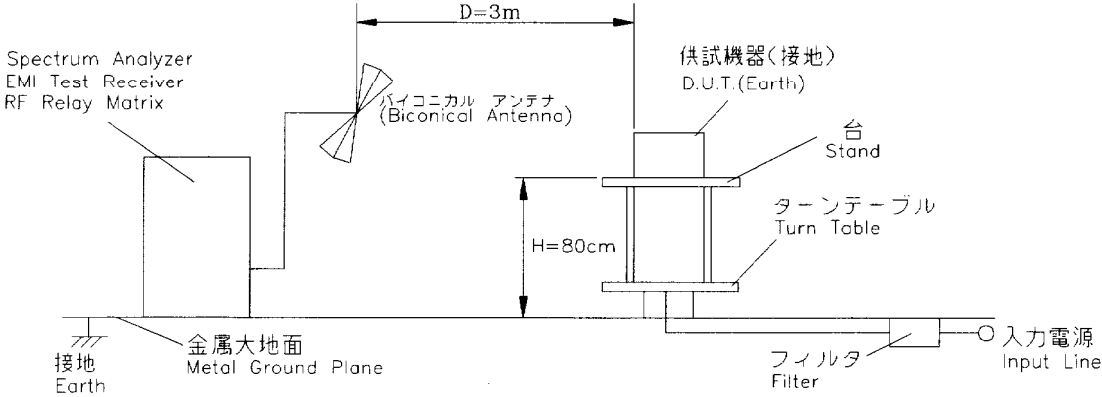



1.2 使用測定機器 LIST OF EQUIPMENT USED

	EQUIPMENT USED	MANUFACTURER	MODEL NO.
1	OSCILLOSCOPE	HITACHI DENSHI	V-1100A
2	DIGITAL STORAGE OSCILLOSCOPE	TEKTRONIX	TDS540B
3	DIGITAL MULTIMETER	ADVANTEST	R6341A
4	DIGITAL POWER METER	YOKOGAWA ELECT.	WT110
5	SHUNT RESISTOR	YOKOGAWA ELECT.	
6	CURRENT PROBE/AMPLIFIER	TEKTRONIX	A6303/AM503
7	DYNAMIC DUMMY LOAD	TAKASAGO	
8	SLIDE REGULATOR	MATSUNAGA	SD-2625
9	CVCF	KIKUSUI	PCR4000L
10	LEAKAGE CURRENT METER	SIMPSON	229-2
11	LEAKAGE CURRENT METER	YOKOGAWA	TYPE3226
12	X-Y RECORDER	GRAPHTEC	WX3000-1
13	DYNAMIC DIP SIMULATOR	TAKAMISAWA CYBERNETICS	PSA-300
14	CONTROLLED TEMP. CHAMBER	TABAI ESPEC	PSL-2KPH-A
15	SPECTRUM ANALYZER	ROHDE & SCHWARZ	FSA
16	EMI TEST RECEIVER	ROHDE & SCHWARZ	ESHS10
17	EMI TEST RECEIVER	ROHDE & SCHWARZ	ESVS10
18	RF RELAY MATRIX	ROHDE & SCHWARZ	PSU
19	AMN	KYORITSU DENSHI	KNW-242
20	ANTENNA(BICONICAL ANTENNA)	SCHWARZBECK	BBA9106

2. 特性データ Characteristics

2.1 静特性 Steady state data

(1) 入力、負荷、温度変動 Regulation - line and load, temperature drift

**24V**

1. Regulation - line and load

condition Ta : 25°C

Iout \ Vin	85VAC	100VAC	200VAC	265VAC	line regulation	
0%	23.96V	23.96V	23.96V	23.96V	0mV	0.000%
50%	23.94V	23.94V	23.94V	23.94V	0mV	0.000%
100%	23.94V	23.94V	23.94V	23.94V	0mV	0.000%
load	20mV	20mV	20mV	20mV		
regulation	0.08%	0.08%	0.08%	0.08%		

2. Temperature drift

conditions Vin=100VAC

Io =100%

Ta	-10°C	+25°C	+50°C	temperature stability	
Vo	23.95V	23.94V	23.88V	60mV	0.25%

**48V**

1. Regulation - line and load

condition Ta : 25°C

Iout \ Vin	85VAC	100VAC	200VAC	265VAC	line regulation	
0%	48.09V	48.09V	48.09V	48.09V	0mV	0.000%
50%	48.06V	48.06V	48.06V	48.06V	0mV	0.000%
100%	48.05V	48.05V	48.05V	48.05V	0mV	0.000%
load	40mV	40mV	40mV	40mV		
regulation	0.08%	0.08%	0.08%	0.08%		

2. Temperature drift

conditions Vin=100VAC

Io =100%

Ta	-10°C	+25°C	+50°C	temperature stability	
Vo	48.04V	48.05V	48.03V	20mV	0.04%

2.1 (2) 出力電圧、リップル電圧対入力電圧

Output voltage and Ripple voltage v.s. Input voltage

Conditions Iout : 100%

Ta : -10°C .....  
 : 25°C .....  
 : 50°C ——

**24V**

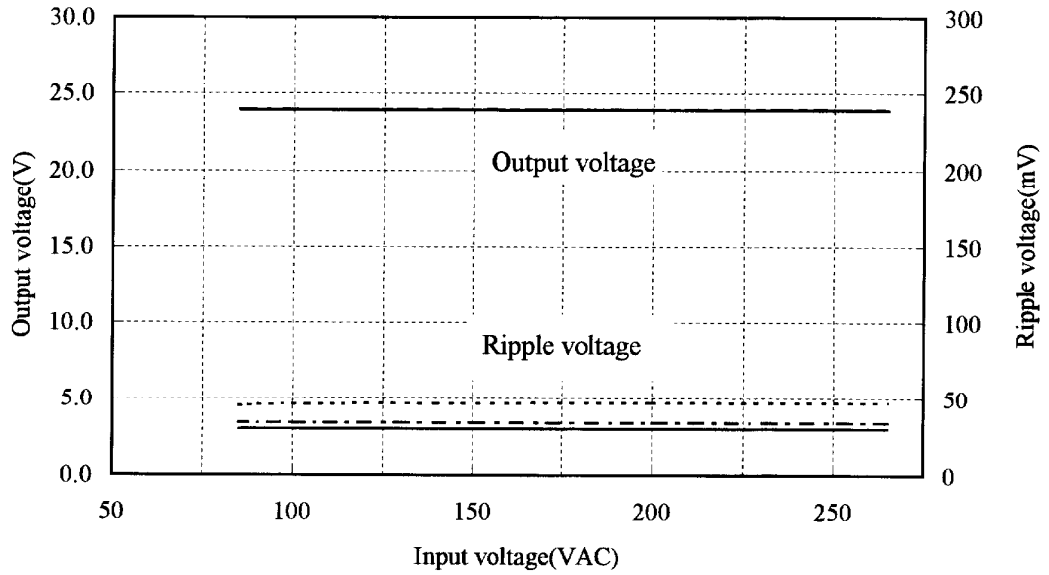

**48V**

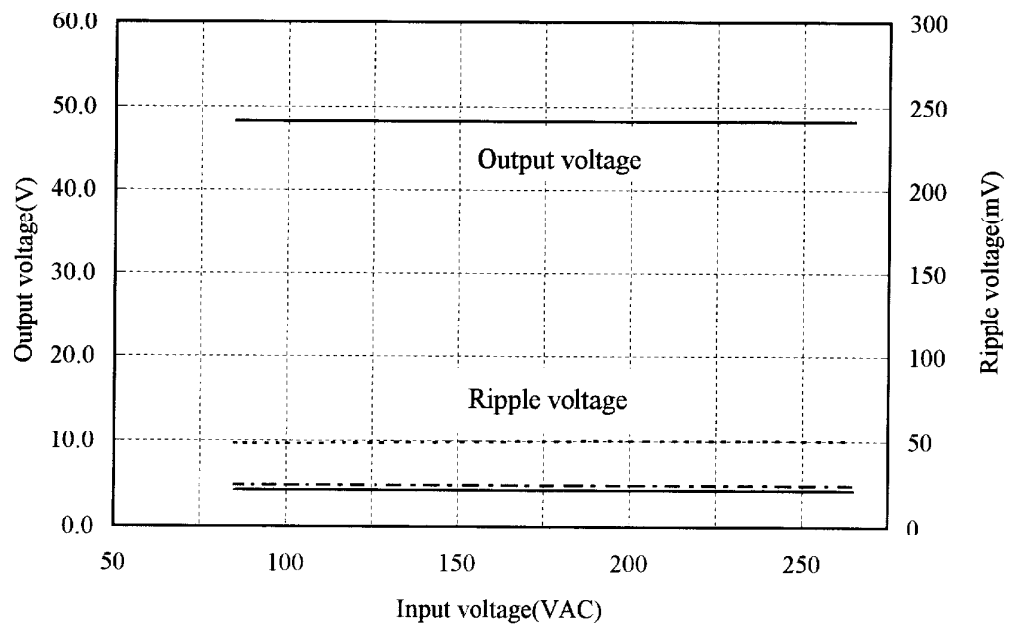

2.1 (3) 効率、入力電流対出力電流

Efficiency and Input current v.s. Output current

Conditions  $V_{in}$  : 85VAC -----  
 : 100VAC - - - - -  
 : 200VAC ————  
 : 265VAC - - - - -  
 $T_a$  : 25°C

**24V**

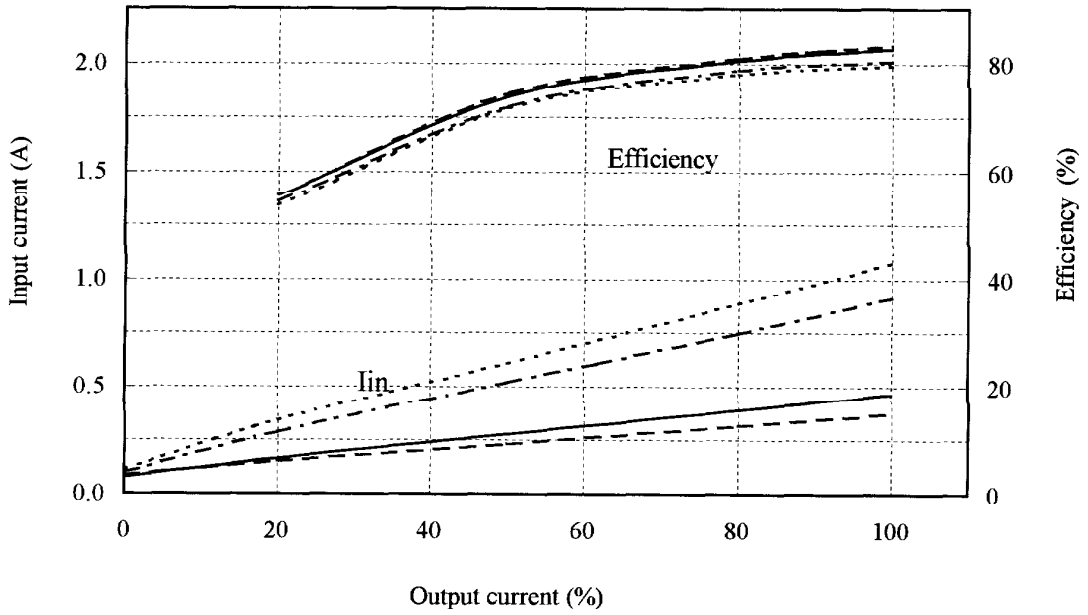

**48V**

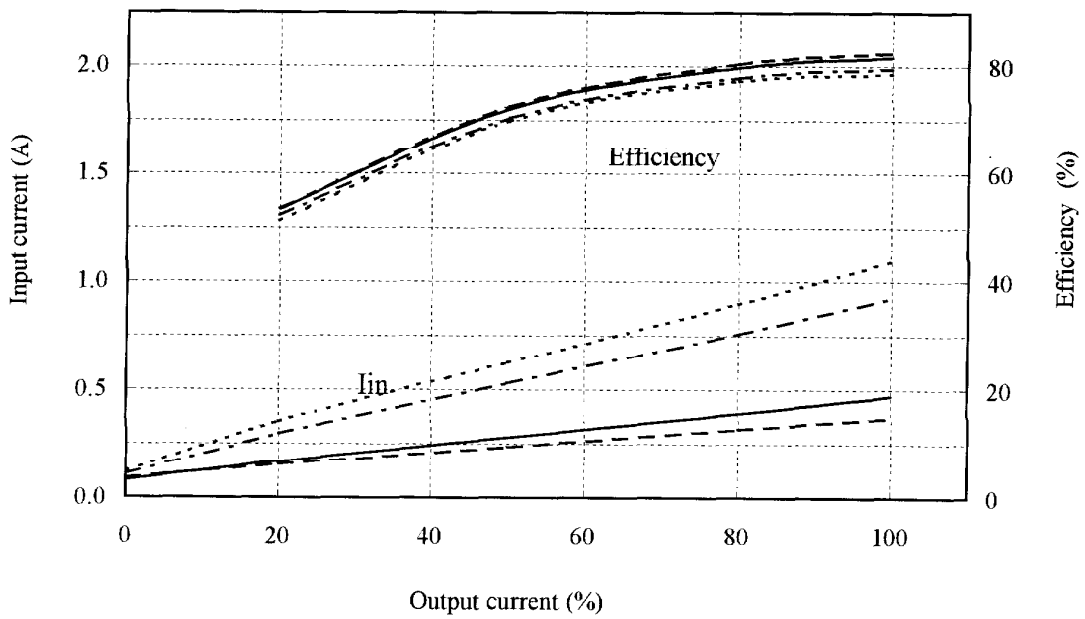

2.1 (4) 力率、入力電流対出力電流

Power factor and Input current v.s. Output current

Conditions Vin : 85VAC -----  
                  : 100VAC - - - - -  
                  : 200VAC ————  
                  : 265VAC - - - - -  
                  Ta : 25°C

24V

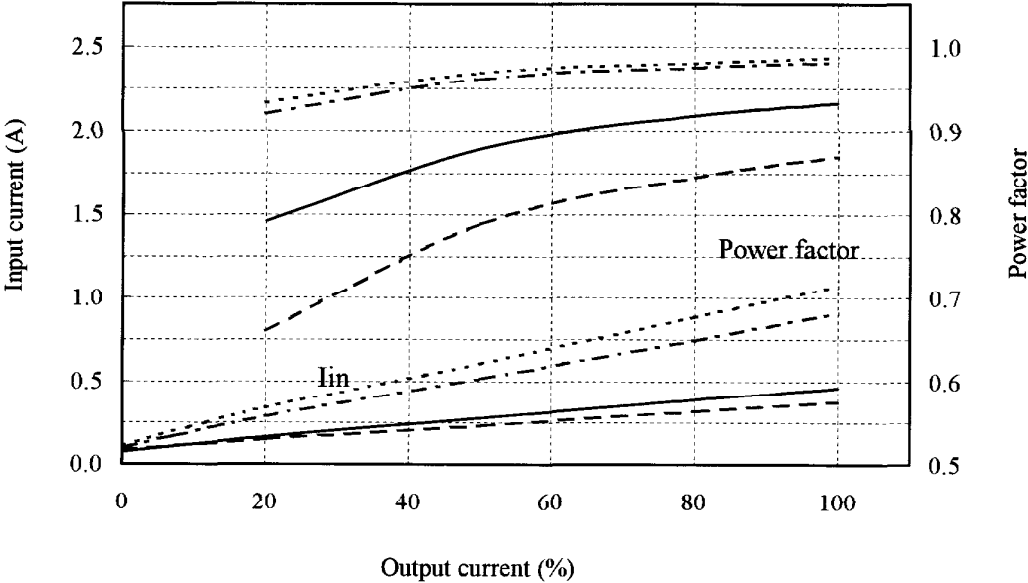

48V

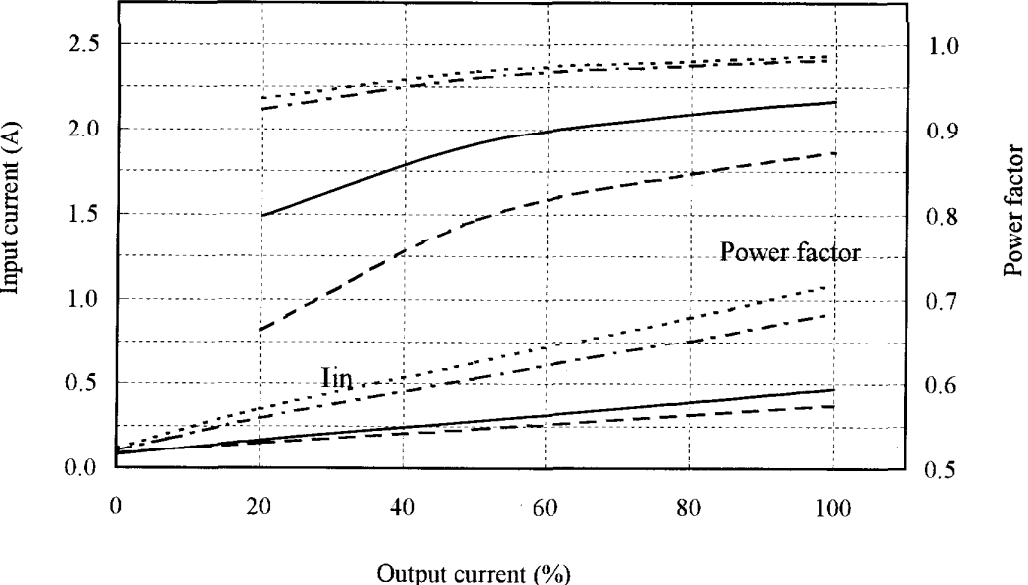

2.2 通電ドリフト特性  
Warm up voltage drift characteristics

Conditions Vin : 100VAC  
Iout : 100%  
Ta : 25°C

24V

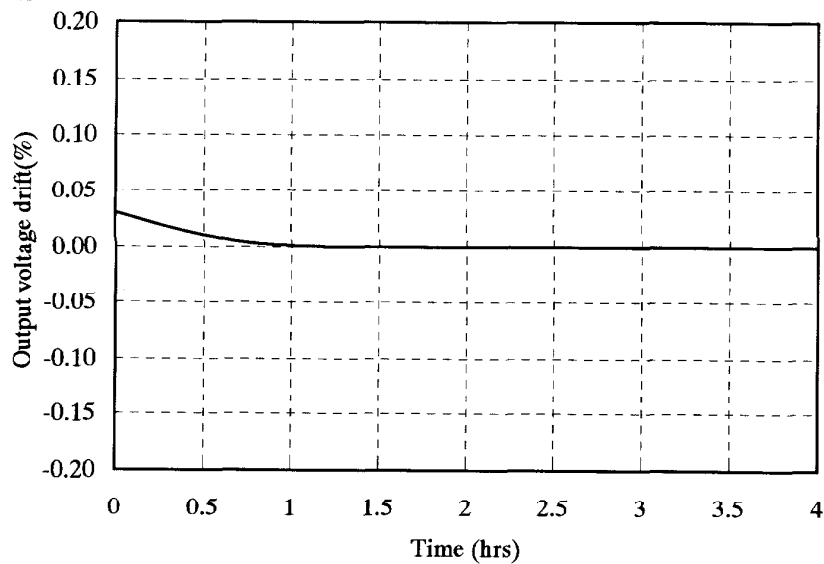

48V

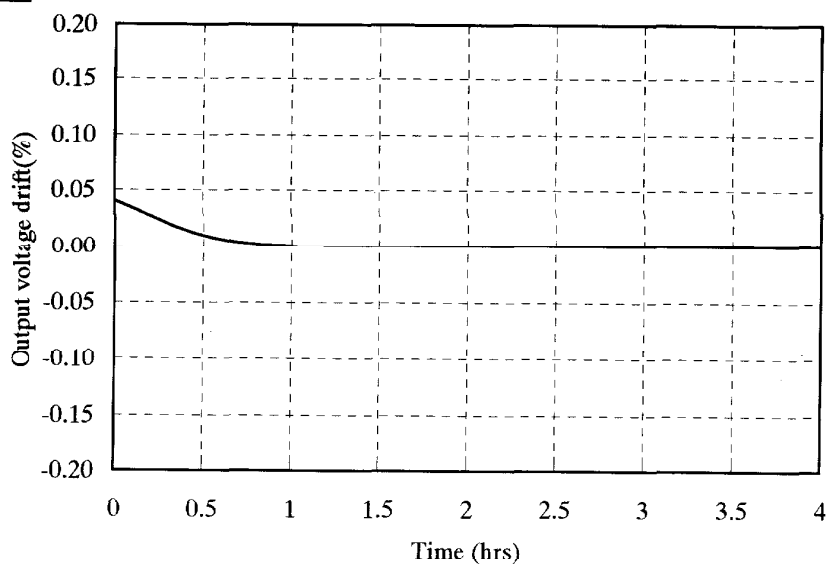

2.3 過電流保護特性

Over current protection (OCP) characteristics

Conditions Ta : -10°C .....  
 : 25°C - - - -  
 : 50°C ————  
 Vin : 85-265VAC

**24V**

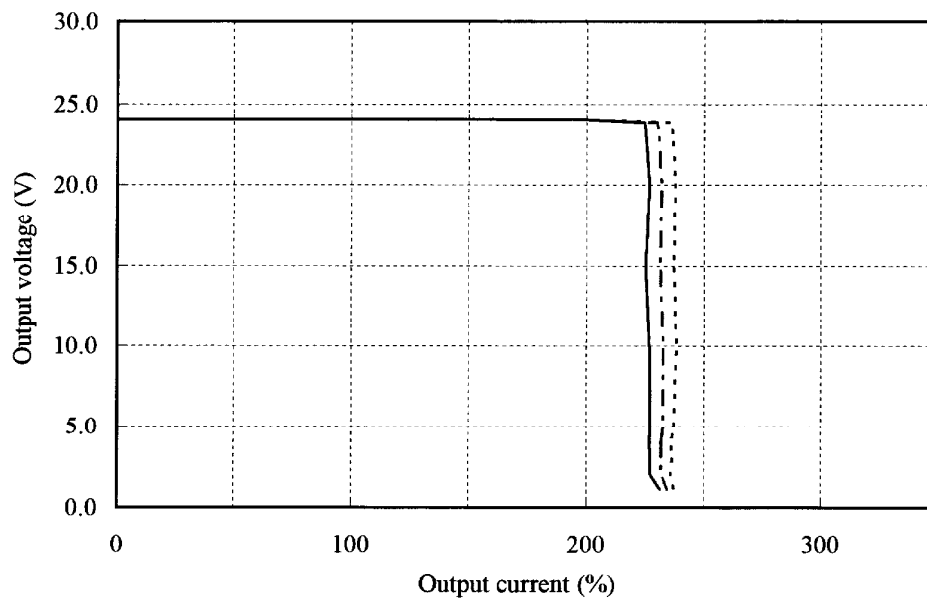

**48V**

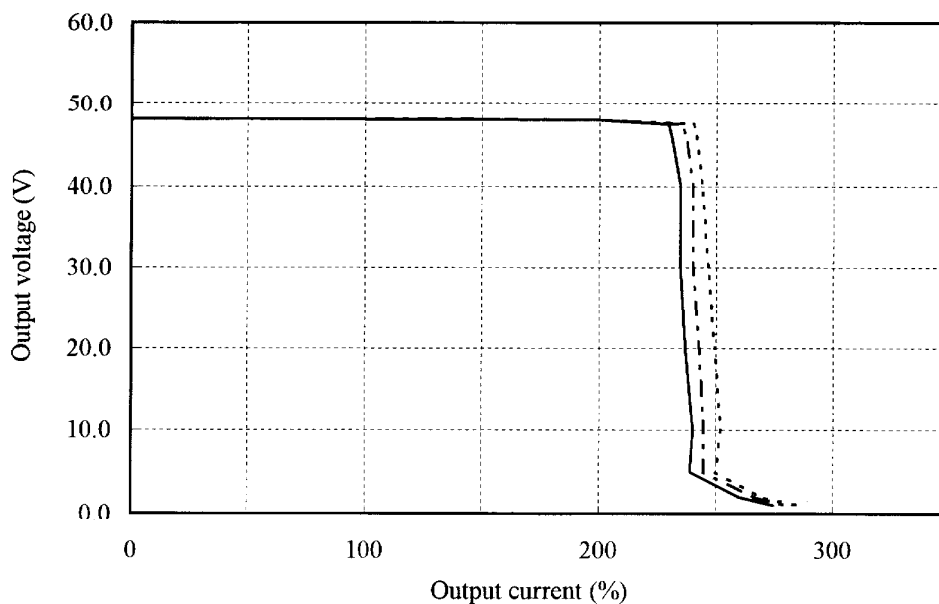

2.4 過電圧保護特性  
Over voltage protection (OVP) characteristics

Conditions Vin : 100VAC  
Iout : 0%  
Ta : 25°C

24V

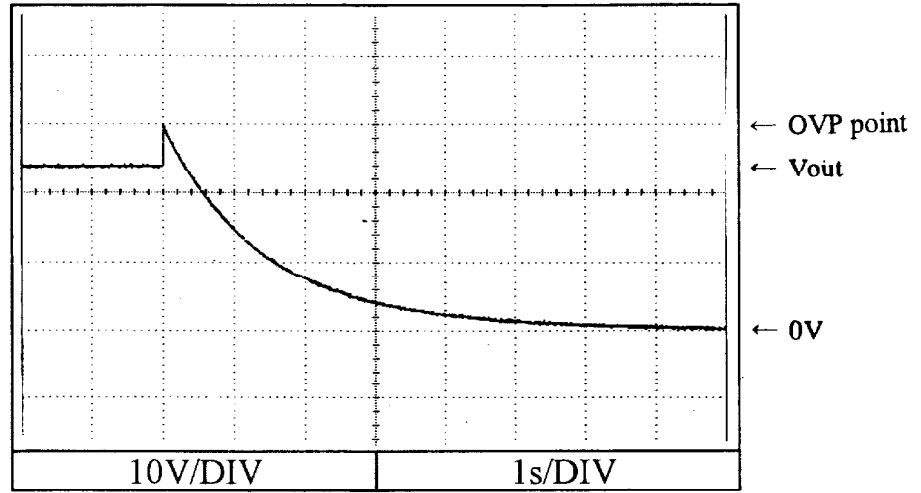

48V

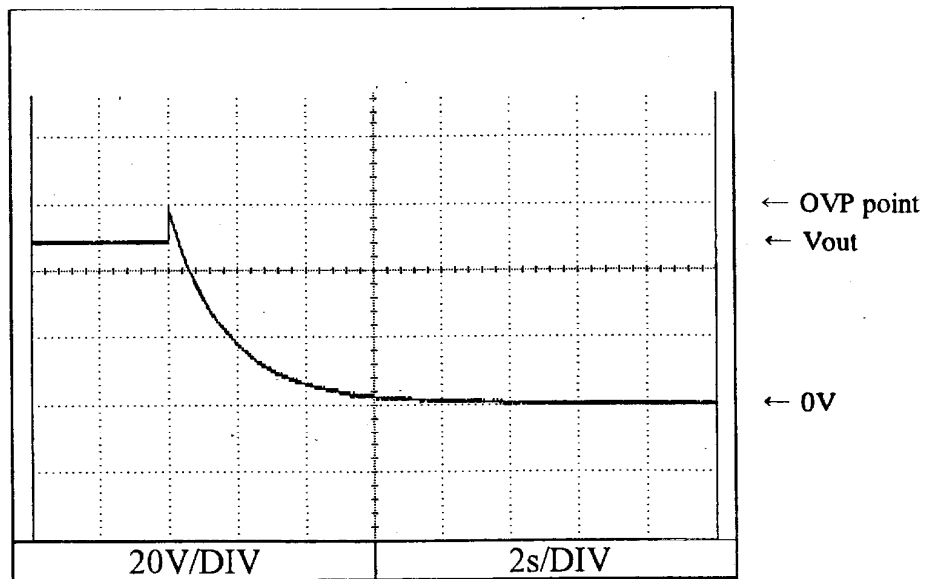



2.5 出力立ち上がり特性  
Output rise characteristics

Conditions Vin : 85VAC (A)  
: 100VAC (B)  
: 200VAC (C)  
: 265VAC (D)  
Iout : 0%  
Ta : 25°C

24V

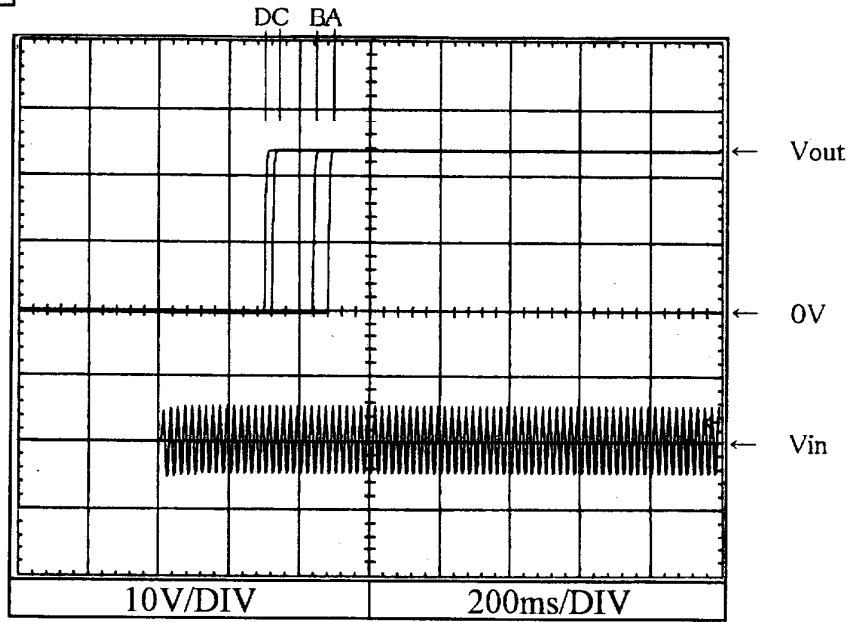

48V

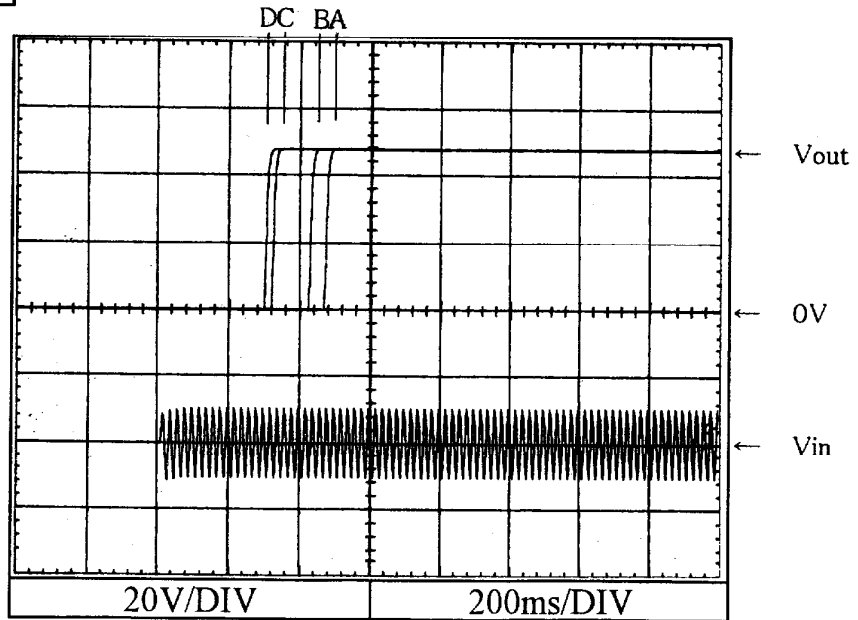

2.5 出力立ち上がり特性  
Output rise characteristics

Conditions Vin : 85VAC (A)  
: 100VAC (B)  
: 200VAC (C)  
: 265VAC (D)  
Iout : 100%  
Ta : 25°C

24V

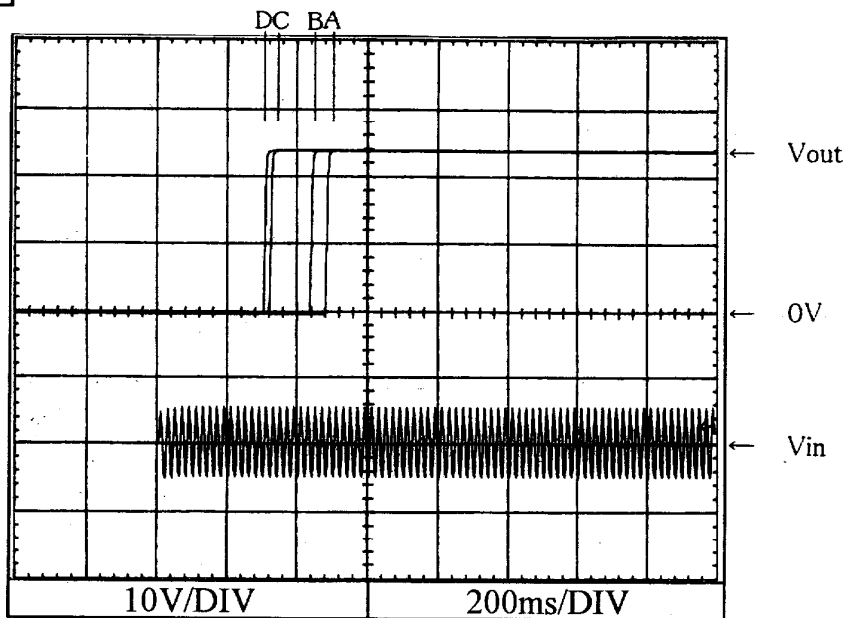

48V

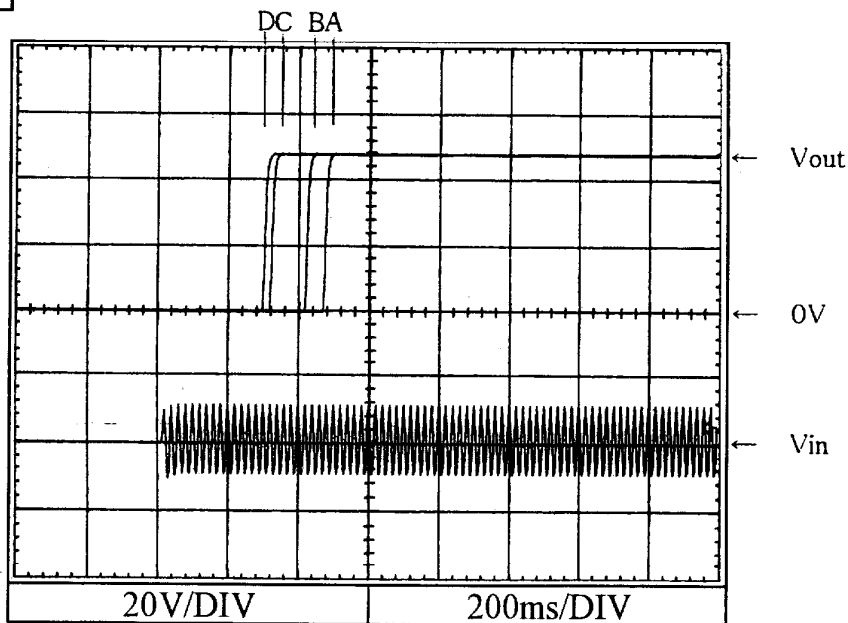

2.6 出力立ち下がり特性  
Output fall characteristics

Conditions Vin : 85VAC (A)  
                  : 100VAC (B)  
                  : 200VAC (C)  
                  : 265VAC (D)  
Iout : 0%  
Ta : 25°C

24V

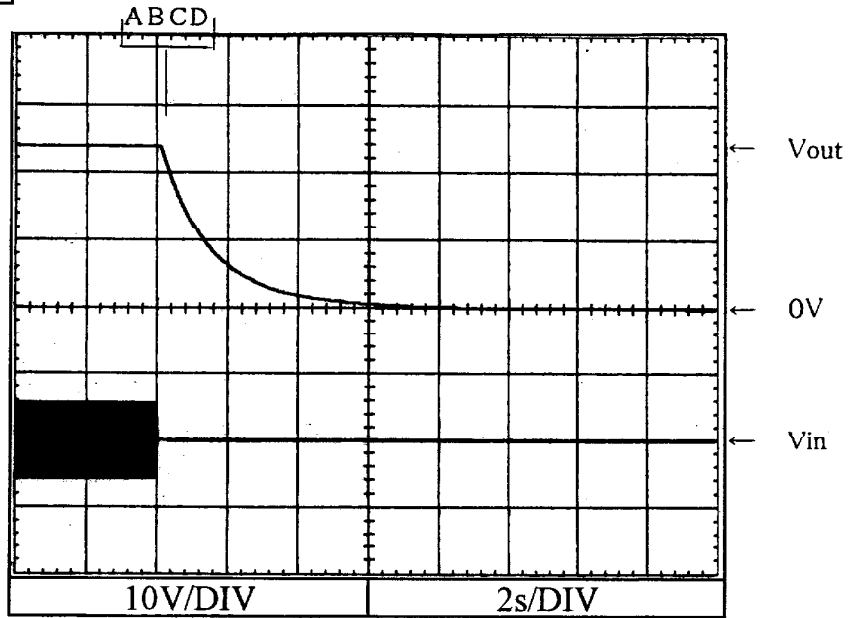

48V

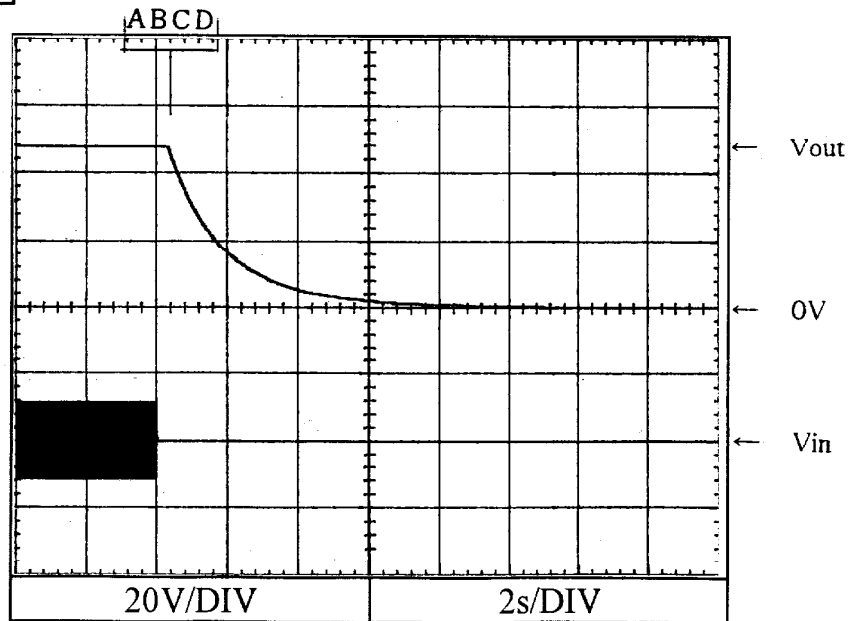

2.6 出力立ち下がり特性  
Output fall characteristics

Conditions Vin : 85VAC (A)  
                  : 100VAC (B)  
                  : 200VAC (C)  
                  : 265VAC (D)  
Iout : 100%  
Ta : 25°C

24V

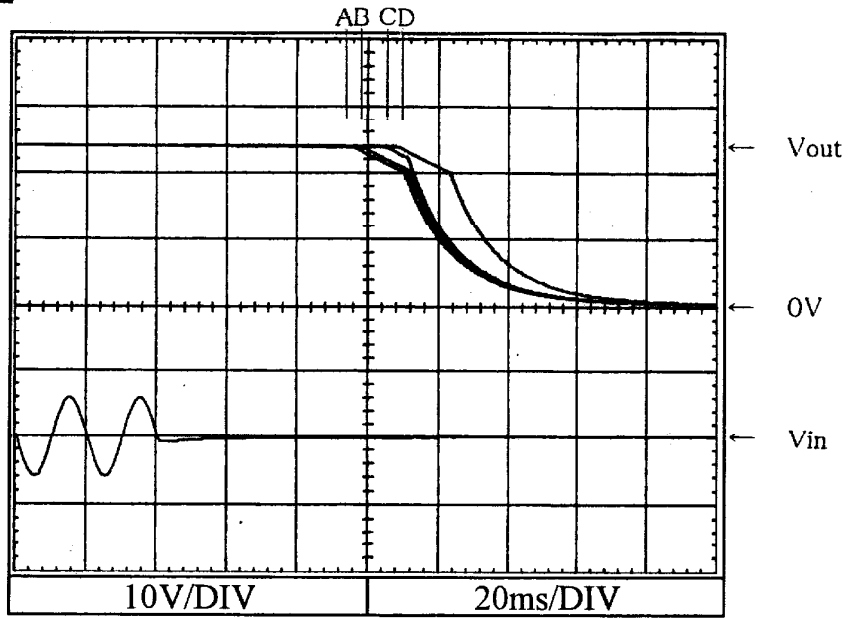

48V

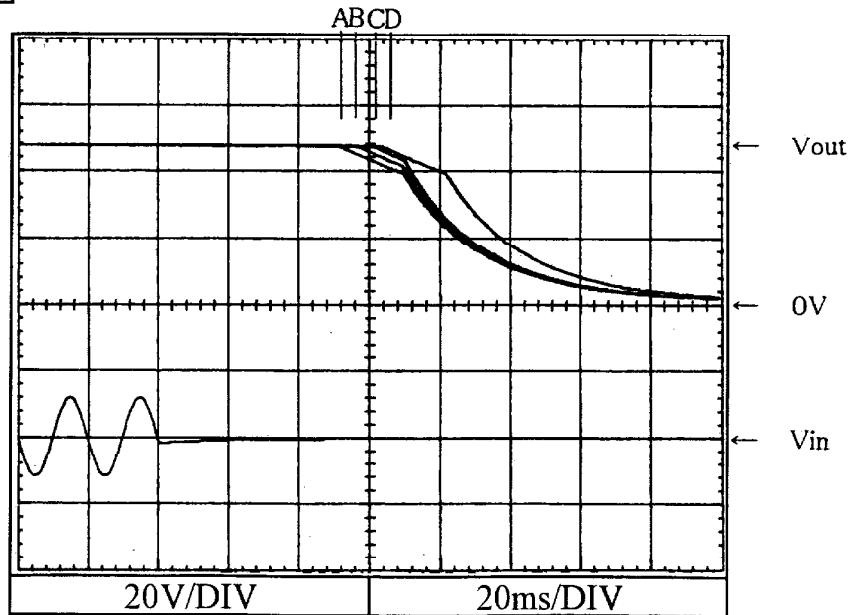

2.7 出力保持時間特性  
Hold up time characteristics

Conditions Vin : 100VAC .....  
                  : 200VAC       —  
                  Ta : 25°C

24V

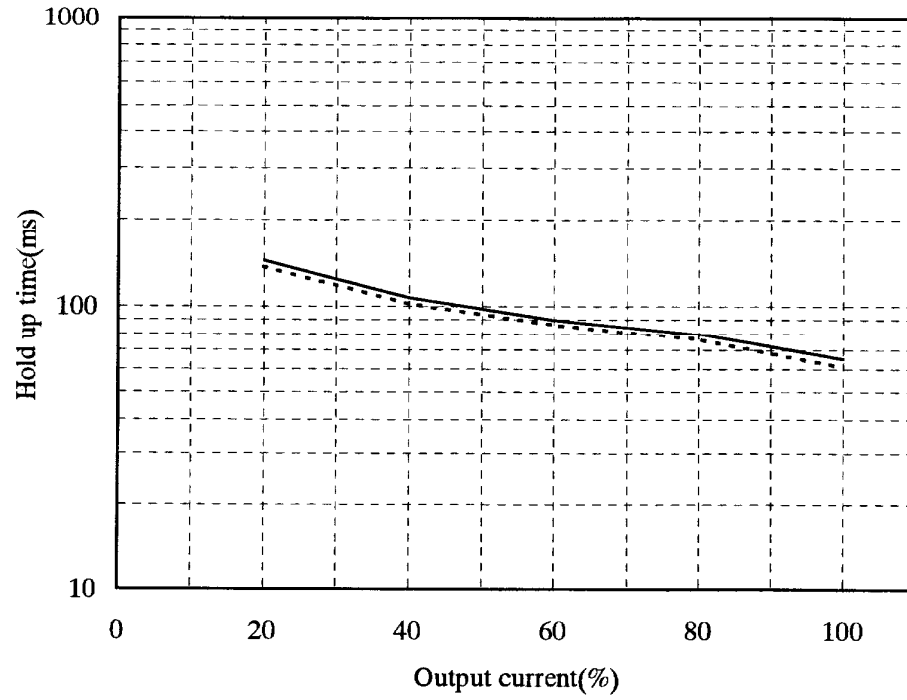

48V

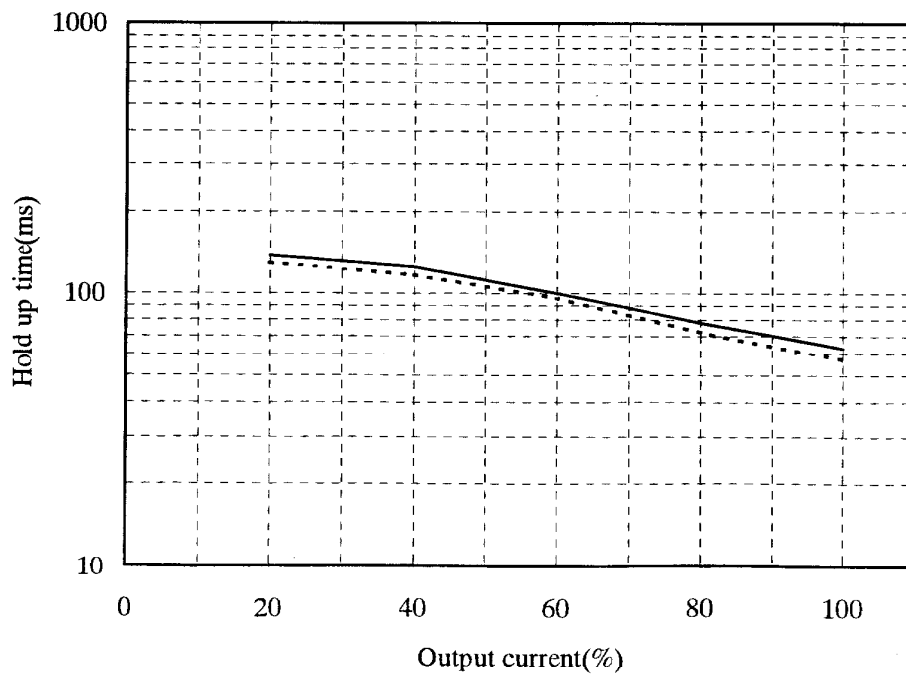

2.8 過渡応答 (入力急変) 特性  
 Dynamic line response characteristics

Conditions Vin : 85VAC $\longleftrightarrow$ 132VAC(A)  
 170VAC $\longleftrightarrow$ 265VAC(B)  
 Iout : 100%  
 Ta : 25°C

24V

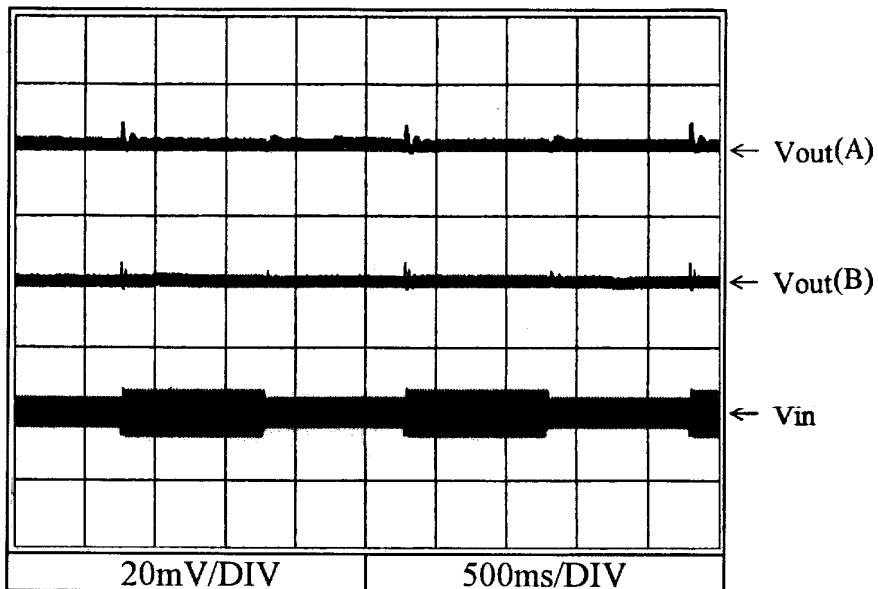

48V

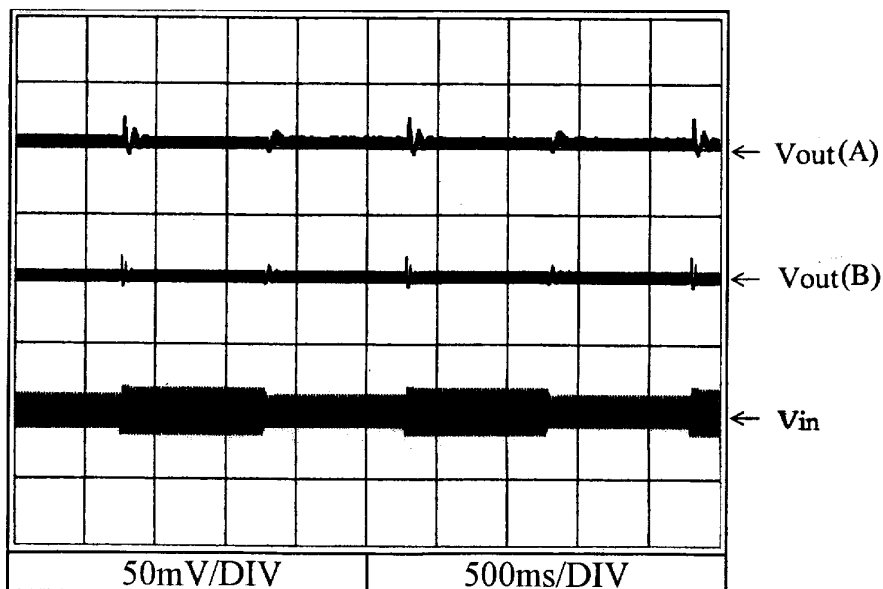

2.9 過渡応答 (負荷急変) 特性  
Dynamic load response characteristics

Conditions Vin : 100VAC  
Ta : 25°C

24V

f=100Hz

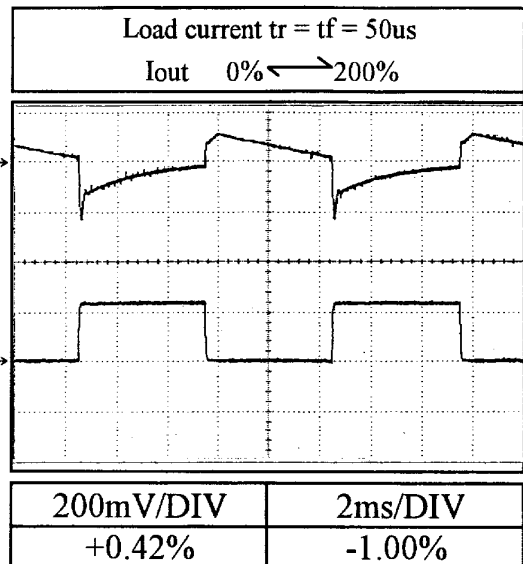
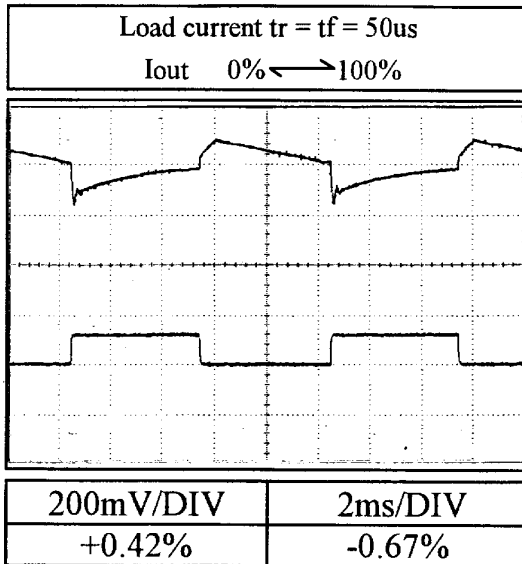

f=1kHz

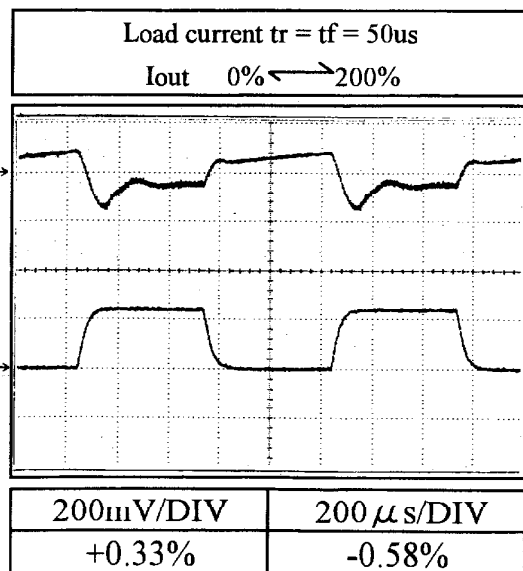
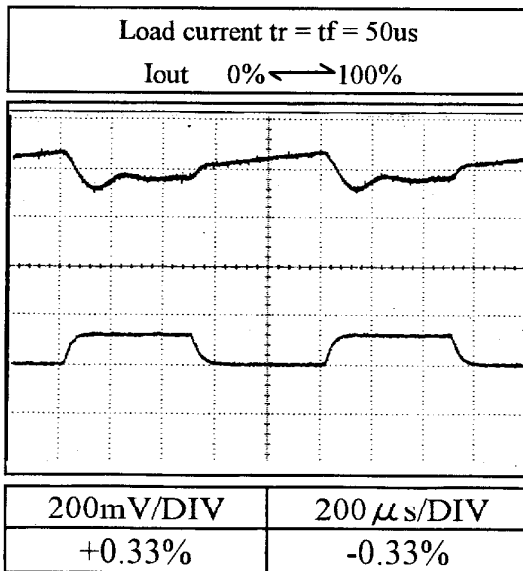

2.9 過渡応答 (負荷急変) 特性  
Dynamic load response characteristics

Conditions Vin : 100VAC  
Ta : 25°C

48V

f=100Hz

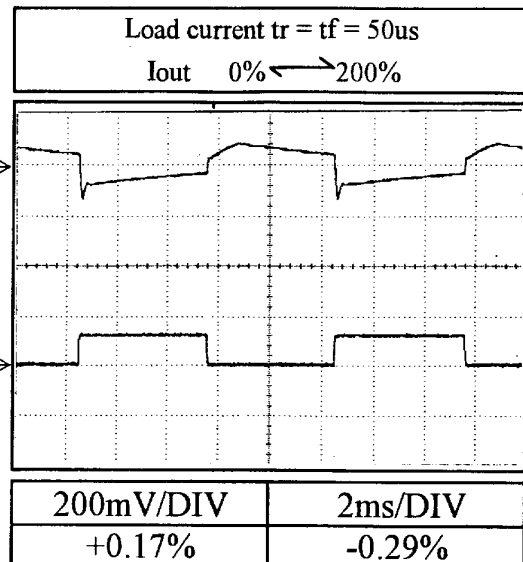
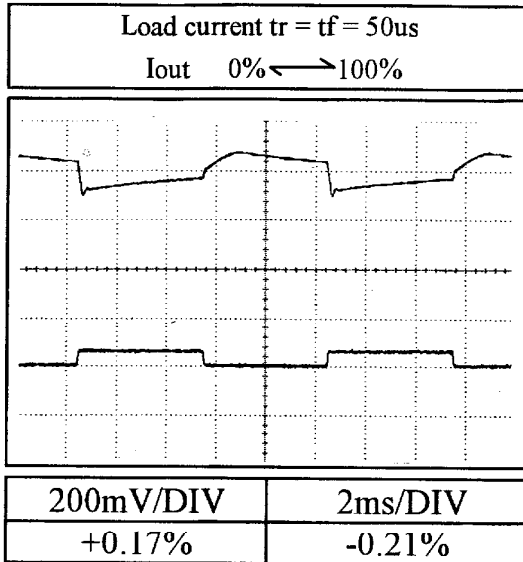

f=1kHz

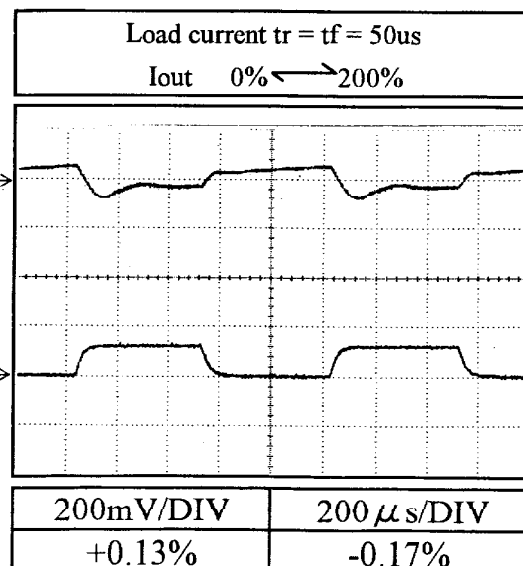
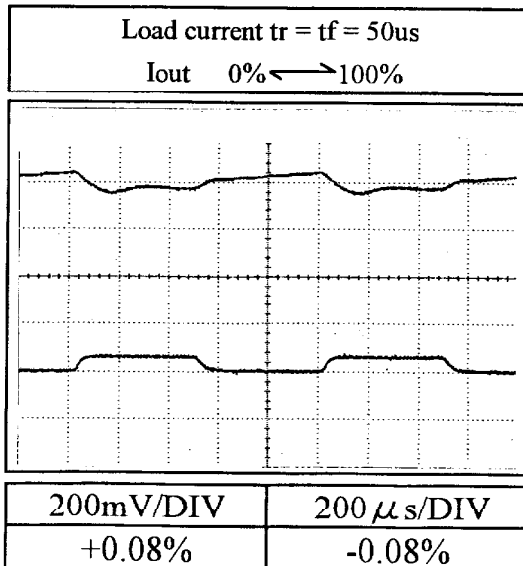



2.10 入力電圧瞬停特性  
Response to brown out characteristics

Conditions Vin : 100VAC  
Iout : 100%  
Ta : 25°C

**24V**

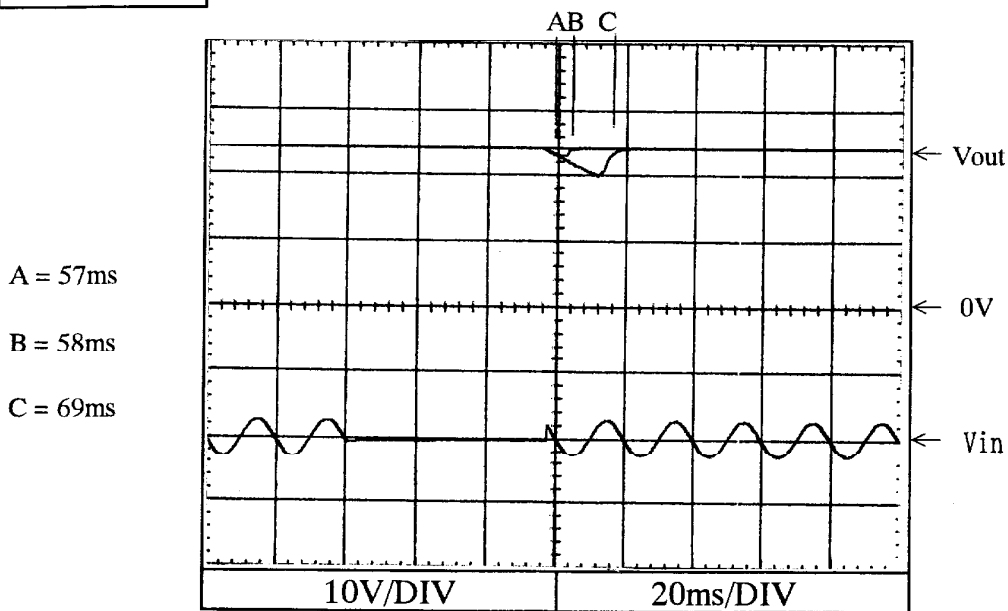

**48V**

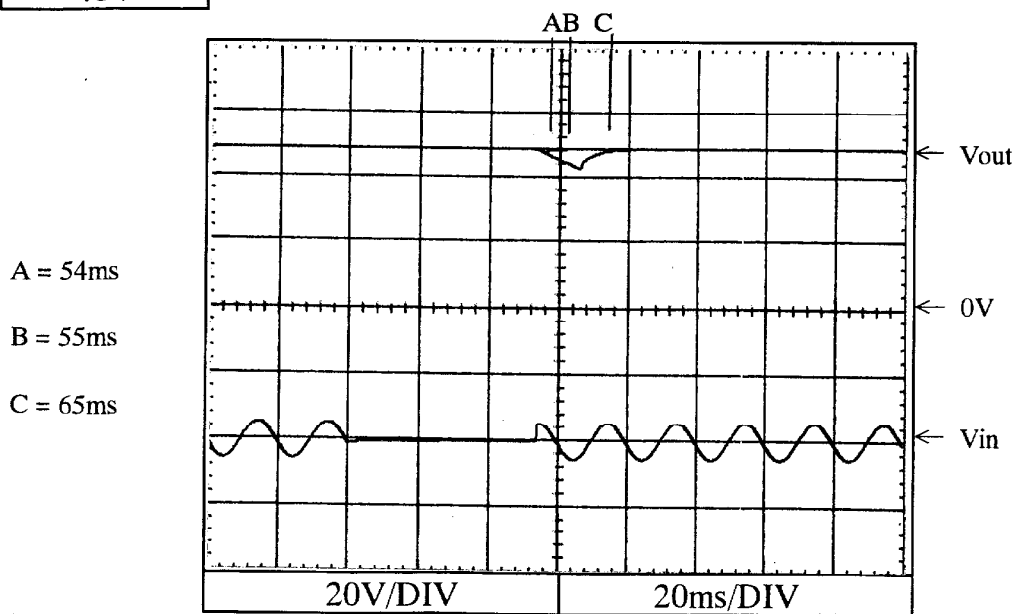

2.10 入力電圧瞬停特性  
Response to brown out characteristics

Conditions Vin : 200VAC  
Iout : 100%  
Ta : 25°C

**24V**

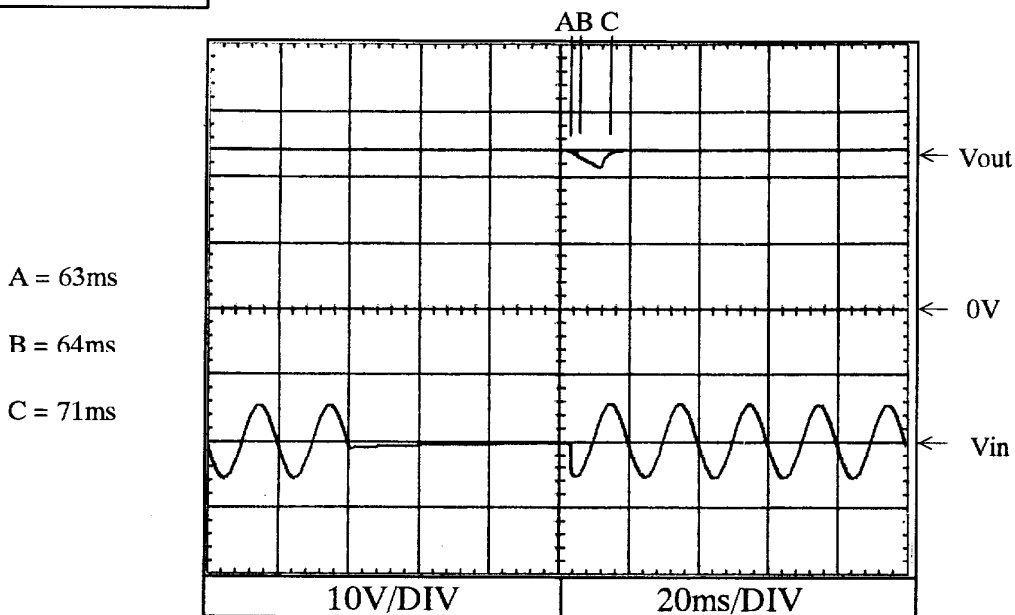

**48V**

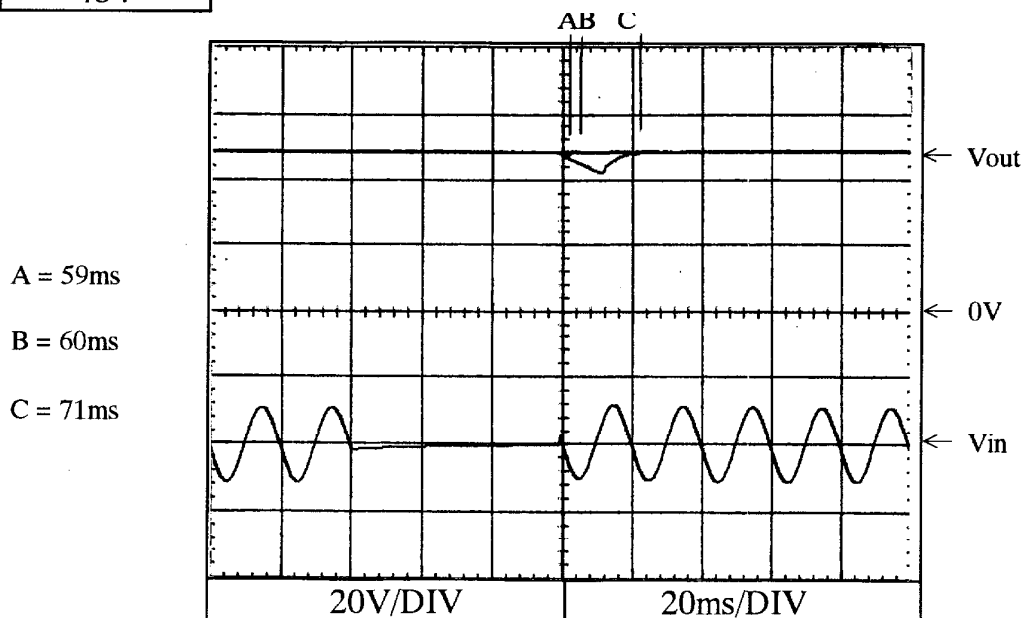

2.11 入力サージ電流 (突入電流) 特性  
Inrush current waveform

Conditions Vin : 100VAC  
Iout : 100%  
Ta : 25°C

24V

Switch on phase angle  
of input AC voltage  
 $\phi = 0^\circ$

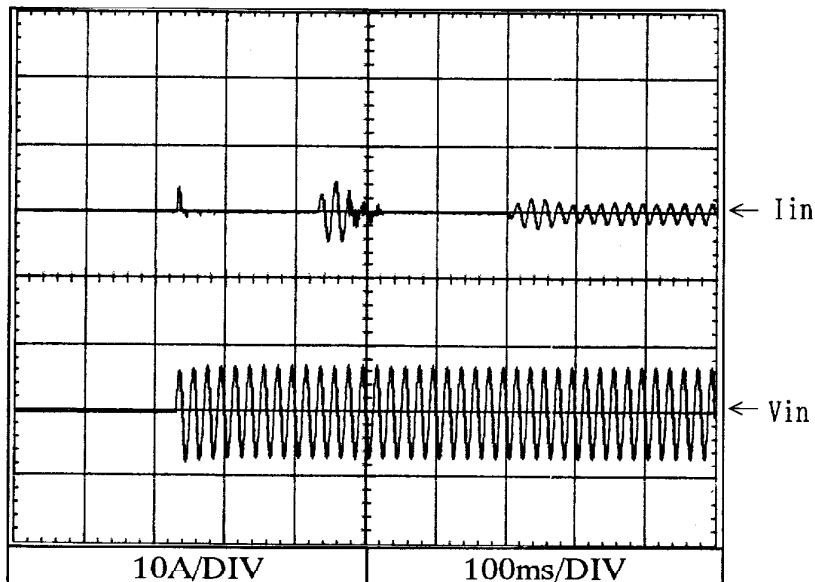

Switch on phase angle  
of input AC voltage  
 $\phi = 90^\circ$

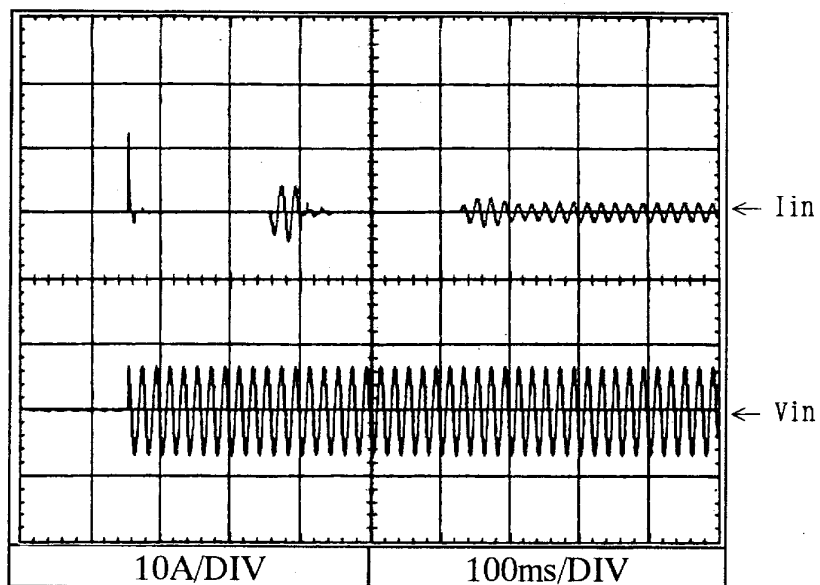

2.11 入力サージ電流 (突入電流) 特性  
Inrush current waveform

Conditions Vin : 200VAC  
Iout : 100%  
Ta : 25°C

24V

Switch on phase angle  
of input AC voltage  
 $\phi = 0^\circ$

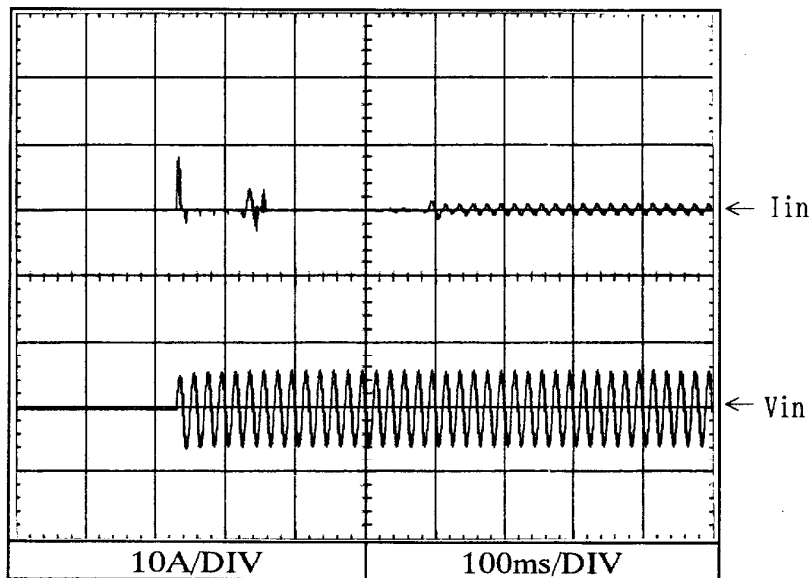

Switch on phase angle  
of input AC voltage  
 $\phi = 90^\circ$

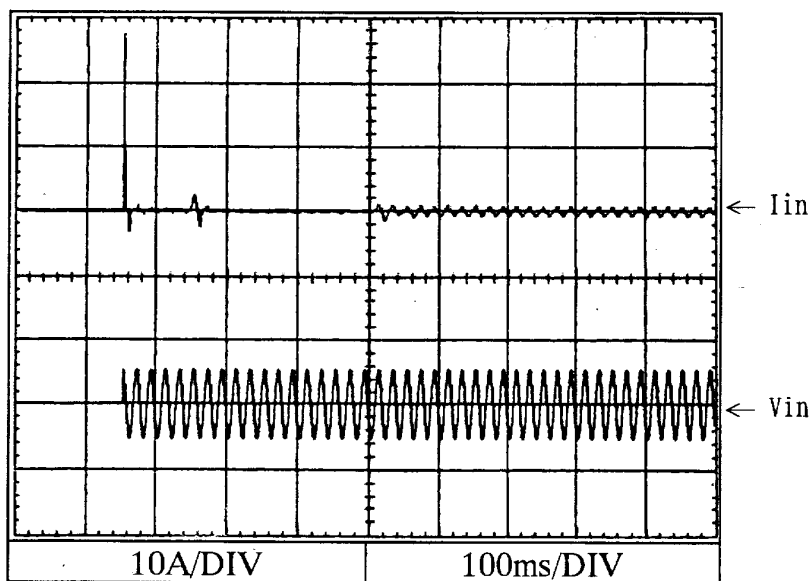

2.12 瞬停時突入電流特性  
Inrush current characteristics

Conditions Iout : 0% -----  
: 50% - - - - -  
: 100% ————  
Ta : 25°C

24V

Vin : 100VAC

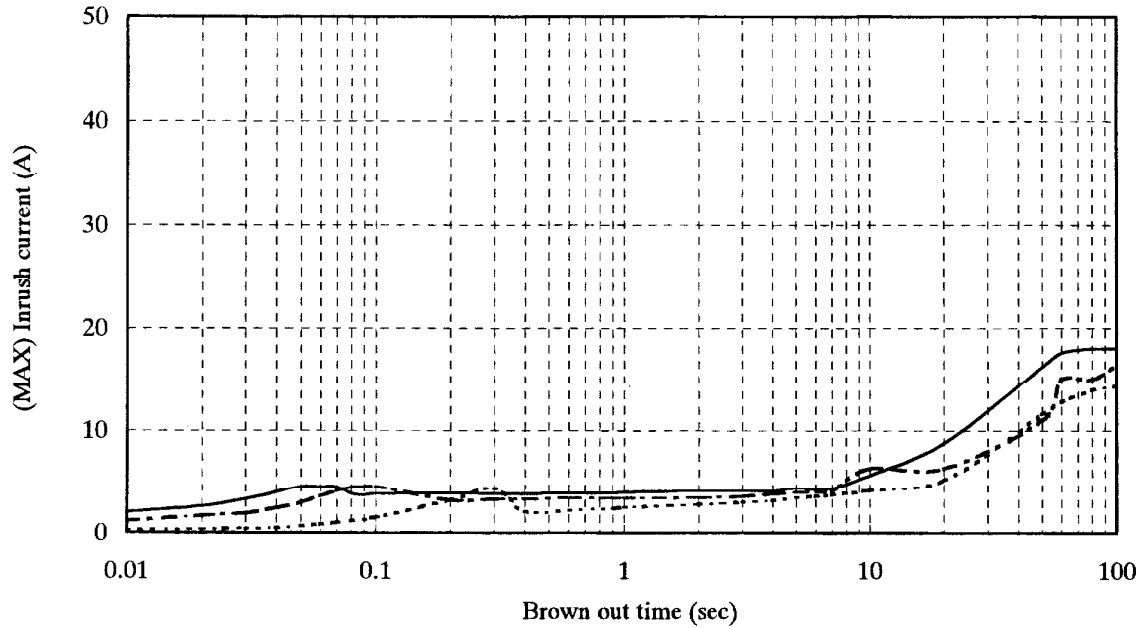

Vin : 200VAC

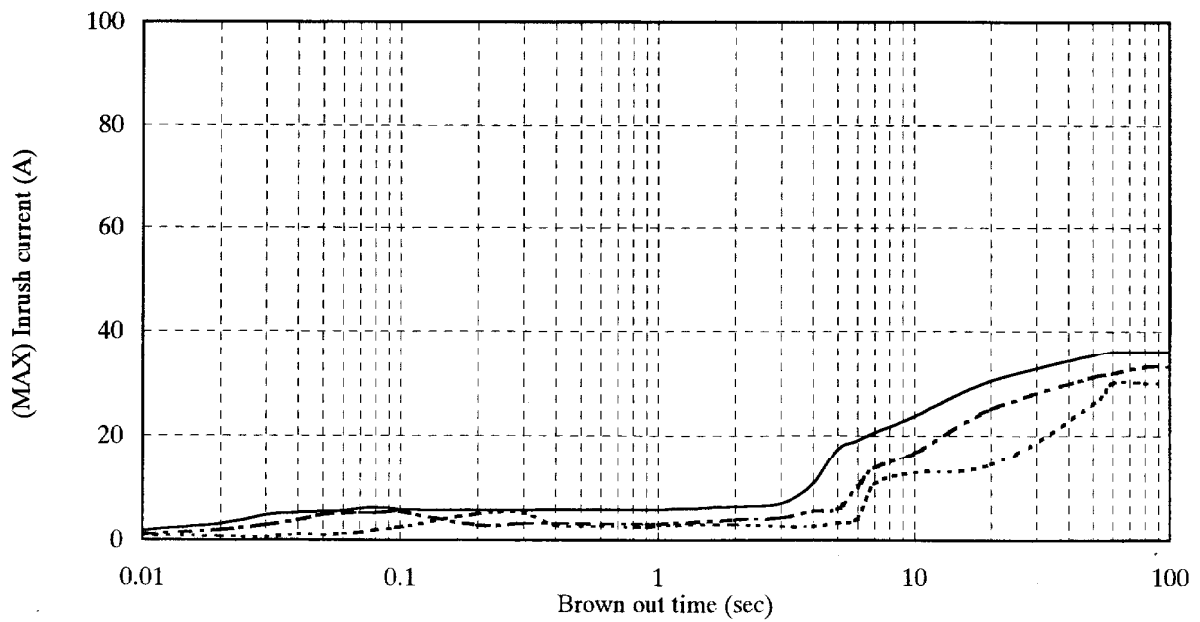

2.13 入力電流波形  
Input current waveform

24V

Conditions Vin : 100VAC  
Iout : 100%  
Ta : 25°C

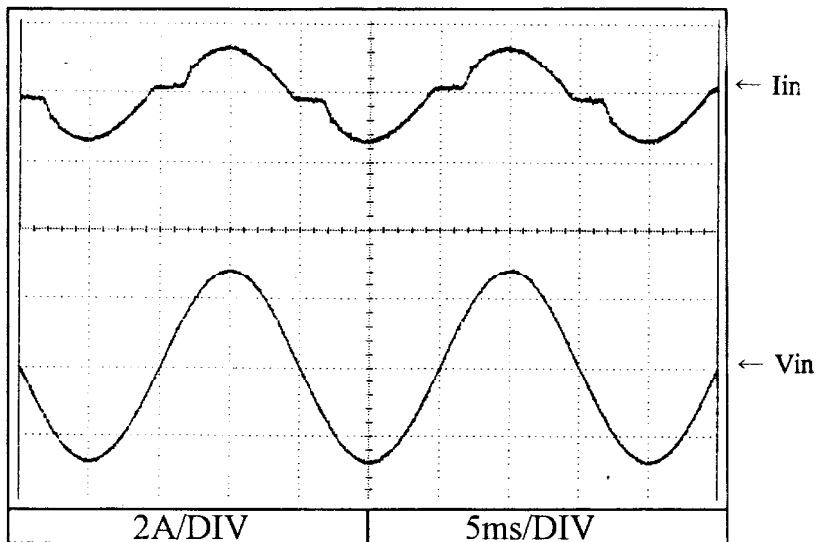

Conditions Vin : 200VAC  
Iout : 100%  
Ta : 25°C

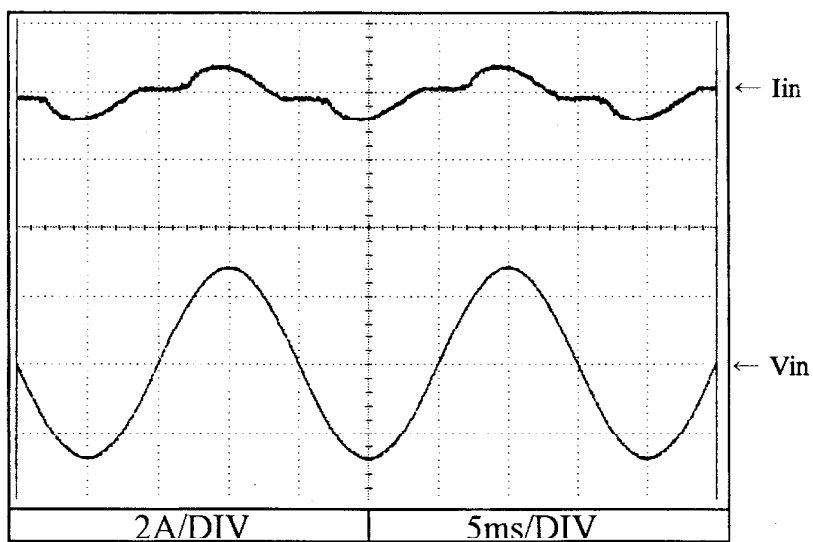

2.14 高調波成分  
Input current harmonics

24V

Conditions Vin : 100VAC  
Iout : 100%  
Ta : 25°C

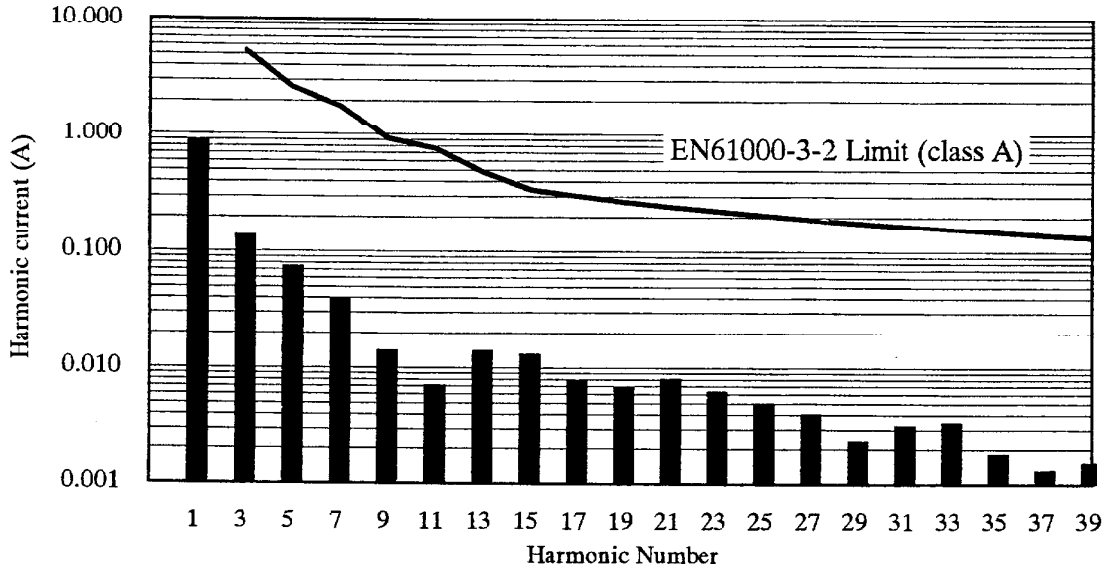

Conditions Vin : 230VAC  
Iout : 100%  
Ta : 25°C

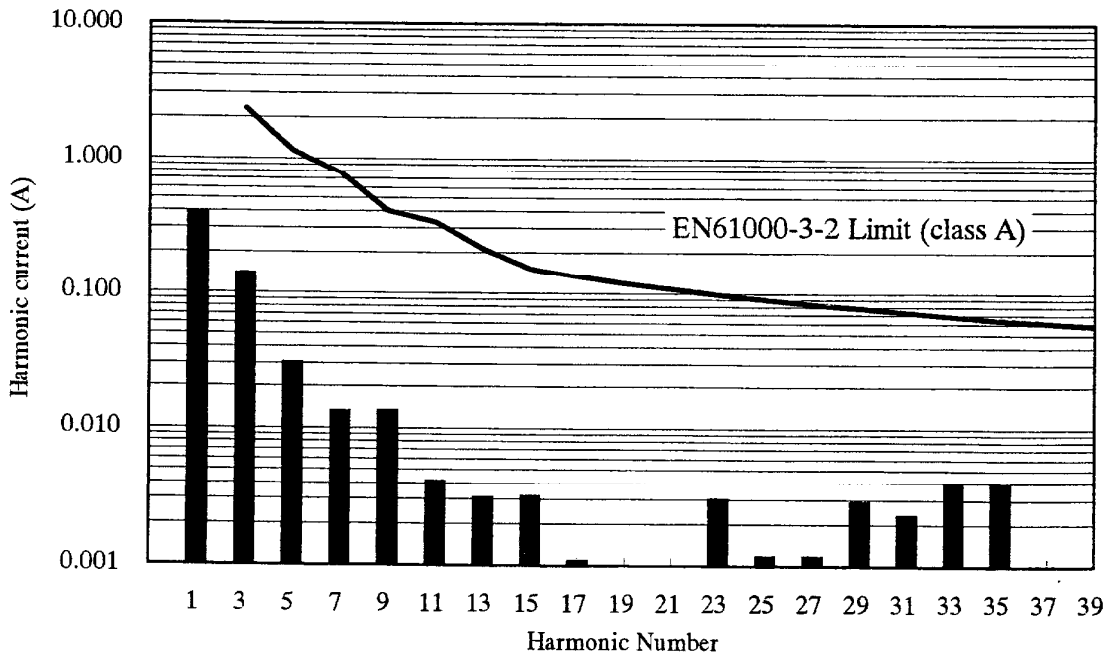

2.15 リーク電流特性

Leakage current characteristics

Conditions Iout : 0% -----  
              : 100% —————  
              Ta : 25°C  
              f : 50Hz

Equipment used : MODEL 229-2 (Simpson)

24V

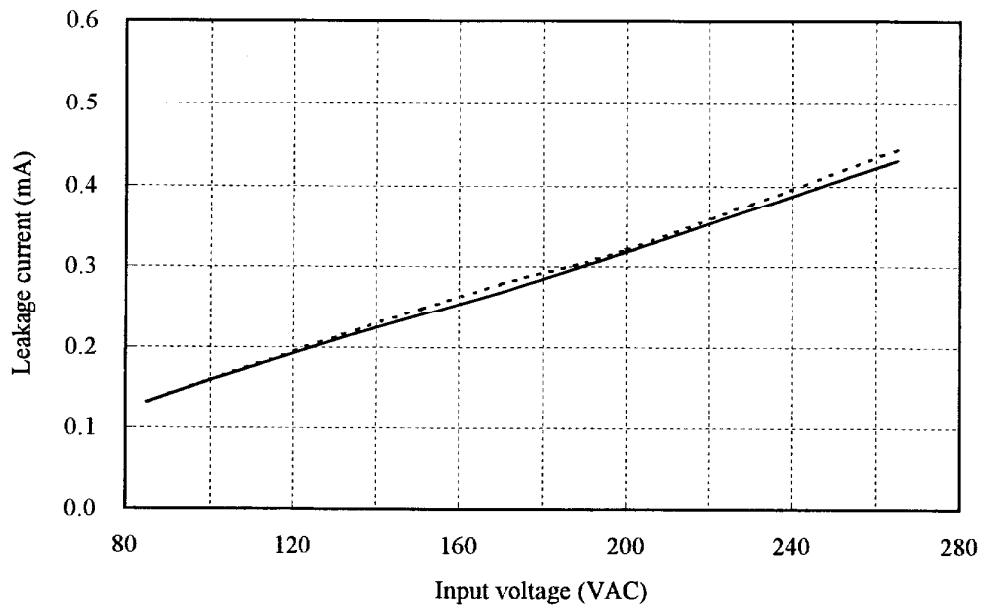

48V

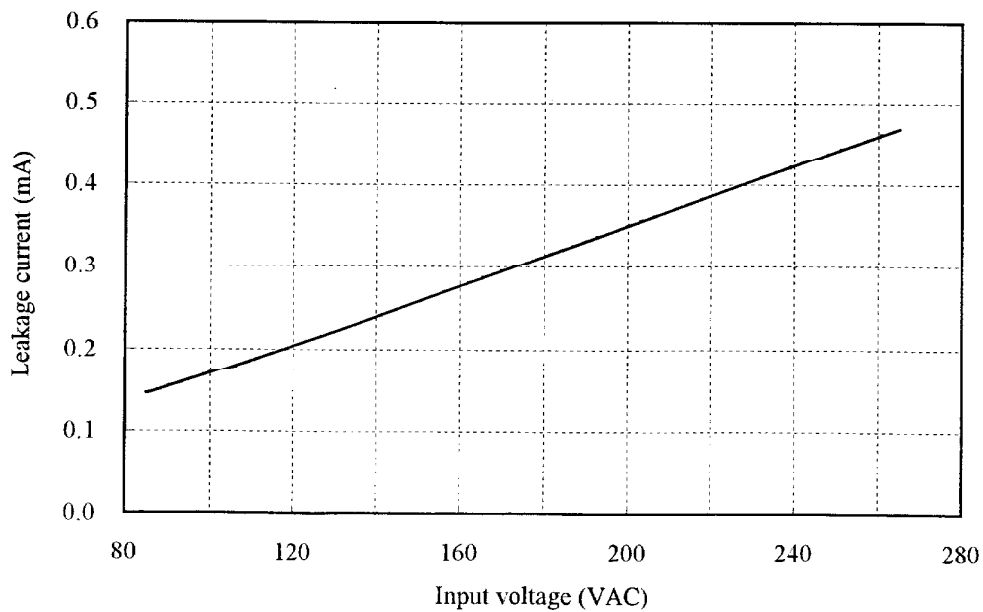



2.15 リーク電流特性

Leakage current characteristics

Conditions Iout : 0% -----  
 : 100% ————  
 Ta : 25°C  
 f : 50Hz

Equipment used : TYPE3226 (YOKOGAWA)

24V

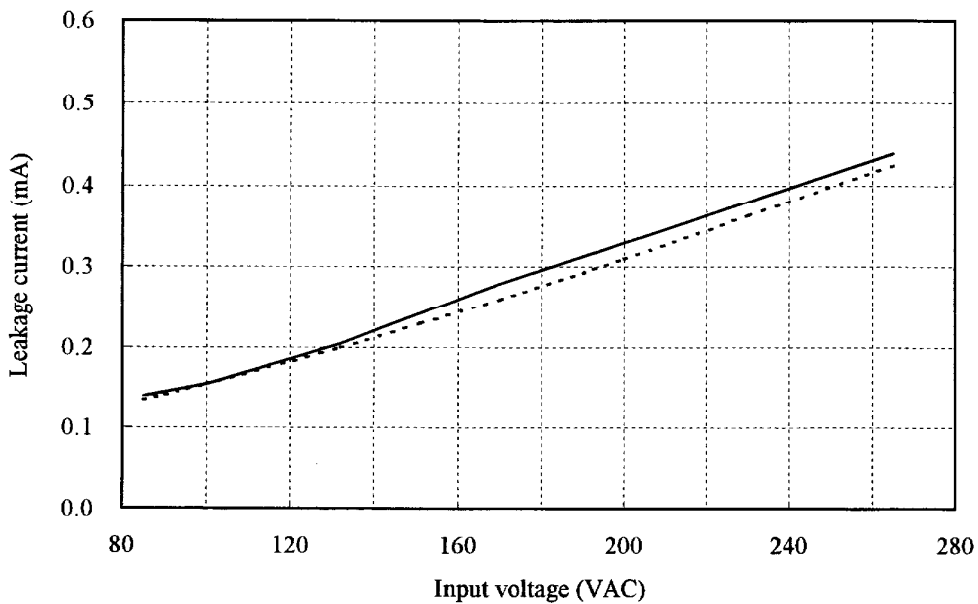

48V

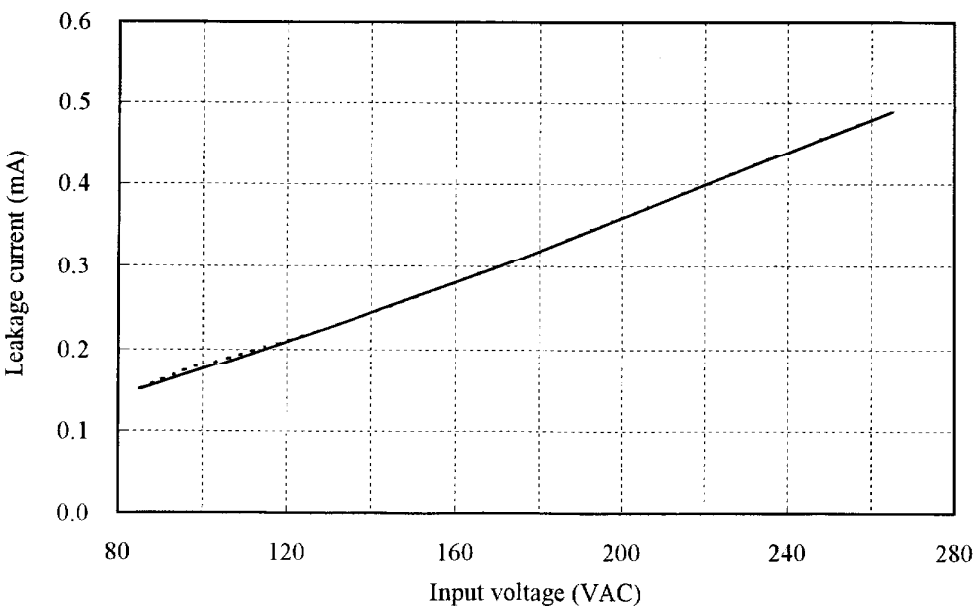

2.16 出力リップル、ノイズ波形  
Output ripple and noise waveform

Conditions Vin : 100VAC  
Iout : 100%  
Ta : 25°C

NORMAL MODE

24V

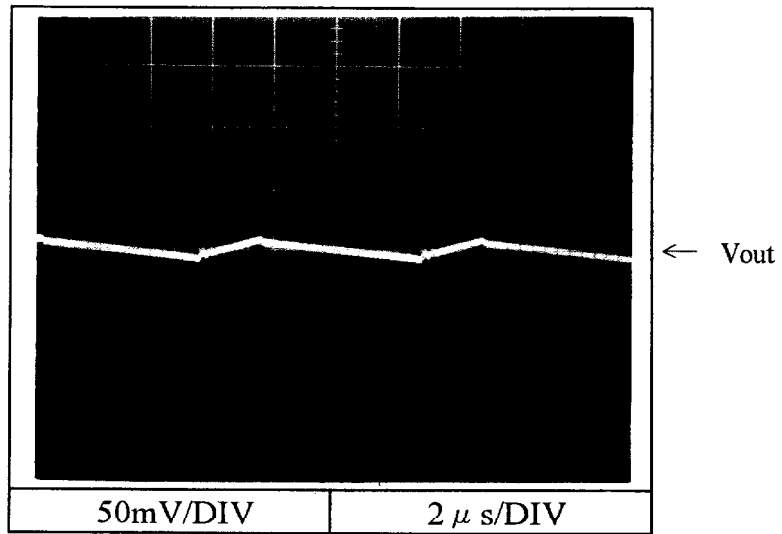

48V

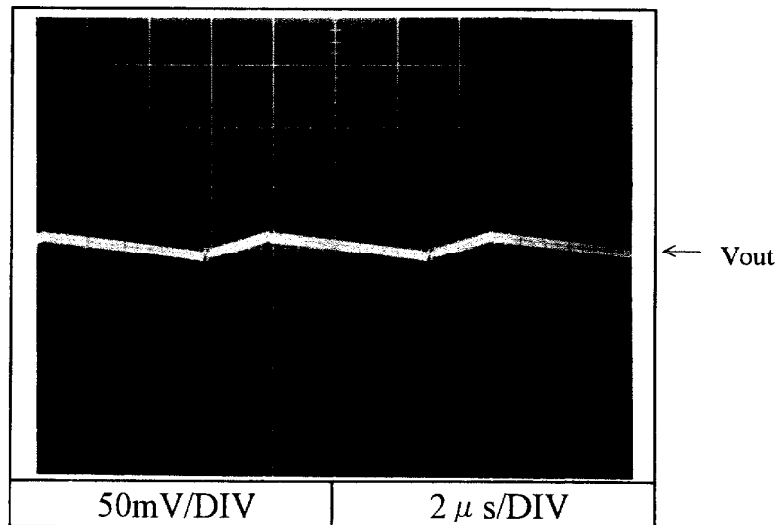

2.16 出力リップル、ノイズ波形  
Output ripple and noise waveform

Conditions Vin : 100VAC  
Iout : 100%  
Ta : 25°C

NORMAL + COMMON MODE

24V

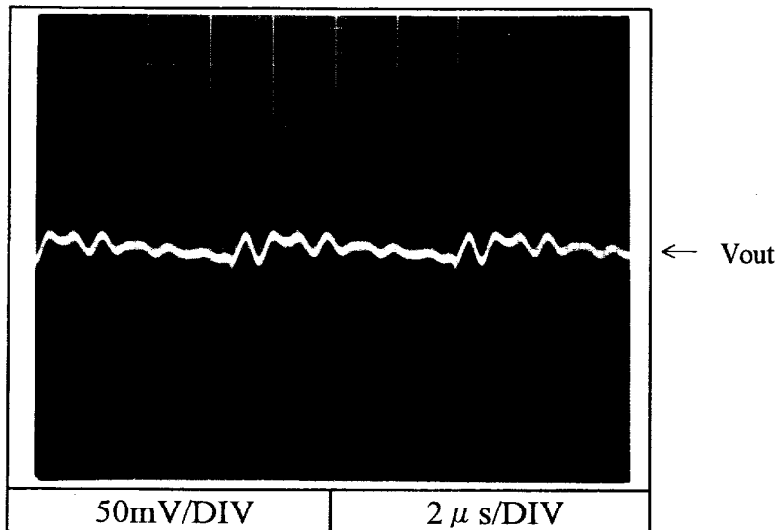

48V

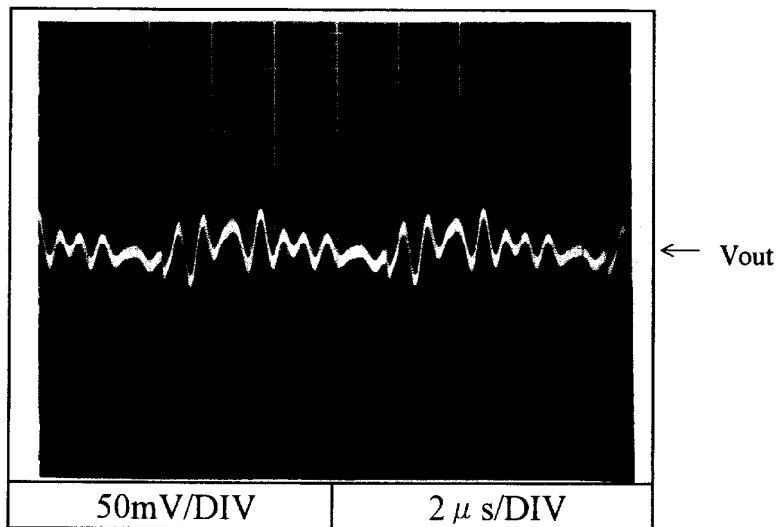

2.17 EMI特性

Electro-Magnetic Interference characteristics

雑音端子電圧  
Conducted Emission

24V

Conditions Vin : 100VAC  
Iout : 100%

Point A (184kHz)		
Ref.	VCCI-Limit (dBuV)	Measure (dBuV)
QP	79.0	55.2
AV	66.0	51.7

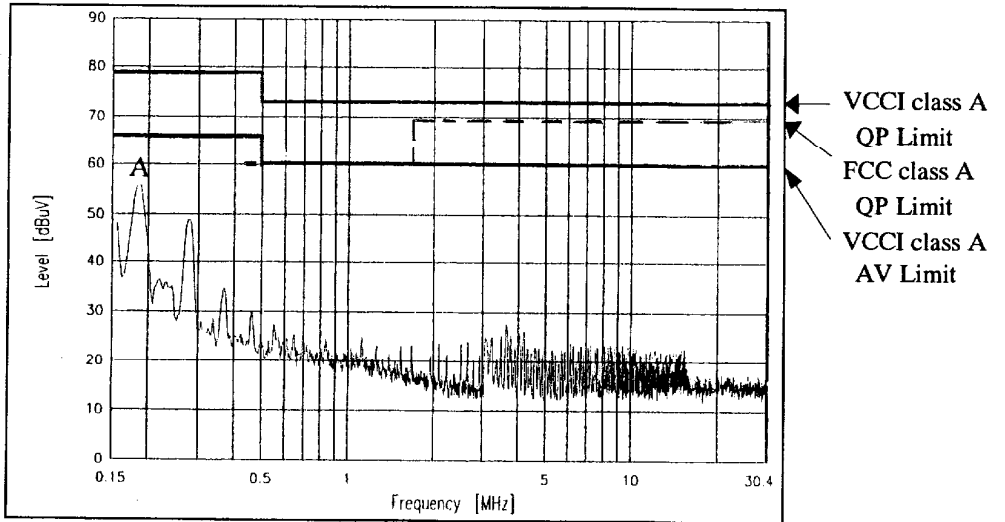

Phase : L

48V

Conditions Vin : 100VAC  
Iout : 100%

Point B (186kHz)		
Ref.	VCCI-Limit (dBuV)	Measure (dBuV)
QP	79.0	54.2
AV	66.0	50.7

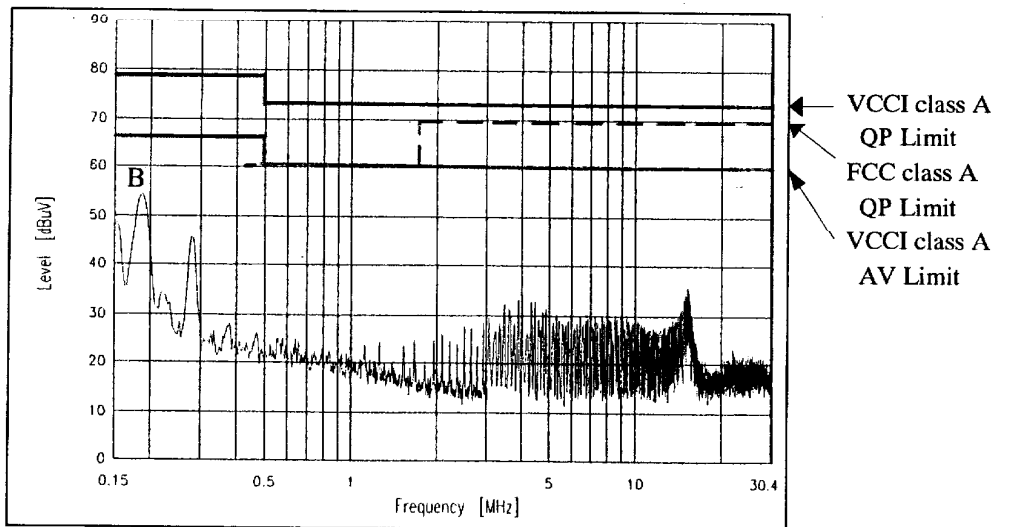

Phase : N

EN55011-A,EN55022-Aの限界値はVCCI class Aの限界値と同じ  
Limits of EN55011-A,EN55022-A are same as its VCCI class A.

2.17 EMI 特性

Electro-Magnetic Interference characteristics

雑音電界強度  
Radiated Emission

Conditions Vin : 100VAC  
Iout : 100%

24V

HORIZONTAL:

Point A (153.1MHz)		
Ref.	VCCI-Limit (dBuV/m)	Measure (dBuV/m)
QP	50.0	27.7

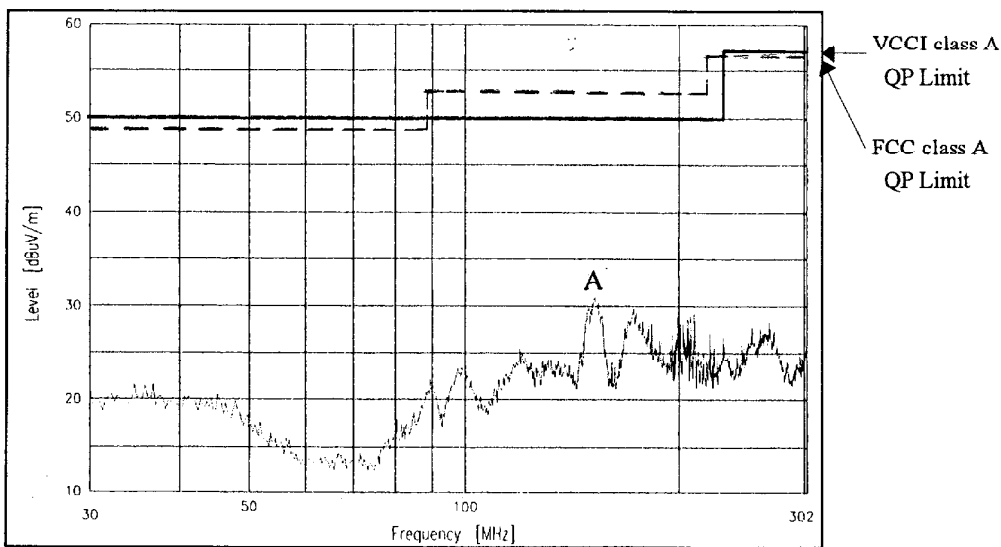

VERTICAL:

Point B (152.8MHz)		
Ref.	VCCI-Limit (dBuV/m)	Measure (dBuV/m)
QP	50.0	29.6

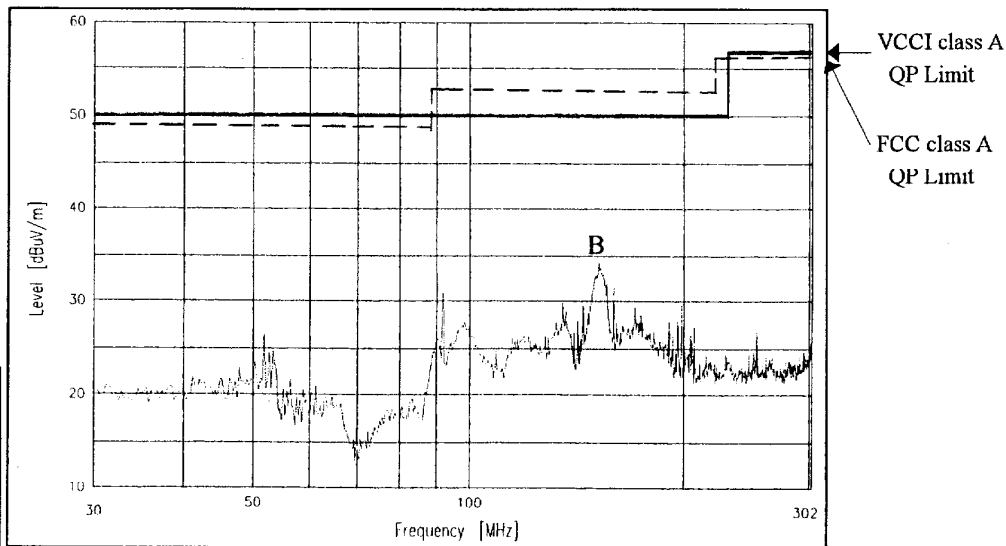

EN55011-A,EN55022-Aの限界値はVCCI class Aの限界値と同じ  
Limits of EN55011-A,EN55022-A are same as its VCCI class A.

2.17 EMI 特性

Electro-Magnetic Interference characteristics

雑音電界強度  
Radiated Emission

Conditions Vin : 100VAC  
Iout : 100%

48V

HORIZONTAL:

Point A (148.2MHz)		
Ref.	VCCI-Limit (dBuV/m)	Measure (dBuV/m)
QP	50.0	28.4

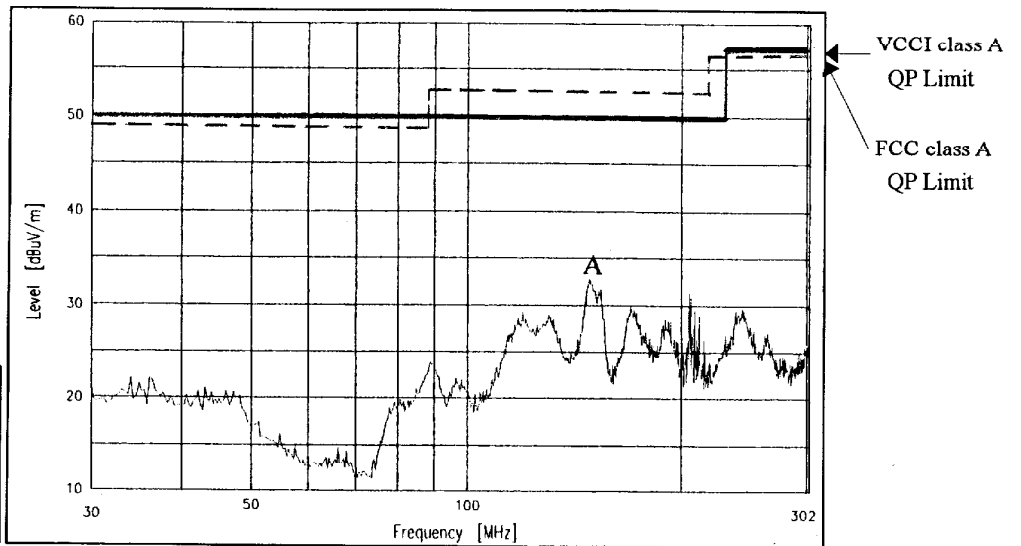

VERTICAL:

Point B (149.6MHz)		
Ref.	VCCI-Limit (dBuV/m)	Measure (dBuV/m)
QP	50.0	31.7

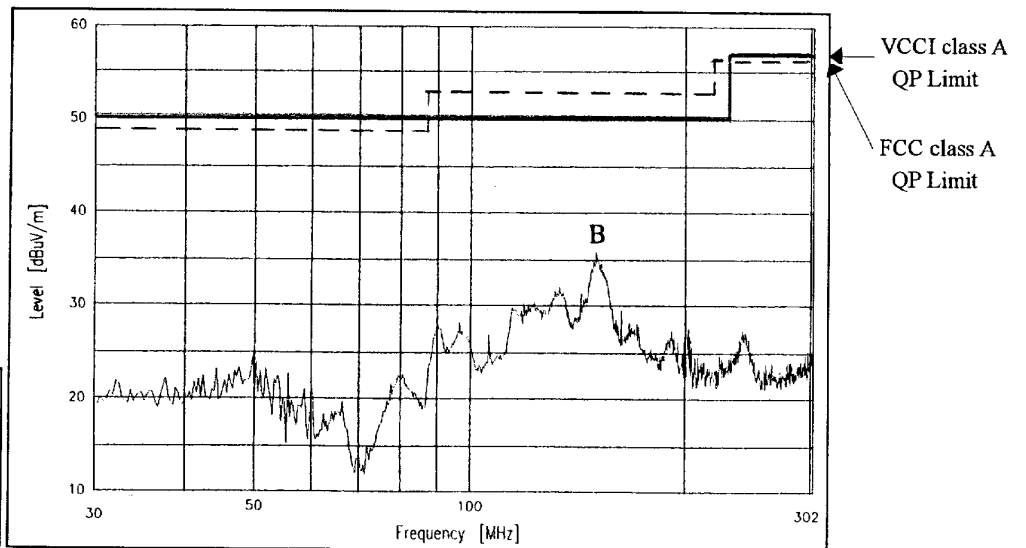

EN55011-A,EN55022-Aの限界値はVCCI class Aの限界値と同じ  
Limits of EN55011-A,EN55022-A are same as its VCCI class A.