

HFE2500 & HFE2500/S (PMBUS) SERIES INSTRUCTION MANUAL

CHAPTER 1:	HFE2500 & HFE2500/S (PMBus) SERIES SPECIFICATIONS	1
	1.1 HFE2500 rated output Current and Voltage versus Line Voltage.	3
	1.2 HFE2500 Output Power vs. Temp derating.....	4
	1.3 HFE2500 Outline Drawing	5
	1.4 Rear Panel IN/OUT Connector Pins Function Description	6
CHAPTER 2:	SAFETY APPROVALS	7
	2.1 Safety Instructions.....	7
CHAPTER 3:	SINGLE UNIT OPERATION	10
	3.1 Front Panel Indicators	10
	3.2 Single unit operation	11
	3.2.1 Basic configuration (Local Sense)	11
	3.2.2 Basic configuration (Remote Sense)	11
	3.2.3 ON/OFF Control by Enable.....	12
	3.2.4 ON/OFF Control by INHIBIT	12
	3.2.5 OUTPUT VOLTAGE PROGRAMMING by External Potentiometer	12
	3.2.6 Output Voltage Programming by External Voltage	13
	3.2.7 Output Voltage Programming by PMBus	13
	3.2.8 Over Current Programming by External Voltage.....	14
	3.2.9 Current Programming by PMBus (Optional).....	14
	3.2.10 SUPERVISORY Signals (Typical Connection).....	15
CHAPTER 4:	POWER SUPPLIES CONNECTION	16
	4.1 Parallel Operation	16
	4.2 Series Operation.....	17
CHAPTER 5:	PMBus INTERFACE OPTION	18
	5.1 HFE2500/S Series I ² C Specification	18
	5.1.1 PMBus Interface Option	19
	5.1.2 HFE2500 May Have Optional Power Management Bus Hardware	19
	5.1.3 Addressing (A3, A2, A1, A0 Inputs)	19
	5.1.4 Serial Clock.....	19
	5.1.5 Serial Data.....	19
	5.1.6 SMB Alert.....	20
	5.1.7 PMBus Typical Connection	20
	5.2 PMBus Command Set.....	20
	5.2.1 Read Status	20
	5.2.2 Clear Faults	20
	5.2.3 Operation (ON/OFF)	21
	5.2.4 Commands to Read Inventory Details	21
	5.3 Programming and Monitoring Functions	21
	5.3.1 Monitoring Output Voltage (READ_VOUT).....	21
	5.3.2 Monitoring Output Current (READ_IOUT).....	22
	5.3.3 Monitoring Supply Temperature (READ_TEMPERATURE_1)	22
	5.3.4 Programming Output Voltage (VOUT_COMMAND).....	22
	5.3.5 Programmable Maximum Output Voltage (VOUT_MAX).....	23
	5.3.6 Programming Output Current Limit.....	23
	5.3.7 Enabling / Disabling Monitoring Filter	23

CHAPTER 1: HFE2500 & HFE2500/S (PMBUS) SERIES SPECIFICATIONS

HFE2500 SERIES SPECIFICATIONS:		HFE2500-12 HFE2500-12/S	HFE2500-24 HFE2500-24/S	HFE2500-48 HFE2500-48/S		
1	Rated output voltage	V	12	24	48	
2	Output voltage set point	V	12+/-1%	24+/-1%	48+/-1%	
3	Output voltage range	V	9.6~13.2	19.2~29.0	38.4~58	
4	Rated Output Current at 180 ≤ Vin ≤ 265Vac (*1)	A	200	104	52	
5	Rated Output Current at 170 ≤ Vin ≤ 180Vac (*1)	A	200	100	50	
6	Rated Output Current at 100 ≤ Vin ≤ 132Vac (*1)	A	125	62.5	31.25	
7	Rated Output Current at 85V ≤ Vin < 100Vac (*1)	A	Linear derating 1.3% per 1Vac from output current at 100Vac.			
8	Rated output power at 180 ≤ Vin ≤ 265Vac	W	2400	2496	2496	
9	Rated output power at 170 ≤ Vin ≤ 180Vac	W	2400	2400	2400	
10	Rated output power 100 ≤ Vin ≤ 132Vac	W	1500	1500	1500	
11	Rated output power 85Vac ≤ Vin < 100Vac	W	Linear derating 1.3% per 1Vac from output power at 100Vac.			
12	Input voltage / frequency range (*2)	---	85~265Vac continuous, 47~63Hz, Single phase.			
13	Maximum input current (at 115/230Vac)	A	15/12.			
14	Power Factor (Typ.) (at 115/230Vac)	---	>0.99/0.98 at maximum output power.			
15	Efficiency at 75% rated load (Typ.) (*3)	%	90/92	90/92	91/93	
16	Efficiency at 100% rated load (Typ.) (*3)	%	89/91	89/91	90/92	
17	Inrush current (*4)	A	Less than 50.			
18	Hold-up time	mS	≥ 10mS typical at 115/230Vac input, rated output voltage and less than 80% of rated load.			
19	Maximum line regulation (*5)	%	0.25			
20	Max load regulation (*6)	%	0.50			
21	Output Ripple and noise P-P (*7)	0~+70°C	mV	240	240	480
		-10~0°C	mV	360	360	780
22	Temperature stability	---	0.05% of rated Vout for 8hrs after 30min warm-up. Constant line, load and temp.			
23	Temperature coefficient of output voltage	PPM/°C	+/-200.			
24	Remote sensing (*8)	---	Possible. Refer to Instruction Manual.			
25	Parallel operation (*9)	---	Possible. Single wire current share, 5% accuracy of rated Iout, up to 10 units of the same voltage rating.			
26	Series operation	---	Possible (with external diodes), 2 units. Refer to Instruction Manual.			
27	Over current protection	85V ≤ Vin < 132Vac	---	Minimum 105% of rated output current		
		170V ≤ Vin < 265Vac	---	105~120% of rated output current.		
28	Over voltage protection (*10)	V	Tracking OVP, range: 1.1xVout, accuracy: +/-3%, refer to Instruction Manual.			
29	Over temperature protection	---	Inverter shut down method, automatic recovery.			
30	Remote On/Off control	---	Two complementary inputs. By electrical signal or dry contact. Refer to Instruction Manual.			
31	"DC OK" signal (*14)	---	Tracking, On when Vout>90+/-5% of output voltage setting.			
32	Over-Temperature warning (*14)	---	Refer to Instruction Manual.			
33	"AC FAIL" signal (*14)	---	On when 85Vac<Vin<270Vac.			
34	Auxiliary power supply output (*3)(*11)	---	11.2~12.5V, 0.5A. 240mVp-p ripple and noise maximum.			
35	Vout programming by external voltage	---	By 0~5V, equal to Vout min ~ Vout max. Refer to Instruction Manual.			
36	Vout programming by external resistor	---	By 1Kohm potentiometer. Refer to Instruction Manual.			
37	OCP programming by external voltage	---	By 0~5V. Refer to Instruction Manual.			
38	Front panel indicators	---	AC OK, DC OK/FAIL.			
39	I ² C Interface	---	Optional, PMBus compatible. Refer to Instruction Manual.			
40	Operating temperature (*16)	---	-10~+50°C: 100% load. +50°C to +60°C Derate 2%/°C of load. +60°C to +70°C Derate 2.5%/°C of load.			
41	Storage temperature	---	-30~85°C			
42	Operating humidity	---	10~90% RH, no condensation.			
43	Storage humidity	---	10~95% RH, no condensation.			
44	Cooling	---	By internal Fans. Variable speed control based on ambient temp and power level.			
45	Vibration	---	Built to meet IEC60068-2-64 (Basic Transportation).			
46	Shock	---	Built to meet IEC60068-2-27 (Basic Transportation).			
47	Conducted emission (*15)	---	Built to meet EN55032 Class B, FCC part 15 Class-B, VCCI Class-B.			
48	Radiated emission (*15)	---	Built to meet EN55032 Class A, FCC part 15 Class-A, VCCI Class-A.			
49	Immunity	---	Built to meet IEC61000-4-2 (Level 2,3), -3 (Level 2), -4 (Level 2), -5 (Level 3,4), -6 (Level 2), -8 (Level 4), -11.			
50	Applicable safety standards	---	UL60950-1, EN60950-1.			
51	Withstand voltage	Input-Output:	---	3000Vrms, 1min.		
		Input-Ground:	---	2000Vrms, 1min.		
		Output - Ground:	---	500Vrms, 1min.	500Vrms, 1min.	2250Vdc, 1min.
52	Insulation resistance	---	More than 100Mohm at 25°C and 70% RH. Output-Ground: 500Vdc.			
53	Leakage current (*12)	mA	Less Than 0.75/1.5 at 115/230Vac range.			
54	Weight (Typ.)	Kg	Max. 2.1.			
55	Size (W*H*D)	---	107x41x325mm. Refer to Outline Drawing.			

Notes:

- *1 Refer to Figure 1.
- *2 For cases where conformance to various safety standards (UL, EN etc.) is required, to be described as 100-240Vac (50/60Hz).
- *3 At 115/230Vac, 25°C ambient temperature.
- *4 Not applicable for the noise filter inrush current less than 0.2mS.
- *5 From 85~132Vac or 170~265Vac, constant load.
- *6 From No-load to Rated load, constant input voltage. Measured at the sensing point in Remote sense.
- *7 Measured with JEITA-RC9131A 1:1 probe with 4x270uF electrolytic capacitors and 1uF film capacitor on the output, 20MHz B.W. When Power Supplies are installed in HFE2500-S1U shelf, measured with 1uF film capacitor on the output terminals of the HFE2500-S1U.
- *8 Voltage drop on load wires: HFE2500-12: 0.25V/wire; HFE2500-24: 0.5V/wire; HFE2500-48: 1V/wire.
- *9 Accuracy applicable for load current > 50% of rated output current. Derate maximum output power by 5%.
- *10 Inverter shut down method. Reset by AC voltage recycle or by On/Off control.
- *11 Measured with JEITA-RC9131A 1:1 probe with 470uF electrolytic capacitor and 0.1uF film capacitor on the output, 20MHz B.W. Capacitors are not required when the Power Supply is installed in HFE2500-S1U shelf.
- *12 Measured according to UL, EN method at 60Hz, 25°C ambient temperature.
- *13 Measured from input-off until the output voltage drops under 5% from the nominal voltage.
- *14 Open collector signal. Maximum sink current: 10mA, maximum voltage 15V.
- *15 HFE2500 series considered as professional equipment and not intended for sale to general public.
- *16 Refer to Output Power vs. temp derating figure A, B, C (Section 1.2).

1.1 HFE2500 rated output Current and Voltage versus Line Voltage.

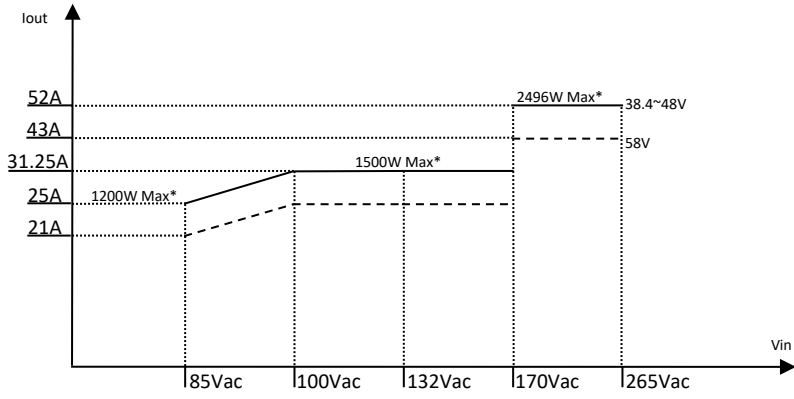

Figure 1-1: HFE2500-48; 48/S

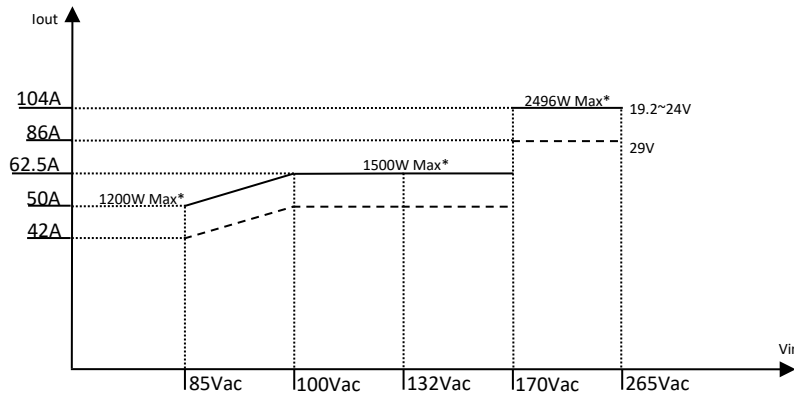

Figure 1-2: HFE2500-24; 24/S

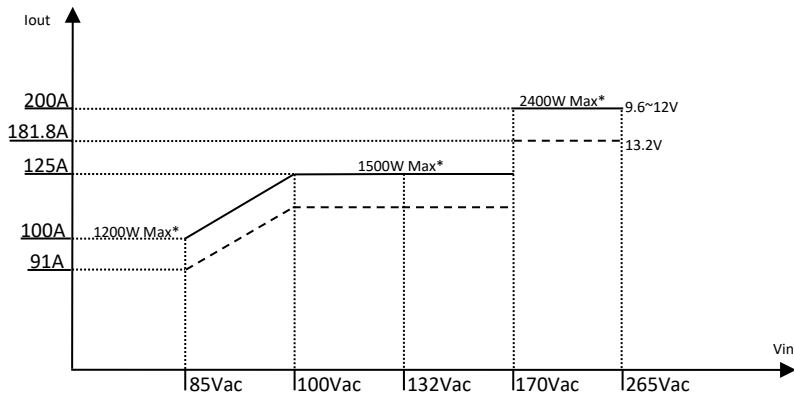

Figure 1-3: HFE2500-12; 12/S

1.2 HFE2500 Output Power vs. Temp derating.

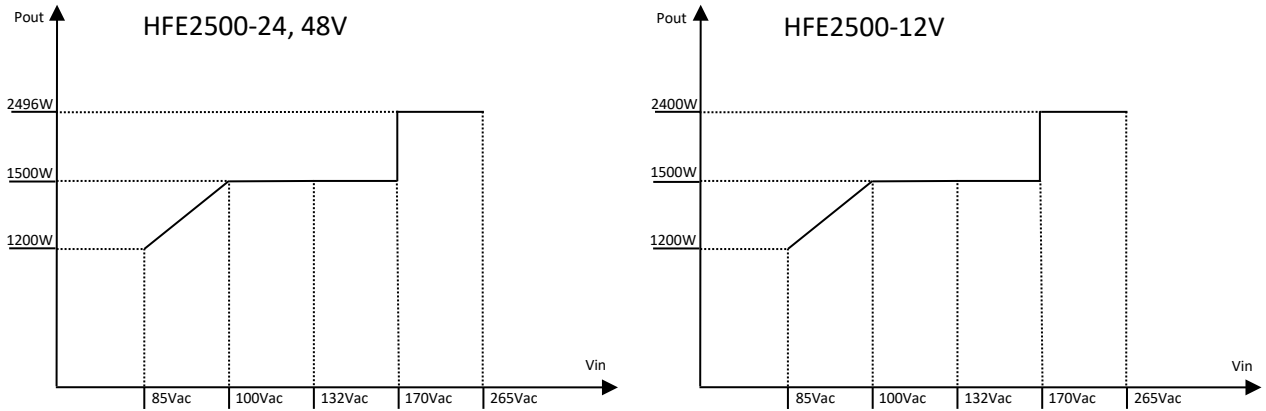

Figure 1-4: Output Power at temp -10~50°C.

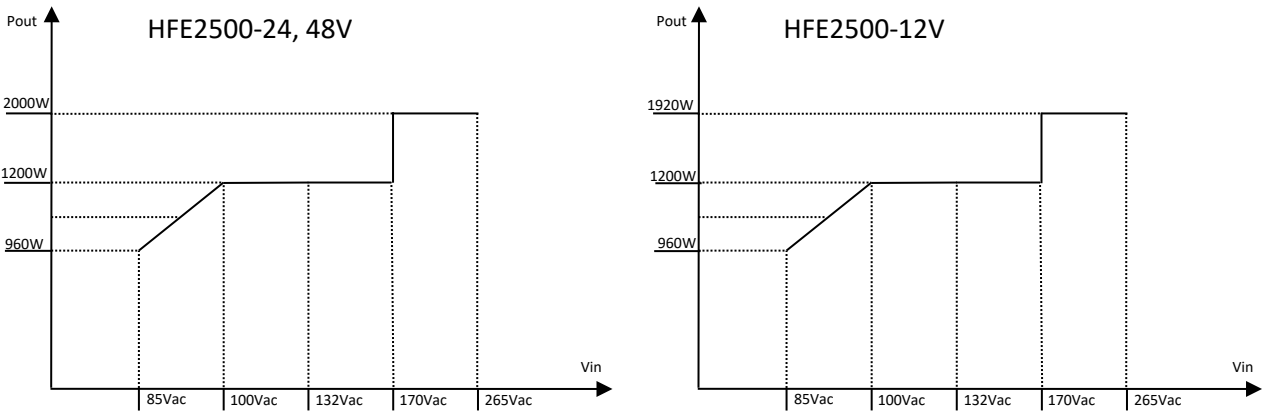

Figure 1-5: Output Power derating at temp 60°C.

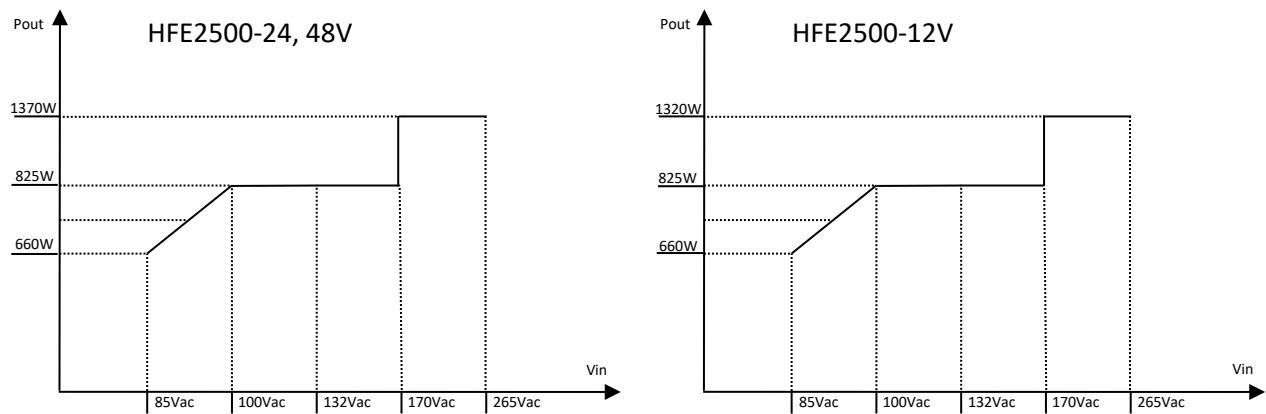
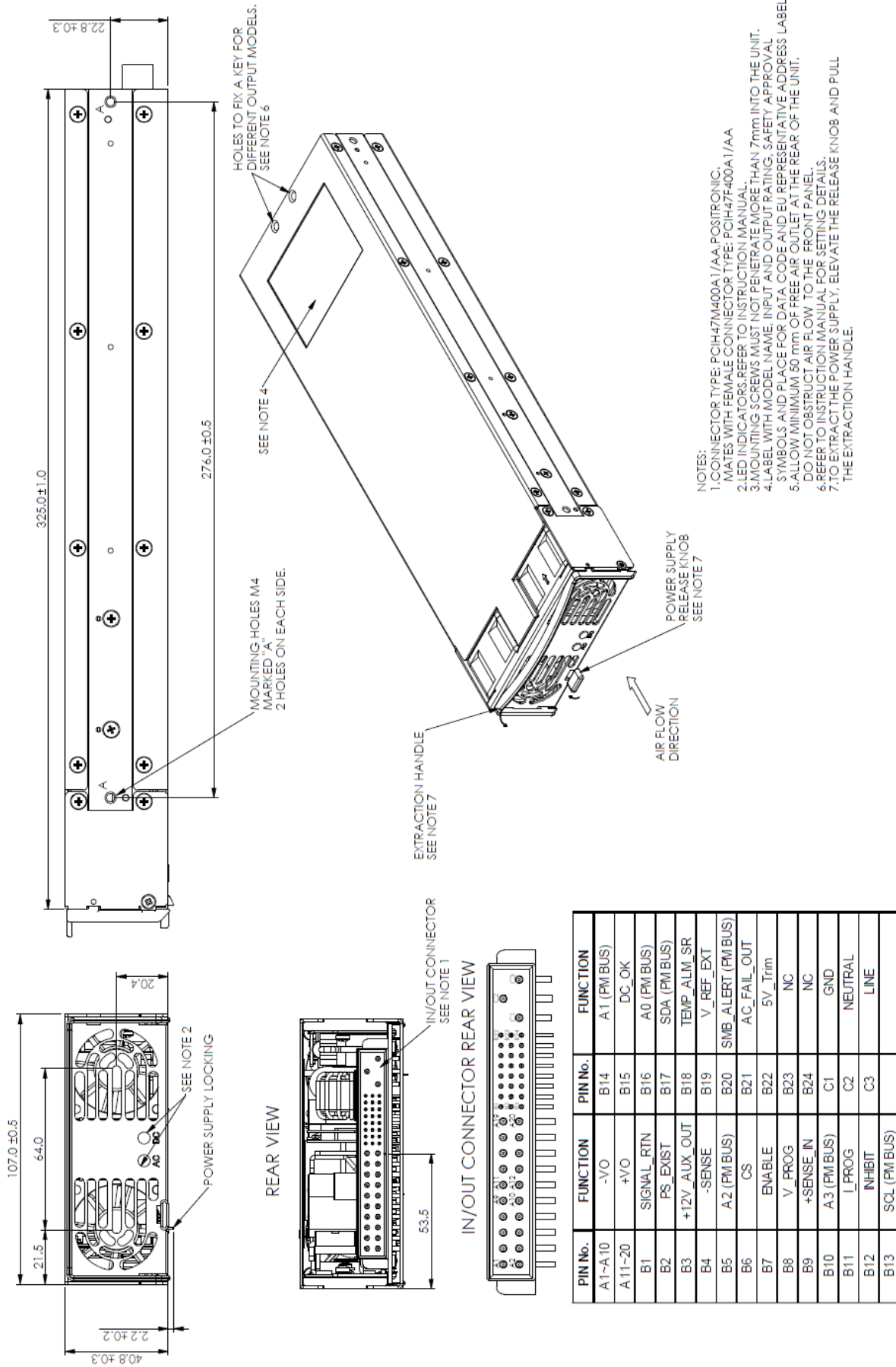

Figure 1-6: Output Power derating at temp 70°C.

1.3 HFE2500 Outline Drawing



PIN No.	FUNCTION	PIN No.	FUNCTION
A1-A10	-VO	B14	A1 (PM BUS)
A11-20	+VO	B15	DC_OK
B1	SIGNAL_RTN	B16	A0 (PM BUS)
B2	PS_EXIST	B17	SDA (PM BUS)
B3	+12V_AUX_OUT	B18	TEMP_ALM_SR
B4	-SENSE	B19	V_REF_EXT
B5	A2 (PM BUS)	B20	SMB_ALERT (PM BUS)
B6	CS	B21	AC_FAIL_OUT
B7	ENABLE	B22	5V_Trim
B8	V_FROG	B23	NC
B9	+SENSE_IN	B24	NC
B10	A3 (PM BUS)	C1	GND
B11	I_FROG	C2	NEUTRAL
B12	INHIBIT	C3	LINE
B13	SC_L (PM BUS)		

1.4 Rear Panel IN/OUT Connector Pins Function Description

Pin #	Function	Description	Referenced to
A1~A10	-V	Main Negative Output Voltage.	
A11~A20	+V	Main Positive Output Voltage.	
B1	SIGNAL RETURN	Return for the following control signals: ENABLE, INHIBIT; Supervisory signals: TEMP ALARM, AC FAIL, AUX, DC OK and PS EXIST. PMBus signals: SCL, SDA and SMB ALERT. SIGNAL RETURN and mentioned signals are isolated from the output terminals and -SENSE.	
B2	PS EXIST	Indicates that Power Supply module is inserted into the shelf. "Active Low".	SIGNAL RETURN
B3	+12V AUX OUT	11.2 ~ 12.5V Auxiliary Voltage Output. Maximum load current is 0.5A. This output has a built in O-Ring diode. Not affected by the INHIBIT/ENABLE signal or any other fault.	SIGNAL RETURN
B4	-SENSE	Negative sense. The -SENSE signal should be connected to -V on Power Supply or Load side.	-SENSE
B5,B10,B14,B16	A2,A3,A1,A0 (PMBus)	PMBus Address lines. Refer to Section 5.1.3 for Addressing.	-SENSE
B6	CURRENT SHARE	Current sharing signal should be connected when Power Supplies are connected in parallel, to allow accurate current share between units.	-SENSE
B7 (short pin)	ENABLE	Turns ON the main output by electrical signal or dry contact. ON: 0~0.6v or short; OFF: open. Requires the "ENABLE" signal to be connected to "Signal Return"	SIGNAL RETURN
B8	VOLTAGE PROGRAMMING	Input 0~5V. Provides Vout programming by Voltage. Refer to Section 3.2.5; Section 3.2.6 and Section 3.2.7.	-SENSE
B9	+SENSE	Positive sense. The +SENSE signal should be connected to +V on Power Supply or Load side.	+SENSE
B11	CURRENT PROGRAMMING	Input 0~5V. Provides Iout programming by Voltage. Refer to Section 3.2.8; Section 3.2.9.	-SENSE
B12	INHIBIT	Turns OFF the main output by electrical signal or dry contact. OFF: 0~0.6v or short; ON: open. Requires the "ENABLE" signal to be connected to "Signal Return"	SIGNAL RETURN
B13	SLC (PMBus)	Serial Clock signal. Refer to Section 5.1.4.	SIGNAL RETURN
B15	DC OK	DC OK signal. LOW when the output voltage is higher than 90% ± 5% of set Vout. Open collector type (15V, 10mA).	SIGNAL RETURN
B17	SDA (PMBus)	Serial Data signal. Refer to Section 5.1.5.	SIGNAL RETURN
B18	TEMPERATURE ALARM	TEMP ALARM signal. LOW when the internal temperature is within safe limit; HIGH approx. 10°C below Thermal shut down. Open collector type (15V, 10mA).	SIGNAL RETURN
B19	V_REF	Variable output for Voltage/Current programming with PMBus option.	-SENSE
B20	SMB ALERT (PMBus)	PMBus INTERRUPT signal. Refer to Section 5.1.6.	SIGNAL RETURN
B21	AC FAIL	AC FAIL Signal; LOW when the input voltage is 85Vac<Vin<270Vac; HIGH when the input voltage is 85Vac>Vin or Vin>270Vac. Open collector type (15V, 10mA).	SIGNAL RETURN
B22	+5V_TRIM	5V fixed output, 5mA Refer to Instruction Manual	-SENSE
B23, B24	NOT CONNECTED		
C1 (long pin)	PROTECTIVE GROUND	AC GROUND. Refer to Section 2.1 for Safety Instructions.	
C2 (long pin)	AC NEUTRAL	AC NEUTRAL. Refer to Section 2.1 for Safety Instructions.	
C3 (long pin)	AC LINE	AC LINE. Refer to Section 2.1 for Safety Instructions.	

Table 1-1: Rear panel IN/OUT pins



Figure 1-7: IN/OUTPUT CONNECTOR POSITRONIC P/N: PCIH47M400A1/AA

CHAPTER 2: SAFETY APPROVALS

UL 60950-1 and CSA22.2 No.60950-1 - UL Recognized. C-UL for Canada.

IEC 60950-1 - CB Report and Certificate.

EN 60950-1 - CE mark.

Marking by the CE Symbol indicates compliance to the Low Voltage Directive of the European Union.

A "Declaration of Conformity" in accordance with the preceding directives and standards has been made and available on file at our EU representative TDK LAMBDA GERMANY GmbH, located at Karl-Bold-Str. 40, D-77855 Achern.

A "Declaration of Conformity" may be accessed via company website www.emea.tdk-lambda.com/manual.

2.1 Safety Instructions

CAUTION: The following safety precaution must be observed during all phases of operation, service and repair of this equipment. Failure to comply with the safety precautions or warnings in this document violates safety standards of design, manufacture and intended use of this equipment and may impair the built-in protections within. TDK Lambda shall not be liable for user's failure to comply with these requirements.

Vorsicht

Die folgenden Sicherheitsvorschriften müssen vor Inbetriebnahme und in jedem Betriebszustand bei Service oder Reparatur beachtet werden. Missachtung der Sicherheitsvorschriften und Warnhinweise aus diesem Handbuch führen zur Verletzung der bestehenden Sicherheitsstandards. Bei Betrieb des Gerätes ausserhalb dem bestimmungsgemässen Einsatz können die im Gerät integrierten Schutzfunktionen beeinträchtigt werden.

TDK-Lambda ist nicht haftbar für Schäden, die durch Missachtung dieser Sicherheitsvorschriften entstehen können.

CAUTION: HFE2500-xy units are not authorized for use as critical component in nuclear control systems, life support systems or equipment for use in hazardous environments without the express written approval of the managing director of TDK-Lambda.

Vorsicht

Dieses Produkt ist nicht für die Verwendung als kritische Komponente in nuklearen Steuerungssystemen, lebenserhaltenden Systemen oder Geräte für den Einsatz in gefährlichen Umgebungen, ohne die ausdrückliche schriftliche Genehmigung durch TDK-Lambda zugelassen.

POWER SYSTEM, OVERVOLTAGE CATEGORY & ENVIRONMENTAL CONDITIONS

The HFE2500-xy units have been evaluated for using in TT and IT (230VAC line - to - line) power systems.

The HFE2500-xy units have been evaluated to Overvoltage category II.

The HFE2500-xy units intended for use in the following operation conditions:

* Indoor use * Pollution degree 2 * Max. Operational altitude: 3000m above sea level

* Ambient temperature: -10°C-50°C at 100% load, up to 70°C with output de-rating applied (refer to Specification above).

GROUNDING

HFE2500-xy units are Class I product. To minimize electrical shock hazard, the HFE2500-xy units must be connected to an electrical ground. The instruments must be connected to the AC power supply mains through a three conductor power cable, with the ground wire firmly connected to an electrical ground (safety ground) at the power outlet. For instruments designed to be hard-wired to the supply mains, the protective earth terminal must be connected to the safety electrical ground before any other connection is made. Any interruption of the protective ground conductor or disconnection of the protective earth terminal will cause a potential shock hazard that might cause personal injury.

Erdungskonzept

Dieses Produkt ist ein Gerät der Schutzklasse 1. Zur Vermeidung von gefährlichen Energieinhalten und Spannungen, ist das Gehäuse an eine Schutz Erde anzuschliessen. Der PE-Anschluss ist an einen festen Erder anzuschliessen. Bei Festverdrahtung des Gerätes ist sicherzustellen, dass der PE Anschluss als erstes angeklemt wird. Jede mögliche Unterbrechung des PE-Leiters oder Trennung der PE Verbindung kann einen möglichen elektrischen Schlag hervorrufen, der Personenschäden zur Folge hätte.

LIVE CIRCUITS

Operating personnel must not remove the HFE2500-xy unit cover.

No internal adjustment or component replacement is allowed by non-TDK Lambda qualified service personnel. Never replace components with power cable connected. To avoid injuries, always disconnect power, discharge circuits and remove external voltage sources before touching components.

Restricted Access Area: HFE2500-xy units should only be installed in a Restricted Access Area. Access should be available to service personnel only.

Spannungsführende Teile

Die Geräteabdeckung darf nicht durch Endanwender geöffnet werden. Interne Modifikationen, sowie Bauteilaustausch ist nur durch TDK-Lambda qualifiziertes Personal erlaubt. Vor Austausch von Bauteilen ist das Netzkabel bzw. die Versorgungsspannung zu trennen. Energieversorgungsanschlüsse sind immer zu trennen, um Personenschäden durch gefährliche Energieinhalte und Spannungen auszuschliessen. Die Stromkreise sind zu entladen, externe Spannungsquellen sind zu entfernen, bevor auf Bauteile bzw. Komponenten Ebene gearbeitet wird.

PARTS SUBSTITUTIONS & MODIFICATIONS

Parts substitutions and modifications are allowed to authorized TDK Lambda service personnel only. For repairs or modifications, the instrument must be returned to TDK Lambda service facility.

AC INPUT

Do not connect HFE2500-xv unit to mains supply exceeding the input voltage and frequency rating. The input voltage and frequency rating is: 100-240V~, 50/60Hz. For safety reasons, the mains supply voltage fluctuations should not exceed ±10% of nominal voltage.

HEAT HAZARD

WARNING: Top, bottom and side surfaces may become hot when operating the unit continuously. To reduce the risk of injury from a hot surface, allow the surface to cool before touching.

Heisse Oberflächen

WARNUNG: Im Dauerbetrieb erwärmen sich die Gehäuseoberflächen. Um das Verletzungs-Risiko durch heisse Oberflächen zu minimieren, sollte das Gerät einige Zeit abkühlen können, bevor weitere Arbeiten durchgeführt werden.

ENERGY HAZARD

The main output of HFE2500-xy units is capable of providing hazardous energy. Due to hazardous energy level the output and connections therefore must not be user accessible. Manufacturer’s final equipment must provide protection to service personnel against inadvertent contact with output bus bars.

FUSE

Internal fuse is sized for fault protection and if a fuse was opened it would indicate that service is required. Fuse replacement should be made by qualified technical personnel. HFE2500-xy unit fuse rating is described below. F101: F25A H 250Vac.

SICHERUNGEN

Vor Anschluss an die Netzversorgung ist die Aufstellanleitung zu beachten!

1. Absicherung: F1 01: F25A H 250VAC
2. Die Gehäuseabdeckung darf nur im stromlosen Zustand geöffnet werden.

ACHTUNG: Sicherungen dürfen nur durch geschulte Service Personen getauscht werden.









OVERCURRENT PROTECTION:

A readily accessible branch circuit over-current protective device rated 30A max. Must be incorporated in the building wiring. The protective device must be disconnect both supply line simultaneously.

Überstromschutz

Eine leicht zugängliche Vorsicherung mit 30A max.. pro Eingang muss in der Hausinstallation vorgesehen werden

SYMBOLS/ ZEICHEN:

	<p>Caution, risk of danger. Instruction manual symbol. The instrument will be marked with this symbol when it is necessary for the user to refer to the Safety & Installation or Instruction manual.</p> <p>Achtung Gefahr. Symbol im Benutzerhandbuch. Das Gerät wird mit diesem Symbol gekennzeichnet, wenn der Benutzer auf das Sicherheits- & Installationshandbuch oder die Bedienungsanleitung verwiesen wird.</p>
	<p>Indicates ground terminal.</p> <p>Zeigt einen Erdungsanschluss an.</p>
	<p>Protective Ground Conductor Terminal.</p> <p>Schutzleiterklemme.</p>
	<p>CAUTION Live component danger due to electric shock or energy content.</p> <p>VORSICHT Spannungsführende Teile-Gefahr durch elektrischen Schlag bzw. Energieinhalte.</p>
	<p>Indicates the presence of a hot surface or component. Touch of a hot surface can cause injury.</p> <p>Dieses Symbol weist auf das Vorhandensein einer heißen Oberfläche oder Komponente. Das Berühren dieser Oberfläche kann zu Verletzungen führen.</p>
	<p>Direct current (DC).</p> <p>Gleichstrom (DC).</p>
	<p>Alternate current (AC).</p> <p>Wechselstrom (AC).</p>
	<p>Denotes hazard. A procedure requires specific attention. Not following the procedure correctly could result in a personal injury. A WARNING sign should not be skipped and all indicated conditions must be fully understood and met.</p> <p>Weist auf Gefahren hin, die eine besondere Aufmerksamkeit erfordern. Eine Nichteinhaltung dieser Vorgehensweise, kann zu Körperverletzungen führen. Ein WARN-Hinweis sollte nicht übergangen und alle angeführten Bedingungen müssen eindeutig verstanden und umgesetzt werden.</p>
	<p>Denotes hazard. A procedure requires specific attention. Not following the procedure correctly could result in damage to the equipment. Do not proceed beyond a CAUTION sign until all indicated conditions are fully understood and met.</p> <p>Weist auf Gefahren hin, die eine besondere Aufmerksamkeit erfordern. Wenn die beschriebene Vorgehensweise nicht korrekt durchgeführt wird, kann dadurch das Gerät beschädigt werden. Führen Sie einem VORSICHTS-Hinweis erst durch, wenn Sie alle angezeigten Handlungen eindeutig verstanden und umgesetzt haben.</p>

CHAPTER 3: SINGLE UNIT OPERATION

3.1 Front Panel Indicators

1. DC OK – LED indicator:

GREEN Output Voltage is above $90\% \pm 5\%$ of set Output Voltage.

RED Output Voltage is below $90\% \pm 5\%$ of set Output Voltage.

2. AC OK – LED indicator:

GREEN Input Voltage (V_{in}) is in the range of 85Vac to 270Vac.

OFF Input Voltage (V_{in}) is below 85Vac or above 270Vac.

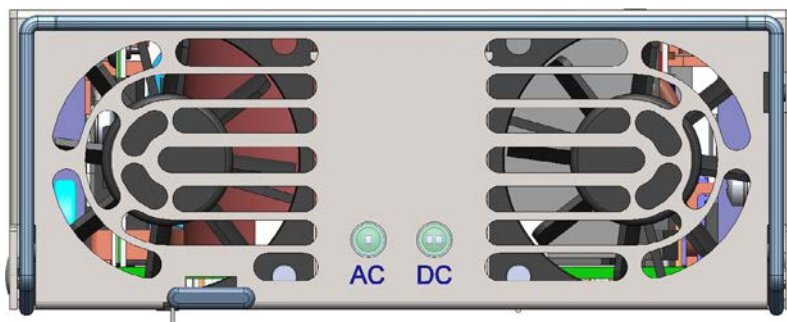

Figure 3–1: Front Panel Indicators

CAUTION:

When inserting a power supply into the rack, do not use unnecessary force; Slamming the power supply into the rack can damage the connectors on the rear of the supply and inside the rack.

ATTENTION:

Power supplies are factory programmed to the rated output voltage. For applications requiring lower / higher voltage, power supplies should be adjusted to the required voltage before connection to the load.

3.2 Single unit operation

3.2.1 Basic configuration (Local Sense)

- \pm SENSE have to be connected to the HFE2500 \pm V terminals prior to operating the supply.
- ENABLE input must be connected to SIGNAL RETURN in order for the supply to turn on.

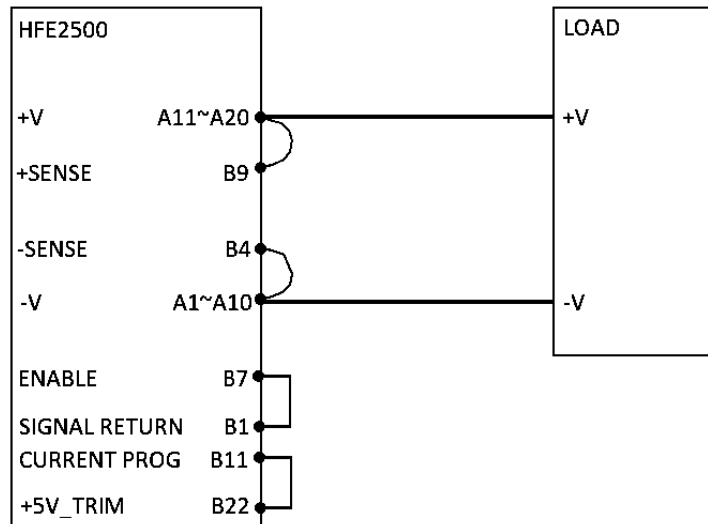

Figure 3-2: Local Sense Connection

3.2.2 Basic configuration (Remote Sense)

- \pm SENSE have to be connected to the \pm V terminals on the Load side prior to operating the supply.
- ENABLE input must be connected to SIGNAL RETURN in order for the supply to turn on.

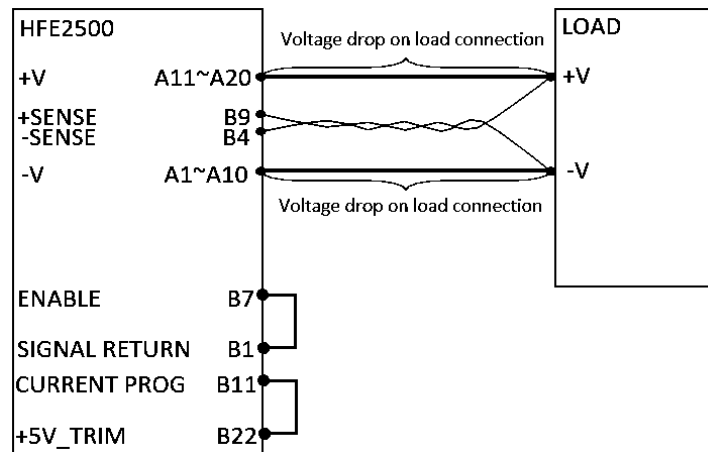

Figure 3-3: Remote Sense Connection

ATTENTION:

1. Maximum voltage drop on load connection:
HFE2500-12: 0.25V/wire; HFE2500-24: 0.5V/wire; HFE2500-48: 1V/wire.
2. Twisted wires should be used for Remote Sensing connection.
3. If Remote Sensing is used, do not break Main Output connection.

3.2.3 ON/OFF Control by Enable

SIGNAL RETURN and ENABLE control are isolated from the output terminals and "-SENSE".

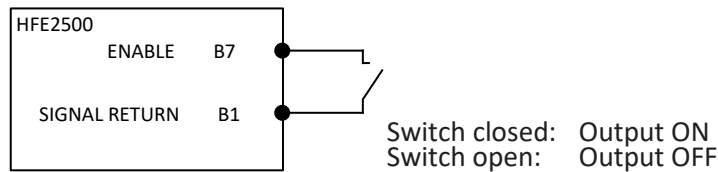

Figure 3-4: Control by ENABLE

3.2.4 ON/OFF Control by INHIBIT

Power Supply operation requires the "ENABLE" signal to be connected to "Signal Return".

Logic of the "INHIBIT" signal is reversed to logic of the "ENABLE" signal.

SIGNAL RETURN, INHIBIT and ENABLE controls are isolated from the output terminals and -SENSE.

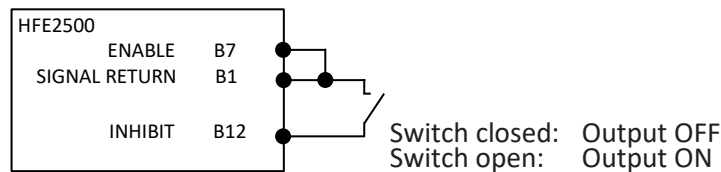

Figure 3-5: Control by INHIBIT

3.2.5 OUTPUT VOLTAGE PROGRAMMING by External Potentiometer

Output Voltage of HFE2500 Series can be trimmed by potentiometer between approximately 80%-120% for 24V, 48V and 80%-110% for 12V of nominal output voltage (For Output voltage limits see Graph below).

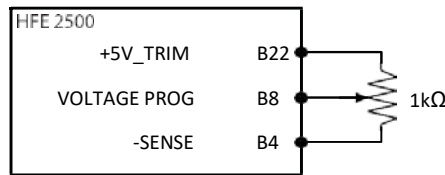

Figure 3-6: Control by Ex. Potentiometer

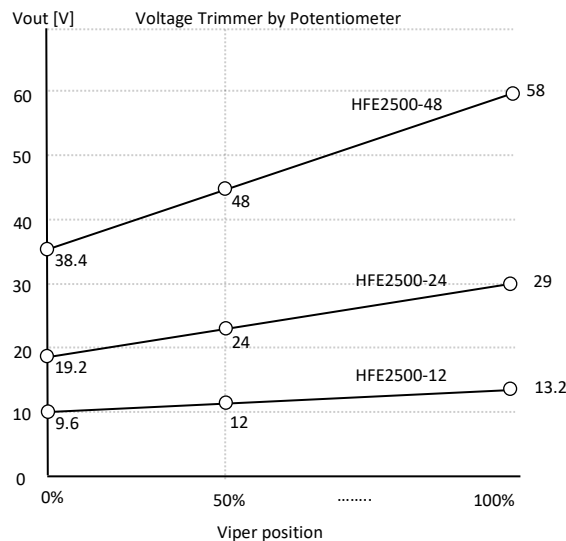

Figure 3-7: Output Voltage Limits

3.2.6 Output Voltage Programming by External Voltage

Output Voltage of HFE2500 Series can be programmed by external voltage source between approximately 80%-120% for 24V, 48V and 80%-110% for 12V of nominal output voltage (For Output voltage limits see Graph enclosed).

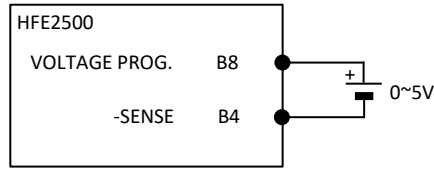

Figure 3-8: Control by Ex. Voltage

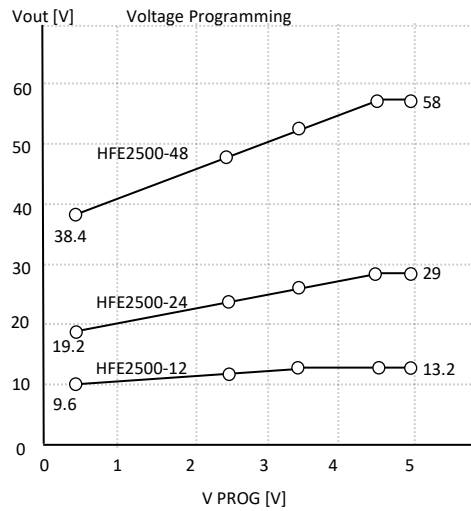

Figure 3-9: Output Voltage Limits

3.2.7 Output Voltage Programming by PMBus

Output Voltage of HFE2500 Series can be programmed by PMBus between approximately 80%-120% for 24V, 48V and 80%-110% for 12V of nominal output voltage (limits see HFE2500 series specifications line 3).

ATTENTION:

If PMBus is used for voltage programming, the Reference voltage will not be fixed to 5V but variable.

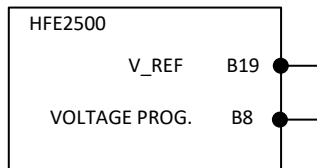

Figure 3-10: Programming by PMBus

ATTENTION:

For using sections 3.2.5; 3.2.6; 3.2.7 current programming pin (B11) must not be left open.

3.2.8 Over Current Programming by External Voltage

Over Current Protection (OCP) can be programmed by external voltage source 0~5V. Nominal OCP value is achieved by connecting to internal 5V source (V_REF, B19) or to external voltage source. By changing the Current Programming Voltage OCP level could be decreased down to ~40% of Nominal Output Current.

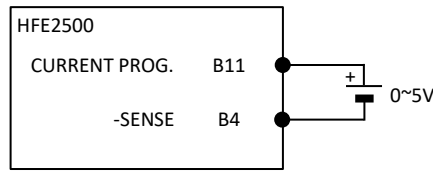

Figure 3–11: Current Programming by Ext. Voltage

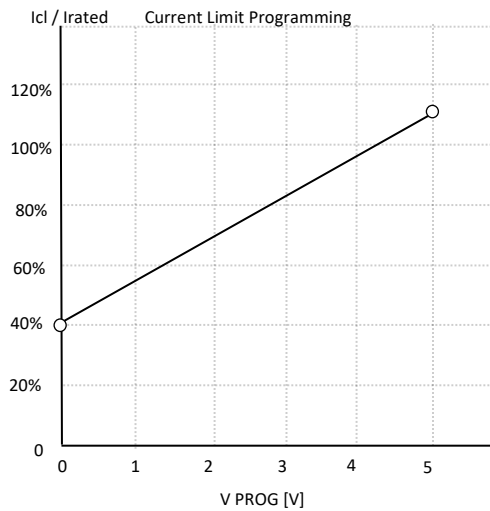

Figure 3–12: Current Limit Programming

3.2.9 Current Programming by PMBus (Optional)

Over Current Protection (OCP) can be programmed by PMBUS with a range of 50% ~ 110% of Nominal Output Current.

ATTENTION:

If PMBus is used for current programming, the Reference voltage will not be fixed to 5V but variable.

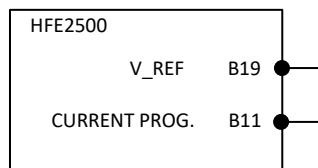

Figure 3–13: Current Programming by PMBus

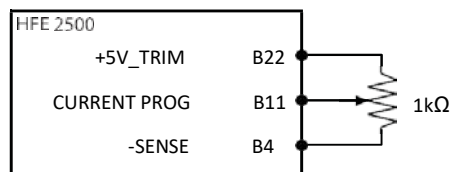

Figure 3–14: Output Current Programming by Ext. Potentiometer

3.2.10 SUPERVISORY Signals (Typical Connection)

The following supervisory signals are accessible:

- DC OK
- AC FAIL
- PS EXIST
- TEMP ALARM

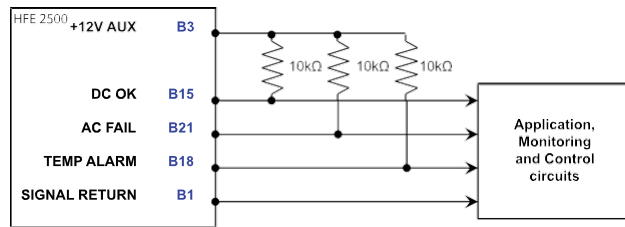

Figure 3-15: Signals

SIGNAL RETURN and mentioned signals are isolated from the output terminals and **-SENSE**.

These signals are Open Collector type (max 15V, max 10mA) shunted by internal 24V Zener, isolated from Output and referenced to "SIGNAL RETURN".

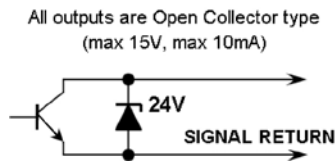
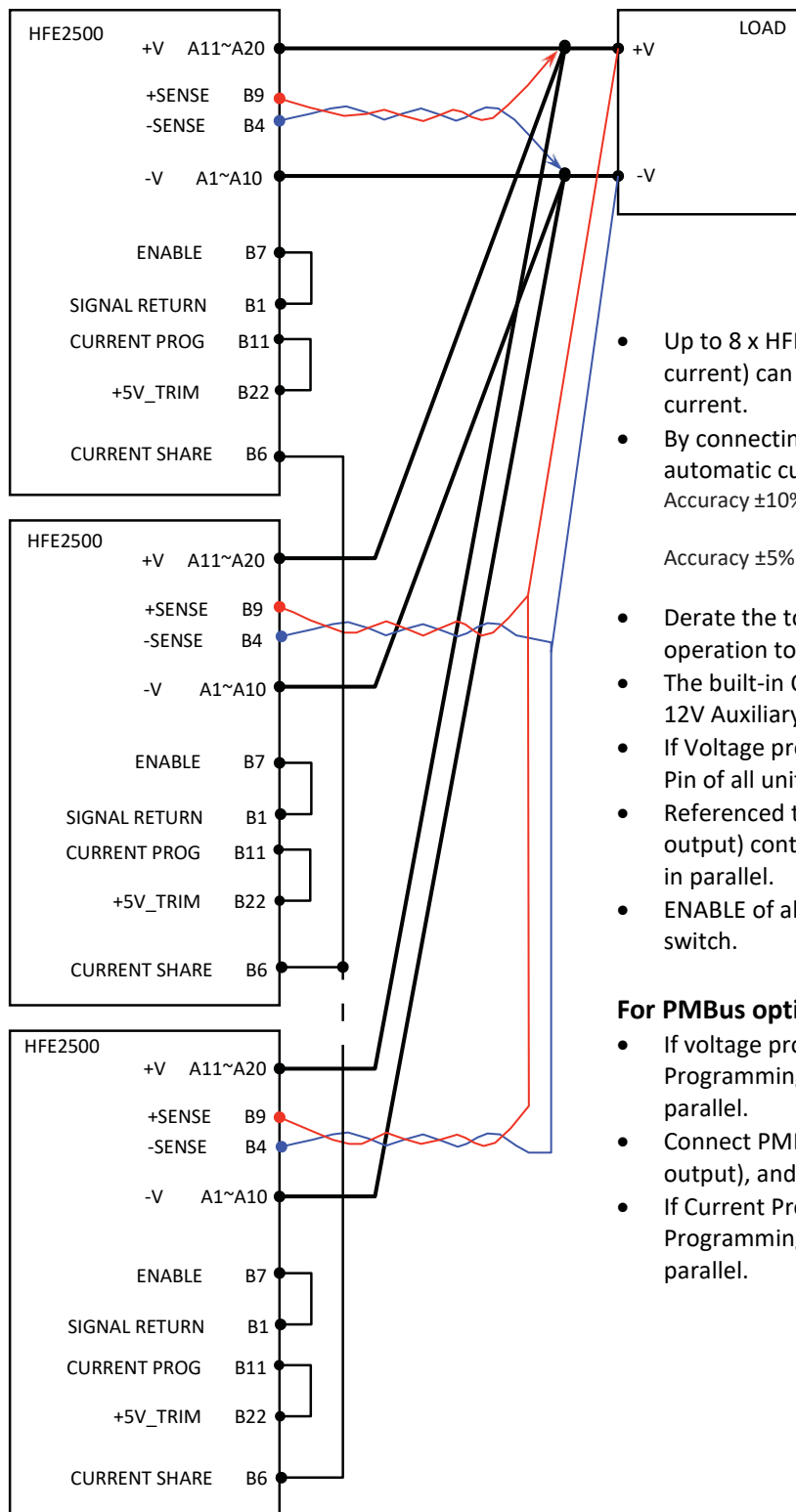

Figure 3-16: Open collector signals are shunted by internal 24V Zener

CHAPTER 4: POWER SUPPLIES CONNECTION

4.1 Parallel Operation



- Up to 8 x HFE2500 units with the same rating (voltage and current) can be used in parallel to increase the output current.
- By connecting the CS signal between the paralleled units, automatic current balance is achieved with accuracy of

Accuracy $\pm 10\%$:	20% \leq I _{out} < 50% of max I _{out} .
	Up to 10 units
Accuracy $\pm 5\%$:	I _{out} \geq 50% of max I _{out} .
	Up to 10 units.
- Derate the total output current by 5% when using parallel operation to prevent unit overload condition.
- The built-in O-Ring MOSFETs on the main output and the 12V Auxiliary output allow N+1 operation.
- If Voltage programming is used, "Voltage Programming" Pin of all units must be connected in parallel.
- Referenced to "SIGNAL RETURN" (floating from the output) controls/signals and +12V AUX can be connected in parallel.
- ENABLE of all supplies can be connected to a single switch.

For PMBus option.

- If voltage programming is done with PMBus, Voltage Programming and V_REF of all units must be connected in parallel.
- Connect PMBus Signals in parallel (PMBUS is isolated from output), and choose different address for each unit.
- If Current Programming is done with PMBUS, Current Programming and V_REF of all units must be connected in parallel.

Figure 4–1: Parallel Connection

4.2 Series Operation

- Up to 2 units with the same rating (voltage and current) can be used in series to increase the output voltage.
- Connect Main Output in series (as shown).
- Diodes should be connected in parallel with each unit output to prevent reverse voltage. Each diode should be rated to at least the power supply rated output voltage and output current.
- Connect as shown: +Sense of positive unit and –Sense of negative unit (twisted pair) to Load point, or to +V and –V accordingly for Local Sense.
- In case PMBus is used, Connect PMBus signals in parallel (PMBus is isolated from Output), and choose different address for each unit (see chapter 3).
- Output Voltage can be adjusted independently for each unit.
- Controls Monitoring signals and +12V AUX are referenced to “SIGNAL RETURN” and may be connected in parallel.

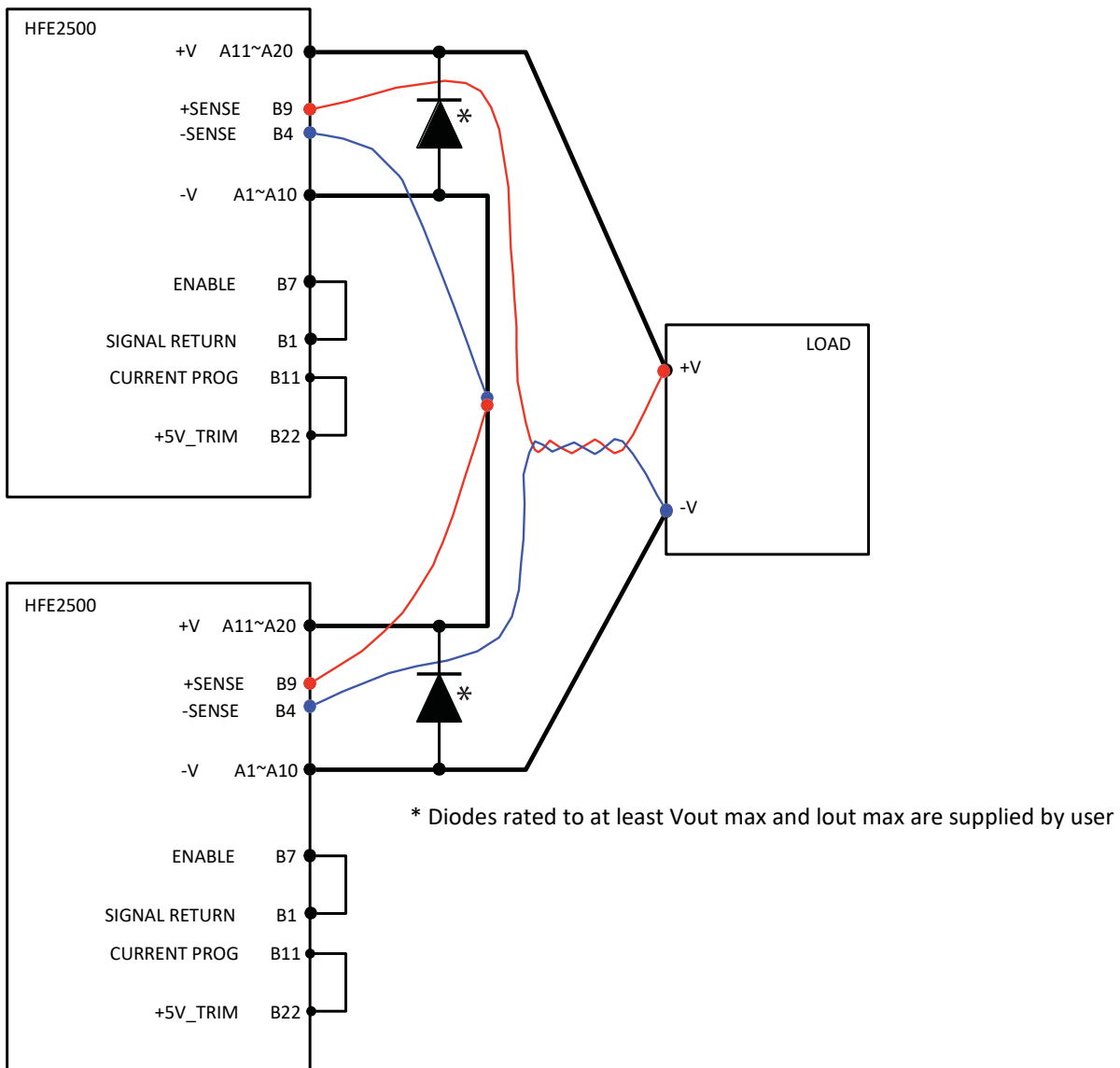

Figure 4-2: Series Connection (Remote Sense Configuration)

CHAPTER 5: PMBUS INTERFACE OPTION

5.1 HFE2500/S Series I²C Specification

1. FEATURES

1.1 Output voltage measurement
1.2 Output voltage programming.
1.3 Output current measurement
1.4 Internal ambient temperature measurement
1.5 Product information
1.6 Status information
1.7 SMBus alert
1.8 Clock frequency: 100KHz
1.9 Address lines: 4

2. OUTPUT VOLTAGE MEASUREMENT

		HFE2500-12/S	HFE2500-24/S	HFE2500-48/S
2.1 Measurement accuracy	-	+/-2% of full scale. Refer to instruction manual		
2.2 Measurement resolution	-	10 bit		
2.3 Measurement range (Full Scale, Only for Accuracy Calculation)	V	0~15	0~30	0~60

3. OUTPUT VOLTAGE PROGRAMMING

		HFE2500-12/S	HFE2500-24/S	HFE2500-48/S
3.1 Programming accuracy	-	+/-2% of full scale		
3.2 Programming resolution	-	10 bit		
3.3 Programming range	V	9.6~13.2	19.2~29.0	38.4~58

4. CURRENT LIMIT PROGRAMMING

		HFE2500-12/S	HFE2500-24/S	HFE2500-48/S
4.1 Programming accuracy	-	+/-8% of full scale		
4.2 Programming resolution	-	10 bit		
4.3 Programming range	V	50~110% of full scale		

5. OUTPUT CURRENT MEASUREMENT

		HFE2500-12/S	HFE2500-24/S	HFE2500-48/S
5.1 Measurement accuracy (*1)	-	+/-10% of full scale		
5.2 Measurement resolution	-	10 bit		
5.3 Measurement range (Full Scale, Only for Accuracy Calculation)	A	0~240	0~120	0~60

(*1) Applicable for load above 15% of nominal output current

6. INTERNAL AMBIENT TEMPERATURE MEASUREMENT

6.1 Measurement device accuracy	-	±3°C
6.2 Measurement resolution	-	10 bit
6.3 Measurement range	°C	0~100

7. PRODUCT INFORMATION

7.1 Product ID	-	Factory programmed
7.2 Model Name	-	Factory programmed
7.3 Revision	-	Factory programmed
7.4 Serial Number	-	Factory programmed
7.5 Manufacturing location	-	Factory programmed
7.6 Coefficients	-	Factory programmed
7.7 Date of Manufacture	-	Factory programmed
7.8 Nominal Output	-	Factory programmed

8. STATUS INFORMATION

8.1 "FAN FAIL" Signal	-	"1" -FAIL, "0"-OK
8.2 "DC FAIL" Signal	-	"1" -FAIL, "0"-OK
8.3 Output "OVP" Signal	-	"1"- OVP, "0"-OK
8.4 "TEMPERATURE ALARM" signal	-	"1"- ALARM, "0"-OK
8.5 "OTP" Signal	-	"1" -OTP, "0"-OK
8.6 "AC FAIL" Signal	-	"1" -FAIL, "0"-OK
8.7 I ² C ON/OFF control	-	"1" -ON, "0"-OFF

5.1.1 PMBus Interface Option

The communications bus signals are powered by an external 3.3V power source pulled up with a 1.5kΩ resistor.

5.1.2 HFE2500 May Have Optional Power Management Bus Hardware

The PMBUS interface in the HFE2500 (/S option) includes:

- Monitoring the Output Voltage, Current and Temperature.
- Programming the Output Voltage and Current.
- Programming the Maximum allowed output Voltage.
- Programming the Supply On/OFF.
- Reading and Clearing Faults.
- Reading the Manufacturing Related Data (Model Name, Serial No, Manufacturing Date, etc.).
- Storing the following conditions at AC Off.
 - Set Output voltage / Current limit (OCP).
 - Max allowed programmable output voltage.

ATTENTION:

If PMBus is used for voltage programming, the reference voltage will not be fixed to 5V but can be variable (Reference voltage will be used for voltage programming).

The PMBUS supports:

- 100 KHz Operation.
- Block Read Protocol.
- Group Command Protocol.
- Direct Data Format for Monitoring and Programming Functions.

5.1.3 Addressing (A3, A2, A1, A0 Inputs)

Four variable address lines allow up to 16 Supplies to be connected on a single bus.

PMBus uses 7 bit addressing.

There is constant part of address and variable part of address:

Constant part of address consists of 3 Most Significant Bits A6, A5, A4 always equals 001.

Variable part of address consists of 4 Least Significant bits: A3, A2, A1, and A0.

Value of these four bits have to be assigned by hardware connections of 4 pins of the PS connectors.

The Address lines (A3, A2, A1, and A0) are internally pulled up by resistors to +5V.

The address lines can be left open for <1> address or connected to -S for <0> address.

So, available Address Space contains 16 possible addresses: from 0010000 to 0011111.

In case more than one unit is connected to PMBus, each unit must be set to its own unique address.

Duplicate addressing is not allowed.

For example:	First unit - A3(J1.B10), A2(J1.B5), A1(J1.B14), A0(J1.B16) are not connected	– ADDRESS 0011111;
	Second unit - A0(J1.B16) is connected to -SENSE	– ADDRESS 0011110;
	Third unit – A1(J1.B14) is connected to -SENSE	– ADDRESS 0011101;

ATTENTION:

A3, A2, A1, A0 signals and -SENSE are NOT isolated from the Output Terminals.

Hot Plug: When hot plugging a power supply into a live system, the supply takes about 1-2 seconds to configure its address on the bus (based on the analog voltage levels present on the back plane).

5.1.4 Serial Clock

This line is clocked by the Controller which controls the PMBUS. It should be connected to +3.3V (Referenced to "Signal RTN") via a 1.5kΩ pull-up resistor.

5.1.5 Serial Data

This is a Bi-Directional line which must be connected to +3.3V (referenced to Signal RTN) via a 1.5kΩ pull up resistor.

5.1.6 SMB Alert

SMBALERT is used to indicate to the HOST about any Faults/Error Conditions. This line must be connected to +3.3V (referenced to Signal RTN) via a 1.5kΩ pull up resistor. This Signal is HIGH to indicate that no fault/error is present. If some fault/error occurs, the signal will go LOW. The Host system must poll multiple supplies after receiving SMBALERT to retrieve fault/warning information.

5.1.7 PMBus Typical Connection

"SIGNAL RETURN" and PMBus signals are isolated from the Output terminals and Senses.

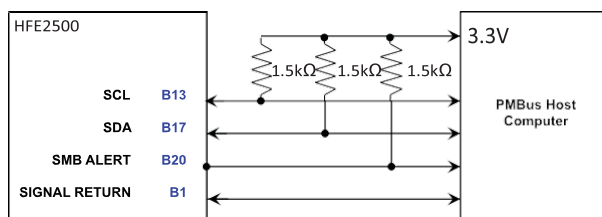

Figure 5–1: PMBus Typical Connection

5.2 PMBus Command Set

The interval between two consecutive commands to the power supply should be at least 25ms to ensure proper monitoring functionality.

5.2.1 Read Status

This Command is used to read the status of the Power Supply. The Status information is stored in a special register called the "STATUS REGISTER". The PMBUS reads 8 different types of Faults and Warnings.

Command Used	Type	#Data bytes
D0h	Read Byte	1

Fault is indicated by "1". No fault is indicated by "0".

For Example: If DC Fail occurs, READ_STATUS will return 01h. SMBALERT will go "LOW".
If AC Fail occurs, READ_STATUS will return 11h. SMBALERT will go "LOW".

Faults	Type	Bit No in Status Register	Meaning	Main Output Behavior
DC Fail	FAULT	0	Output Voltage < 85~95% of Set Vout	Output OFF/Output Low
Over Temperature Protection	FAULT	1	Internal temperature higher than safe limit	Output OFF
Over Temperature Alarm	WARNING	2	Internal temperature ~ 10°C below safe limit	Output ON
Fan Fail	FAULT	3	One or both Fans are not working	Output OFF
AC Fail	FAULT	4	Input Voltage <85Vac / >270Vac	Output OFF/Output ON
Over Voltage Protection	FAULT	5	Output Voltage > 1.15xVset	Output OFF
Programmed Voltage more than allowed	WARNING	6	Programmed Voltage more than Max Allowed Voltage (*1)	Output ON
Command Error	WARNING	7	Command not understood by Power Supply (*2)	Output ON

(*1) If Max Allowed Voltage is set to 48V and Programmed Voltage is set to 50V, Output will be programmed to 48V, Bit No 6 will be "1", and SMBALERT will become "LOW".

(*2) If any Command sent is not understood by the Supply, bit no 7 will be "1" and SMBALERT will become "LOW".

5.2.2 Clear Faults

This command is used to clear the "STATUS REGISTER" after any fault occurs. If the CLEAR_FAULTS command is not sent after any fault, the "STATUS REGISTER" will not be cleared. SMBALERT signal will remain "LOW" until "CLEAR_FAULTS" command is sent. If a Fault or Warning is still present after "CLEAR_FAULTS" is sent, "STATUS REGISTER" will be updated and the SMBALERT signal will be "LOW" again.

Command Code	Type	#Data bytes
03h	Send Byte	0

5.2.3 Operation (ON/OFF)

Command Code	Type	#Data bytes
01h	R/W Byte	00h=OFF
01h	R/W Byte	80h=ON

If the Power Supply is turned OFF with the “OPERATION OFF” command, the Supply can be turned ON with the “OPERATION ON” command only. Inhibit and Enable signals are disabled.

5.2.4 Commands to Read Inventory Details

Command Name	Command Code	Type	#Data Bytes
PMBUS_REVISION	98h	Read Byte	1
MFR_ID	99h	Read Block	16
MFR_MODEL	9Ah	Read Block	16
MFR_OUTPUT	D1h	Read Block	16
MFR_REVISION	9Bh	Read Block	16
MFR_LOCATION	9Ch	Read Block	16
MFR_DATE	9Dh	Read Block	16
MFR_SERIAL	9Eh	Read Block	20

All details except for <PMBUS_REVISION> are stored in ASCII format.

5.3 Programming and Monitoring Functions

For Monitoring and Programming functions use the following equation. This is the direct data format.

$$Y = (mX + b) * 10^R, \quad X = \frac{(Y * 10^{-R} - b)}{m}$$

Where **Y** - digital value sent or received from the supply.
X is the normal value (V, A, °C)
m, b, R - coefficients that are explained in Table 5-1.

Voltage (V)	Physical value	Physical Unit	Min. Value	Max. Value	m	b	R
48	Voltage Programming	V	38.4	58	426	-15335	-1
	Voltage monitoring	V	0	60	1705	0	-2
	Current monitoring	A	0	60	1705	0	-2
	Temperature monitoring	°C	0	100	1023	0	-2
24	Voltage Programming	V	19.2	29	853	-15360	-1
	Voltage monitoring	V	0	30	341	0	-1
	Current monitoring	A	0	120	8525	0	-3
	Temperature monitoring	°C	0	100	1023	0	-2
12	Voltage Programming	V	9.6	13.2	1705	-15345	-1
	Voltage monitoring	V	0	15	682	0	-1
	Current monitoring	A	0	240	4263	0	-3
	Temperature monitoring	°C	0	100	1023	0	-2
12, 24, 48	Current monitoring	%	50	110	146	-5830	-1

Table 5-1: Coefficients Table

m, b, R coefficients can also be recovered from the EEPROM.
 Coefficients are stored in ASCII Format.

Command Name	Command Code	Type	#Data Bytes
MFR_VOLTAGE_MON_COEFF	D2h	Read Block	16
MFR_CURRENT_MON_COEFF	D3h	Read Block	16
MFR_TEMP_MON_COEFF	D4h	Read Block	16
MFR_VOLTAGE_PROG_COEFF	D5h	Read Block	17
MFR_CURRENT_PROG_COEFF	D7h	Read Block	16

5.3.1 Monitoring Output Voltage (READ_VOUT)

The accuracy of the voltage reading is +/-2%
 The output voltage is read before the ORING Circuit (~50mV Voltage drop @ load, no drop @no load).
 The read back Output Voltage can be calculated using the “Direct data Format”.

Refer to Table 5-1 for the Coefficients for calculating the Output Voltage.

Command Code	Type	#Data Bytes
8Bh	Read Word	2

Example: Power Supply HFE2500-48;
 Hex read back = 032Ch;
 Converted to Decimal = 812;
 Using the required coefficients the Output Voltage $812 \times 100 / 1705 = 47.62V$.
 Read the Actual Output Voltage on the Output Bus Bar (Ex: 47.90V). Add 0.05V to compensate O-Ring Circuit drop.
 So, the actual voltage is (Ex: $47.90 + 0.05 = 47.95V$).
 Accuracy is $(47.95 - 47.62) / 60 (*1) \times 100 = 0.55\%$

Supply (*1)	Full Scale (*1)
HFE2500-12	15V
HFE2500-24	30V
HFE2500-48	60V

5.3.2 Monitoring Output Current (READ_IOUT)

The accuracy of the current reading is +/-10%
 The read back output current can be calculated using the “Direct data Format”.
 Refer to Table 5-1 for the Coefficients for calculating the Output Current.

Command Used	Type	#Data Bytes
8Ch	Read Word	2

Example: Hex read back = 0361h;
 Converted to Decimal = 865;
 Using the required coefficients the output current = $865 \times 1000 / 1705 = 50.73A$;
 Read the actual Output current (Ex: 50.05A) / Accuracy is $(50.05 - 50.73) / 60 (*1) \times 100 = -1.13\%$.

Supply (*1)	Full Scale (*1)
HFE2500-12	240A
HFE2500-24	120A
HFE2500-48	60A

5.3.3 Monitoring Supply Temperature (READ_TEMPERATURE_1)

The accuracy of the Temperature reading is +/-3°C
 The read back supply temperature can be calculated using the “Direct data Format”.
 Please refer to Table 5-1 for the Coefficients for calculating the Supply Temperature.

Command Used	Type	#Data Bytes
8Dh	Read Word	2

Example: Hex read back = 01DCh;
 Converted to Decimal = 476;
 Using the required coefficients the Supply Internal Temperature = $476 * 100 / 1023 = 46.53°C$.

5.3.4 Programming Output Voltage (VOUT_COMMAND)

The accuracy of the Output Voltage Programming is +/-2%
 The output Voltage can be programmed using the “Direct data Format”.
 Please refer to Table 5-1 for the Coefficients to be used for calculating the Voltage Programming.

Command Used	Type	#Data Bytes
21h	R/W Word	2

Example: Power Supply HFE2500-24;
 To program the Output Voltage to 24V, send $(853 \times 24 + (-15360)) / 10 = 511$ (DEC);
 Read the actual set output Voltage (Ex: 24.05V) / Accuracy is $(24.05 - 24) / 30 (*1) \times 100 = 0.16\%$.

Supply (*1)	Full Scale (*1)
HFE2500-12	15V
HFE2500-24	30V
HFE2500-48	60V

5.3.5 Programmable Maximum Output Voltage (VOUT_MAX)

The output Voltage can be programmed using the “Direct data Format”.
 Please refer to Table 5-1 for the Coefficients to be used for calculating the Voltage Programming.

Command Used	Type	#Data Bytes
24h	R/W Word	2

Example: Power Supply HFE2500-24;
 To program the maximum programmable output voltage to 29V.
 Send $(853 \times 29 + (-15360)) / 10 = 938$ (DEC).

5.3.6 Programming Output Current Limit

The accuracy of the Current Limit Programming is +/-8%.
 It is possible to program the OCP with the PMBUS. The OCP can be programmed between 50%~110% of nominal load current. Please refer to Fig 1 for the current limits at respective levels
 The output Current can be programmed using “Direct data Format”.
 Please refer to Table 5-1 for the Coefficients to be used for calculating the Current Programming.
 During Current programming, Vout_Max must be programmed to maximum limit.

Command Used	Type	#Data Bytes
21h	R/W Word	2

IMPORTANT:

When using the PMBUS to program the current limit, the output voltage is set to the rated value as a default.
 To set the output voltage to different level, Please refer to Section 3.2.5; 3.2.6 and 3.2.7.

Example: Power Supply HFE2500-48;
 To program the Current Limit to 100%, send $(146 \times 100 + (-5830)) / 10 = 877$ (DEC); Read the actual Current (Ex: 53A) / Accuracy is $(52 - 53) / 6 (*1) \times 100 = 1.6\%$.

Supply (*1)	Full Scale (*1)
HFE2500-12	240A
HFE2500-24	120A
HFE2500-48	60A

5.3.7 Enabling / Disabling Monitoring Filter

Monitoring filter can be enabled in order to reduce the effect of noise on the readback data.

Command Used	Type	#Data Bytes
D6h	R/W Byte	00h=OFF
D6h	R/W Word	01h=ON