



Test Report issued under the responsibility of:



TEST REPORT
IEC 62368-1
Audio/video, information and communication technology equipment
Part 1: Safety requirements

Report Number: E135494-A6017-CB-1
Date of issue.....: 2020-01-31
Total number of pages: 172

Applicant's name.....: **TDK-LAMBDA UK LTD**
Address: **KINGSLEY AVE**
ILFRACOMBE
EX34 8ES UNITED KINGDOM

Name of Test Laboratory: UL VS Limited
preparing the Report: Unit 1-3 Horizon, Wade Road, Kingsland Business Park, Basingstoke
 RG24 8AH, United Kingdom





Test specification:
Standard: IEC 62368-1:2014 (Second Edition)
Test procedure: CB Scheme
Non-standard test method: N/A

Test Report Form No.....: IEC62368_1B
Test Report Form(s) Originator: UL(US)
Master TRF.....: 2014-03

Copyright © 2014 Worldwide System for Conformity Testing and Certification of Electrotechnical Equipment and Components (IECEE), Geneva, Switzerland. All rights reserved.
 This publication may be reproduced in whole or in part for non-commercial purposes as long as the IECEE is acknowledged as copyright owner and source of the material. IECEE takes no responsibility for and will not assume liability for damages resulting from the reader's interpretation of the reproduced material due to its placement and context.
 If this Test Report Form is used by non-IECEE members, the IECEE/IEC logo and the reference to the CB Scheme procedure shall be removed.
This report is not valid as a CB Test Report unless signed by an approved CB Testing Laboratory and appended to a CB Test Certificate issued by an NCB in accordance with IECEE 02.

General disclaimer:
 The test results presented in this report relate only to the object tested.
 This report shall not be reproduced, except in full, without the written approval of the Issuing CB Testing Laboratory.
 The authenticity of this Test Report and its contents can be verified by contacting the NCB, responsible for this Test Report.

Test Item description	:	Power Supply
Trade Mark	:	TDK-Lambda TDK-Lambda
Manufacturer	:	TDK-LAMBDA UK LTD KINGSLEY AVE ILFRACOMBE EX34 8ES UNITED KINGDOM
Model/Type reference	:	NV350 or NV3 or NV-350 (these models are identical) (may be prefixed by NS - # / or - where # may be up to any four letters and may be followed by - \$; where \$ maybe any number between 000 to 999, indicating non-safety related model differences.)
Ratings	:	100-240 Vac nominal, (85-264 Vac including tolerances) 47-440 Hz, 5.5 A rms max.
Testing procedure and testing location:		
<input type="checkbox"/>	CB Testing Laboratory:	
Testing location/ address		
Tested by (name + signature)		
Approved by (name + signature)		
<input type="checkbox"/>	Testing procedure: CTF Stage 1	
Testing location/ address		
Tested by (name + signature)		
Approved by (name + signature)		
<input type="checkbox"/>	Testing procedure: CTF Stage 2	
Testing location/ address		
Tested by (name + signature)		
Witnessed by (name + signature)		
Approved by (name + signature)		
<input checked="" type="checkbox"/>	Testing procedure: CTF Stage 3	
<input type="checkbox"/>	Testing procedure: CTF Stage 4	
Testing location/ address		TDK LAMBDA UK LTD KINGSLEY AVENUE

	ILFRACOMBE DEVON EX34 8ES, UNITED KINGDOM	
Tested by (name + signature).....:	Nick Marsh / Safety Engineer	
Witnessed by (name + signature).....:	Mark John De Sagun / Project Handler	
Approved by (name + signature).....:	Dennis Butcher / Reviewer	
Supervised by (name + signature).....:	Dennis Butcher / Supervisor	

<p>List of Attachments (including a total number of pages in each attachment):</p> <p>National Differences (30 pages) Enclosures (84 pages)</p>	
<p>Summary of testing:</p>	
<p>Tests performed (name of test and test clause):</p> <p>STEADY FORCE TEST, 250 N (4.4.4.2, ANNEX T.5) STEADY FORCE TEST, 30 N (4.4.4.2, ANNEX T.3) IMPACT TEST (4.4.4.4, ANNEX T.6) CLASSIFICATION OF ELECTRICAL ENERGY SOURCES (5.2, 5.7) SEPARABLE THIN SHEET MATERIAL (5.4.4.6.2) ELECTRIC STRENGTH TEST (5.4.9) SAFEGUARDS AGAINST CAPACITOR DISCHARGE AFTER DISCONNECTION OF A CONNECTOR (5.5.2.2) RESISTANCE OF THE PROTECTIVE BONDING SYSTEM (5.6.6.2) PROSPECTIVE TOUCH VOLTAGE AND TOUCH CURRENT MEASUREMENT (5.7) INPUT TEST: SINGLE PHASE (B.2.5) NORMAL OPERATING CONDITIONS TEMPERATURE MEASUREMENT (B.2.6) SIMULATED ABNORMAL OPERATING CONDITIONS (B.3) SIMULATED SINGLE FAULT CONDITIONS (B.4) TRANSFORMER OVERLOAD (ANNEX G.5.3.3) ALTERNATIVE LOCKED-ROTOR OVERLOAD TEST FOR D.C. MOTORS (ANNEX G.5.4.6.3)</p>	<p>Testing Location: CTF Stage 3: TDK LAMBDA UK LTD KINGSLEY AVENUE ILFRACOMBE DEVON EX34 8ES, UNITED KINGDOM</p> <p>Additional tests conducted as confirmation testing for 62368 approval. See enclosure 7-03 for waiver of tests taken from 60950-1 report E135494-A57.</p> <p>Additional tests conducted as confirmation testing for 62368 approval. See enclosure 7-03 for waiver of tests taken from 60950-1 report E135494-A57.</p> <p>Additional tests conducted as confirmation testing for 62368 approval. See enclosure 7-03 for waiver of tests taken from 60950-1 report E135494-A57.</p> <p>Additional tests conducted as confirmation testing for 62368 approval. See enclosure 7-03 for waiver of tests taken from 60950-1 report E135494-A57.</p> <p>Additional tests conducted as confirmation testing for 62368 approval.</p>

LIMITED SHORT CIRCUIT TEST (ANNEX R.1,
5.6.4.1, 5.6.4.4, 5.6.5.1)

STEADY FORCE TEST, 10 N (ANNEX T.2 ,
5.4.2.6, 5.4.3.2, G.15.3.6)

See enclosure 7-03 for waiver of tests taken from 60950-1 report E135494-A57.

Summary of compliance with National Differences:

List of countries addressed: Australia / New Zealand, EU Group and National Differences, Japan, USA / Canada

EU Group and National Differences applies to CENELEC member countries: Austria , Bulgaria, Belgium, Croatia, Cyprus, the Czech Republic, Denmark, Estonia, Finland, France, Germany, Greece, Hungary, Iceland, Ireland, Italy, Lithuania, Latvia, Luxembourg, Malta, the Netherlands, Republic of North Macedonia, Norway, Poland, Portugal, Romania, Slovakia, Slovenia, Spain, Serbia, Sweden, Switzerland, Turkey and the United Kingdom

The product fulfils the requirements of: EN 62368-1:2014 + A11:2017, CSA CAN/CSA-C22.2 No. 62368-1 2nd Edition, Issued December 1, 2014

Copy of Marking Plate - Refer to Enclosure titled Marking Plate for copy.

TEST ITEM PARTICULARS:	
Classification of use by	Skilled person
Supply Connection	AC Mains
Supply % Tolerance	+10%, -10%
Supply Connection – Type	pluggable equipment type A - appliance coupler mating connector
Considered current rating of protective device as part of building or equipment installation	20 A; building;
Equipment mobility	for building-in
Over voltage category (OVC)	OVC II
Class of equipment	Class I
Access location	N/A
Pollution degree (PD)	PD 2
Manufacturer’s specified maximum operating ambient (°C)	50°C (Full Load); 65°C (Output power decreased linearly by 2.5%/°C above 50°C)
IP protection class	IPX0
Power Systems	TN
Altitude during operation (m)	5000 m
Altitude of test laboratory (m)	64 m
Mass of equipment (kg)	1 kg max
POSSIBLE TEST CASE VERDICTS:	
- test case does not apply to the test object..... :	N/A
- test object does meet the requirement :	P (Pass)
- test object does not meet the requirement :	F (Fail)
TESTING:	
Date of receipt of test item..... :	2019-08-01 TO 2019-12-18
Date (s) of performance of tests..... :	2019-09-09 TO 2019-12-18
GENERAL REMARKS:	
<p>"(See Enclosure #)" refers to additional information appended to the report. "(See appended table)" refers to a table appended to the report.</p> <p>Throughout this report a <input type="checkbox"/> comma / <input checked="" type="checkbox"/> point is used as the decimal separator.</p>	
Manufacturer’s Declaration per sub-clause 4.2.5 of IEC60335-1:	

The application for obtaining a CB Test Certificate includes more than one factory location and a declaration from the Manufacturer stating that the sample(s) submitted for evaluation is (are) representative of the products from each factory has been provided :	<input checked="" type="checkbox"/> Yes <input type="checkbox"/> Not applicable
---	--

When differences exist; they shall be identified in the General product information section.

Name and address of factory (ies) :	TDK-LAMBDA UK LTD KINGSLEY AVE ILFRACOMBE EX34 8ES UNITED KINGDOM PANYU TRIO MICROTRONICS CO LTD SHIJI INDUSTRIAL ESTATE DONGYONG NANSHA GUANGZHOU GUANGDONG 511453 CHINA
--	--

GENERAL PRODUCT INFORMATION:

Report Summary

All applicable tests according to the referenced standard(s) have been carried out.

Product Description

NV350 is a range of switching power supplies intended for building-in as component which employ isolating transformers. Reinforced insulation is provided between primary and secondary circuits. Basic insulation is provided between primary circuit and PE (Protective Earth).

Model Differences

Unit Configuration Code:

NV350 or NV3 or NV-350 (these models are identical)

(may be prefixed by NS - # / or - where # may be up to any four letters and may be followed by - \$; where \$ maybe any number between 000 to 999, indicating non-safety related model differences)

Unit Configuration Code (Description :) may be prefixed by SP followed by / or – (SP represents a sales code)

followed by: S, R, Q, P, V, C, T, U, K or L where:

Option Letter	Airflow Option
S	Forward airflow, standard fan
R	Reverse airflow, standard fan
Q	Forward airflow, quiet fan
P	Reverse airflow, quiet fan
V	Forward airflow, temperature controlled fan
C	Customer air, fan not fitted
T	Forward airflow, top fan

U Customer air, fan not fitted, cover not fitted
 K Custom fan/chassis assembly
 L Fixed speed fan (see non-standards below)

followed by: S or I where:

Option Letter	Input Option
S	Screw input terminals
I	IEC input

followed by: S, M, L, R, or T, where:

Option Letter	Leakage Option
S	Standard Leakage (Class B Filter)
M	Medium Leakage
L	Low Leakage
R	Reduced Leakage
T	Tiny Leakage

Unit configuration may be given using the above code and/or by the option description. The input terminal type (screw or IEC) may alternatively be determined by examination of the unit.

optionally followed by: EN#V, EN12V, EN13.5V, IN#V, IN12V, IN13.5V, ES#V, ES12V, ES13.5V, IS#V, IS12V or IS13.5V. Where:

Description	Option Description
EN#V	AC good, global module good, PSU enable, 5-5.5V, 2A standby output
EN*V	AC good, global module good, PSU enable, 12-13.5V, 1A standby output
IN#V	AC good, global module good, PSU inhibit, 5-5.5V, 2A standby output
IN*V	AC good, global module good, PSU inhibit, 12-13.5V, 1A standby output
ES#V	AC good, PSU enable, 5-5.5V, 2A standby output
ES*V	AC good, PSU enable, 12-13.5V, 1A standby output
IS#V	AC good, PSU inhibit, 5-5.5V, 2A standby output
IS*V	AC good, PSU inhibit, 12-13.5V, 1A standby output

Where: # represents the standby output voltage and is in the range 5 to 5.5V.

Where * represents the standby output voltage and is in the range of 12-13.5V.

The Global Options Inhibit and Enable functions permit the customer to turn off or on the main PSUs outputs and the fan. The standby supply is for use by the customer and provides an ES1 output that continues to operate when all the main PSUs outputs have been turned off using the Inhibit or Enable functions. All the functions of the Global Option pass through a single 8 way PWB socket and are all rated ES1.

NV350 Modules:

Up to 3 of the following modules types may be fitted:

@B
 or @BH

or @C

or @CM

where @ is the output voltage of the module and is within the range given in the single output module table.

or @/#DB (/ can be replaced with a _)

where @ is the output voltage of channel 1 and # is the output voltage of channel 2 of the module. Voltages are within the range given in the DB module tables.

or @/#DA (/ can be replaced with a _)

where @ is the output voltage of channel 1 and # is the output voltage of channel 2 of the module. Voltages are within the range given in the DA module tables. Only 1 DA module may be fitted.

or B/S

where B/S indicates that a blanking plate is fitted in place of a module.

The following nomenclature may optionally be used for outputs connected in series:

(Note that outputs may be connected in series even when this nomenclature is not used)

@BB or @ BHB or @BBH or @BHBH or @CC or @CCM

where @ is the total voltage of any two B, BH, C or CM modules connected in series.

or @/#BDB or @BHDB (/ can be replaced with a _)

where @ is the total series voltage of any B or BH module and DB module channel 1. # is the output voltage of the DB module channel 2. Voltages for # are within the range given in the DB module tables.

or @HDB

where @ is the total series voltage of any DB module channel 1 and channel 2.

Note.

For all outputs connected in series:

Series modules are non-standard units.

Refer to the Handbook for Energy Source Classification of series modules.

Permissible min. value for @ is given by summing the min. voltage ratings of the outputs connected in series.

Permissible max. value for @ is given by summing the max. voltage ratings of the outputs connected in series.

Custom Models:

Model: NV350 LSS 24/24DB 15.5/5.5DB (K30045A)

Maximum outputs: 24V, 1A; 24V, 0.7A; 15.5V, 6.4A; 5.5V, 6.4A. (total power 175W max.)

Maximum ambient: 50°C

Orientations: Horizontal with chassis lowest, on either side.

Comments: PSU has fan drive voltage fixed at 5.5V.

Model: NV350 LSS 24/24DB (K30045B)

Maximum outputs: 24V, 7A; 24V, 0.7A. (total power 184.8W max.)

Maximum ambient: 50°C

Orientations: Horizontal with chassis lowest, on either side.

Comments: PSU has fan drive voltage fixed at 5.5V.

Model: NV350 TSS 24B 15BH 5/15DB (K30052X, where X can be any character)

Maximum outputs: 350W max.

Comments: PSU has top fan fitted.

Compliant with EN/IEC/UL/CSA 60950-1 and 62368-1 only

Model: NV350 KISES5V 12/12DB 5B (X00004#, where # can be any number of characters)

Maximum outputs: 350W max.

Comments: PSU has top fan, at an angle fitted. Output cables of 12 to 24 AWG, max 50 cm long are supplied with this model.

Compliant with EN/IEC/UL/CSA 60950-1 and 62368-1 only

Model: NV350 NV3LISIS5V 3.3B 12BH (K30068X, where X can be any character)

Maximum outputs: 201.4W max.

Comments: PSU has fixed, reduced speed fan set to 5.5V.

Compliant with EN/IEC/UL/CSA 60950-1 and 62368-1 only

ELECTRICAL & THERMAL RATINGS:

Input Parameters

Nominal input voltage (V)	100 - 240
Input voltage range (V)	85 - 264
Input frequency range (Hz)	47 - 440*
Maximum input current (A)	5.5
Inrush Current (A)	<15

*For frequencies above 60Hz, refer to Engineering Conditions of Acceptability.

For input voltages between 85 and 89.9V the output power is derated to 94% of the values given in the Cooling Options Table.

Output Modules:

Module	Output Voltage	Slots	Maximum Average Current According to Slot Position (A)				
			Slot 1	Slot 2	Slot 3	Slot 4	Slot 5
B	3.14-3.6V	2	40	-	40	40	40
	4.75-5.5V	2	40*	-	40*	40*	40*
	7-9V	2	2.5**	-	22.5**	22.5**	22.5**

	12-15.5V	2	16***	-	16***	16***	16***
	24-28V	2	8****	-	8****	8****	8****
BH	12-15.5V	2	20#	-	20#	20#	20#
	24-28V	2	10##	-	10##	10##	10##
C	12-13.2V	3	33.34†	-	33.34†	33.34†	-
	15-16.5V	3	26.67†	-	26.67†	26.67†	-
	24-26.4V	3	16.67†	-	16.67†	16.67†	-
	27-32V	3	14.82††	-	14.82††	14.82††	-
CM	12-13.2V	3	-	33.34†††	33.34†††	33.34†††	-
	15-16.5V	3	-	26.67†††	26.67†††	26.67†††	-
	24-26.4V	3	-	16.67†††	16.67†††	16.67†††	-
	27-32V	3	-	14.82†††	14.82†††	14.82†††	-
DA CH1	11.88-12.25V	1	-	-	-	-	3¥
	11.9 to -						
DA CH2	11.6V	1	-	-	-	-	1¥¥
DB	3.14-3.6V	2	25	-	25	25	25
CH1	4.75-5.5V	2	25	-	25	25	25
	5.5-6.5V††††	2	25	-	25	25	25
	12-15.5V	2	13¥¥¥	-	13¥¥¥	13¥¥¥	13¥¥¥
	24-28V	2	7¥¥¥¥	-	7¥¥¥¥	7¥¥¥¥	7¥¥¥¥
DB	3.3-6V‡	2	10	-	10	10	10
CH2	7-15.5V	2	5	-	5	5	5
	24-32V	2	2	-	2	2	2

* - Linearly derate from 40 to 36A over the voltage range 5.2 to 5.5 V.
 ** - Linearly derate from 22.5 to 20A over the voltage range 8 to 9V.
 *** - Linearly derate from 16 to 13A over the voltage range 13.5 to 15.5 V.
 **** - Linearly derate from 8 to 7A over the voltage range 26 to 28 V.
 # - Linearly derate from 20 to 16.5A over the voltage range 13.2 to 15.5 V.
 ## - Linearly derate from 10 to 8.5A over the voltage range 25.7 to 28 V.
 † - C & CM modules may output up to 600W for up to 10 seconds providing that the converter ratings are not exceeded and the average power from the module does not exceed the following: 400W for 115 - 264Vac input or 350W for 90Vac input (average power may be linearly interpolated between 90 and 115Vac input).
 †† - Derate to 400W above 27V. C & CM modules may output up to 600W for up to 10 seconds providing that the converter ratings are not exceeded and the average power from the module does not exceed the following: 400W for 115 - 264Vac input or 350W for 90Vac input (average power may be linearly interpolated between 90 and 115Vac input).
 ††† - CM Module cannot be fitted to slot 1 due to medical spacing requirements.
 †††† - See Table below

DB modules with 6V nominal, Output Channel1

Cooling options C, S, T & V O/P 1 : 5.5 - 6V O/P 1 + O/P 2 : 195W total.
 O/P 1 : 6 - 6.5V O/P 1 + O/P 2 : Linearly derate from 195 to 170W total.
 Cooling option Q O/P 1 : 5.5 - 6V O/P 1 + O/P 2 : 180W total.
 O/P 1 : 6 - 6.5V O/P 1 + O/P 2 : Linearly derate from 180 to 140W total.
 Cooling options P & R O/P 1 : 5.5 - 6.5V O/P 1 + O/P 2 : 120W total.

DB modules with 6V nominal channel 1 are not allowed when channel 2 exceeds 5.5V.

¥ - 3A forward air, 2A reverse air.

¥¥ - 1A forward air, 0.6A reverse air.

¥¥¥ - Linearly derate from 13 to 10A over the voltage range 12.5 to 15.5 V.

¥¥¥¥ - Linearly derate from 7 to 6A over the voltage range 25 to 28 V.

‡ - Voltage measured at the module power terminals. This voltage at the power terminals must not be exceeded when remote sense is used.

Cooling Options:

Cooling option	Input volts	continuous O/P power	peak power O/P (W)	Ambient(°C)	Derating(°C) †
(S, V ,T) Forward air standard fan	90-264(Vac) ‡	350W	400 peak if 350 average #	65	2.5% per°C above 50
(S, V) Forward air standard fan	115-264(Vac)	450W	510 peak if 450 average #	65	2.5% per°C above 50
(S, V ,T) Forward air standard fan	180-264(Vac)	664W	740 peak if 600 average #	65	2.5% per°C above 50
(R) Reverse air standard fan	90-264(Vac) ‡	250W	N/A	65	2.5% per°C above 50
(Q) Forward air quiet fan	90-264(Vac) ‡	350W	N/A	65	2.5% per°C above 50
(P) Reverse air quiet fan	90-264(Vac) ‡	250W	N/A	60	3.8% per°C above 50

C, U Cooling Option : Customer air, fan not fitted. Refer to Customer Air Cooling section in for details.

† Both the total output power and the module output currents are derated by the given value.

‡ For input voltages between 85 and 89.9V the output power is derated to 94% of the values given for 90V input.

The PSU may output the given peak power for up to 10 seconds providing that the average power from the PSU does not exceed the stated value.

Continuous, peak and average power ratings may be linearly interpolated for input voltages between 90 and 180V.

Global Option standby outputs (12-13.5V at 1A or 5-5.5V at 2A) should not be included when calculating total PSU output power, but they are subject to the current deratings for operation above 50°C.

Global Options with output voltages between 5.01 and 5.5V have their max. output current linearly derated from 2A at 50°C ambient to 1.4A at 65°C ambient.

For reverse airflow cooling all B, BH and DB modules are limited to a maximum output power of 150W (total for both channels on dual output modules).

NV350 PFC

ELECTRICAL & THERMAL RATINGS:

Input Parameters

Nominal input voltage (V)	100 - 240
Input voltage range (V)	85 - 264
Input frequency range (Hz)	47 – 440*
Maximum input current (A)	5.5
Inrush Current (A)	<15

*For frequencies above 60Hz, refer to Engineering Conditions of Acceptability.

For input voltages between 85 and 89.9V the output power is derated to 94% of the values given in the Cooling Options Table.

Output Parameters

Max Output Power is 350W up to 50°C. Above 50°C, derate by 2.5%/°C.

Output Voltage - 375V +/- 20V

Fan Output - 12V nom at 0.25A max

Additional application considerations – (Considerations used to test a component or sub-assembly) -

Customer Air Cooling (options C or U):

The following method must be used for determining the safe operation of PSUs when C or U option (Customer Air) is fitted, i.e. fan not fitted to PSU. The minimum permitted airflow for customer air cooling is 0.5m/s.

For PSUs cooled by customer supplied airflow the components listed in the following table must not exceed the temperatures given. Additionally ratings specified for units with an internal fan must still be complied with, e.g. mains input voltage range, maximum output power, module voltage / current ratings and maximum ambient temperature. To determine the component temperatures the heating tests must be conducted in accordance with the requirements of the appropriate standards.

Test requirements include: PSU to be fitted in its end-use equipment and operated under the most adverse conditions permitted in the end-use equipment handbook/specification and which will result in the highest temperatures in the PSU. To determine the most adverse conditions consideration should be given to the end use equipment maximum operating ambient, the PSU/assembly loading and input voltage, ventilation, end use equipment orientation, the position of doors & covers, etc. Temperatures should be monitored using type K fine wire thermocouples (secured with cyanoacrylate adhesive, or similar) placed on the hottest part of the component (out of any direct airflow) and the equipment should be run until all temperatures have stabilized.

Circuit Ref.	Description	Max. Temperature (°C)
L2, L3, L4	Filter/PFC assy: Choke winding	155
C3, C4	Filter/PFC assy: X capacitors	100
L1	Filter/PFC assy: Boost choke winding	130
C1	Filter/PFC assy: Electrolytic capacitor	60 (105)
T1	Filter/PFC assy: Flyback transformer winding	130
RLY1	Filter/PFC assy: Relay	100
TX1, TX2	Modules: Power transformer windings	130
L1, XL1	B, BH & DB module chokes	130
L1	C & CM module chokes	140
Global option T2	Global Options: Transformer winding	90 (130)
Various	All other choke & transformer windings	110
Various	All <=10mm diameter electrolytic capacitors	80 (105)
Various	All 12.5mm diameter electrolytic capacitors	85 (105)
TX1	DA Module: Flyback transformer windings	100 (130)
XTH101	Primary IMS measured adjacent to XTH101	100 (105)

Higher temperature limit (in brackets) may be used but product life may be reduced.

The manufacturer submitted representative production sample(s) of NV350. The following sample ID 2764822 was used for construction review.

NV3SSS24/24DB24BH28BH, NV350-SSS12BH13.2B12.5/6DB and etc, were used for test purposes and are considered representative of the entire series.

Report based on testing conducted in E135494-A57 for details see list of tests.

Technical Considerations

- The product was submitted and evaluated for use at the maximum ambient temperature (T_{ma}) permitted by the manufacturer's specification of : 50°C (full load) to 65°C maximum (see cooling options for models and conditions to which the extended ambient applies) with de-ratings.
- The product is intended for use on the following power systems : TN
- Mains supply tolerance (%) or absolute mains supply values : +10%/-10%
- The equipment disconnect device is considered to be : appliance coupler (if fitted), or provided by the end equipment.

- The following were investigated as part of the protective earthing/bonding : Printed wiring board trace (refer to Enclosure - Schematics + PWB for layouts)
- The following are available from the Applicant upon request : Installation (Safety) Instructions / Manual
- The product was investigated to the following additional standards : EN 62368-1:2014 + A11:2017 (which includes all European national differences, including those specified in this test report). , CSA CAN/CSA-C22.2 NO. 62368-1 2nd Ed, Issued December 1, 2014
- Capacitors are rated for 230V due to the IT power system used in Norway. Further evaluation may be required in the end use product.
- The NV350 range is suitable for use at an altitude of 5000 metres.
- Multilayer PWB's accepted under CBTR Ref. No. E349607-A23. See enclosure 7-03 for rationale for waived tests.

Engineering Conditions of Acceptability

When installed in an end-product, consideration must be given to the following:

- The following product-line tests are conducted for this product : Earthing Continuity, Electric Strength
- The end-product Electric Strength Test is to be based upon a maximum working voltage of : Primary-Secondary: 363 Vrms, 650 Vpk;, Primary – Earthed Dead Metal: 343 Vrms, 622 Vpk
- The following output circuits are at ES1 energy levels : All except for 24VDB CH2 which is ES2
- The following output circuits are at PS3 energy levels : All circuits
- The maximum investigated branch circuit rating is : 20 A
- The investigated Pollution Degree is : 2
- Proper bonding to the end-product main protective earthing termination is : Required
- An investigation of the protective bonding terminals has : been conducted
- The following input terminals/connectors must be connected to the end-product supply neutral : N
- The following end-product enclosures are required : Mechanical, Fire, Electrical with the exception of the IEC inlet face of units fitted with an IEC60320 inlet.
- The following magnetic devices (e.g. transformers or inductor) are provided with an OBJY2 insulation system with the indicated rating greater than Class A (105°C) : T1, T2, TX1 & TX2 (all Class F). See table 1.5.1 for details of insulation systems used.
- The following components require special consideration during end-product Thermal (Heating) tests due to the indicated maximum temperature measurements during component-level testing : Refer to additional application considerations.
- The equipment is suitable for direct connection to : AC mains supply
- The power supply terminals and/or connectors are: Screw terminals (where used) are suitable for factory wiring only.
- The following output terminals were referenced to earth during performance testing: All outputs and their return lines individually referenced to obtain maximum working voltage.
- Fans: The end fan provided in this sub-assembly is provided with a fan guard to reduce the risk of accidental contact with the stator. The top fan provided in this sub-assembly is not intended for access by ordinary person.
- When operated at a frequency greater than 60Hz, evaluation of the end equipment against the requirements of clause 5.7 must be considered.

ENERGY SOURCE IDENTIFICATION AND CLASSIFICATION TABLE:	
(Note 1: Identify the following six (6) energy source forms based on the origin of the energy.) (Note 2: The identified classification e.g., ES2, TS1, should be with respect to its ability to cause pain or injury on the body or its ability to ignite a combustible material. Any energy source can be declared Class 3 as a worse case classification e.g. PS3, ES3.)	
Electrically-caused injury (Clause 5): (Note: Identify type of source, list sub-assembly or circuit designation and corresponding energy source classification) Example: +5 V dc input ES1	
Source of electrical energy	Corresponding classification (ES)
Primary circuits (Not accessible)	ES3
Input connector (Not accessible except option I (stored capacitance))	ES1
B, BH, C, CM, DB, DA modules and all options, secondary circuits before rectification (Not accessible)	ES3 (declared)
B, BH, C, CM, DB (Not 24V CH2), DA modules and all options, secondary circuits after rectification	ES1 (see Energy source diagram 'A')
BB (6.28 to 7.2, 9.5 to 11, 14 to 18, 24 to 31), BBH, BHB or BHBH (24 to 31), CC or CM (24 to 26.4, 30 to 33) BDB (6.28 to 7.2, 9.5 to 11, 24 to 31) BHDB (24 to 31) secondary circuits after rectification	ES1 (see Energy source diagram 'A')
DB (CH2 24V) BB (48 to 56), BBH, BHB or BHBH (48 to 56), CC or CM (48 to 52.8V, 54 to 64) BDB (48 to 56) BHDB (48 to 56) secondary circuits after rectification	ES2 (see Energy source diagram 'B')
Electrically-caused fire (Clause 6): (Note: List sub-assembly or circuit designation and corresponding energy source classification) Example: Battery pack (maximum 85 watts): PS2	
Source of power or PIS	Corresponding classification (PS)
All circuits	PS3 (declared)
Injury caused by hazardous substances (Clause 7) (Note: Specify hazardous chemicals, whether produces ozone or other chemical construction not addressed as part of the component evaluation.) Example: Liquid in filled component Glycol	
Source of hazardous substances	Corresponding chemical
N/A	N/A
Mechanically-caused injury (Clause 8) (Note: List moving part(s), fan, special installations, etc. & corresponding MS classification based on Table 35.) Example: Wall mount unit MS2	
Source of kinetic/mechanical energy	Corresponding classification (MS)

ENERGY SOURCE IDENTIFICATION AND CLASSIFICATION TABLE:	
Sharp edges/corners	MS1
Fan blades	MS1
Product mass	MS1
Thermal burn injury (Clause 9)	
(Note: Identify the surface or support, and corresponding energy source classification based on type of part, location, operating temperature and contact time in Table 38.)	
Example: Hand-held scanner – thermoplastic enclosure TS1	
Source of thermal energy	Corresponding classification (TS)
Metal enclosure/chassis (except Option I front panel and IEC inlet)	TS3 (declared) (accessible to skilled person only)
IEC connectors and front panel (Option I only)	TS1 (see Thermal Energy source diagram 'C')
Radiation (Clause 10)	
(Note: List the types of radiation present in the product and the corresponding energy source classification.)	
Example: DVD – Class 1 Laser Product RS1	
Type of radiation	Corresponding classification (RS)
N/A	N/A

ENERGY SOURCE DIAGRAM

Indicate which energy sources are included in the energy source diagram. Insert diagram below

ES PS MS TS RS

Electrical Energy Source Classification

Diagram 'A'

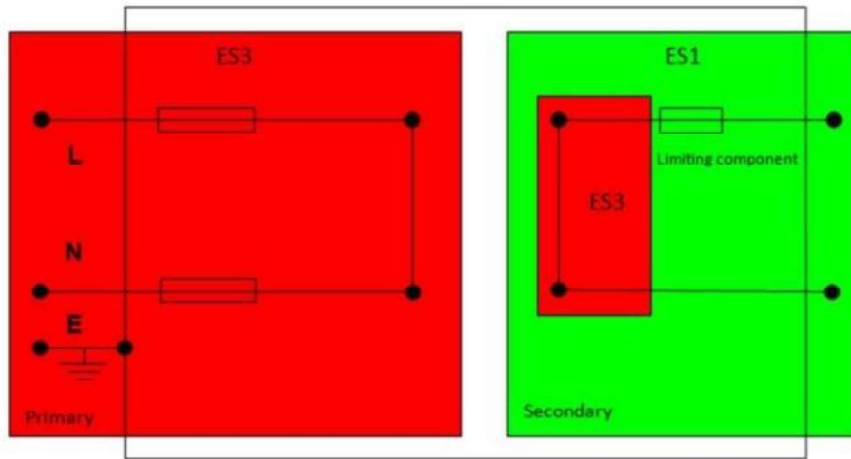
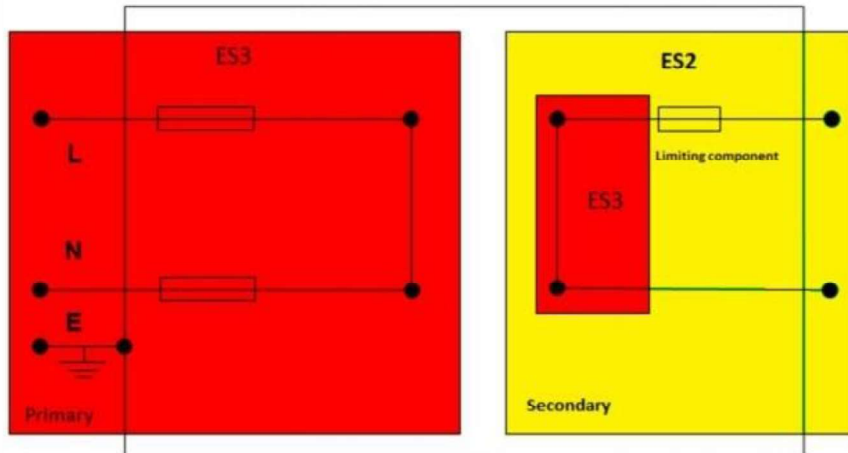
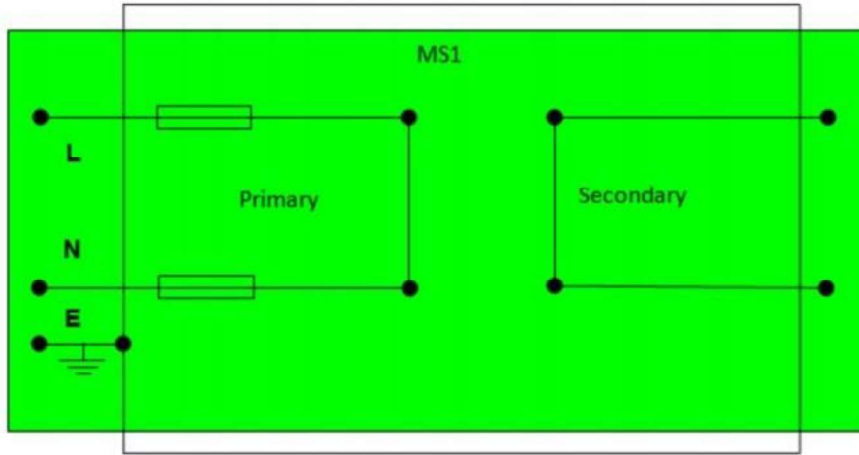

Diagram 'B'



Mechanical Energy Source Classification

All models



Power Source Classification

All models

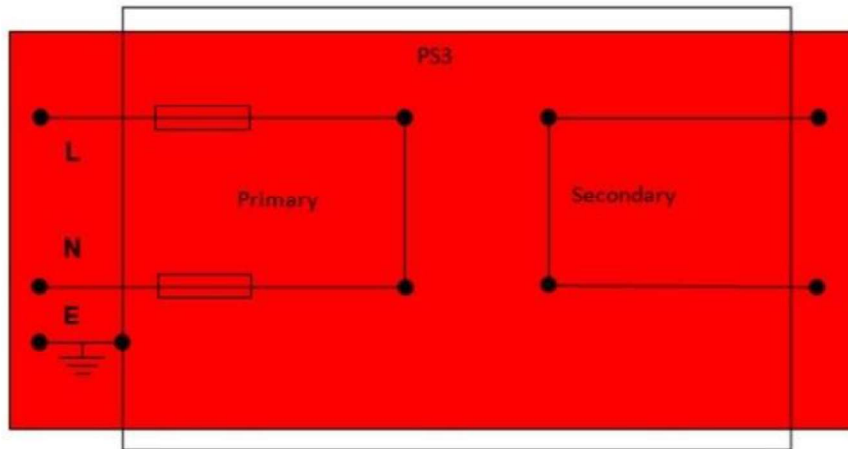

Thermal Energy Source

Diagram 'C'

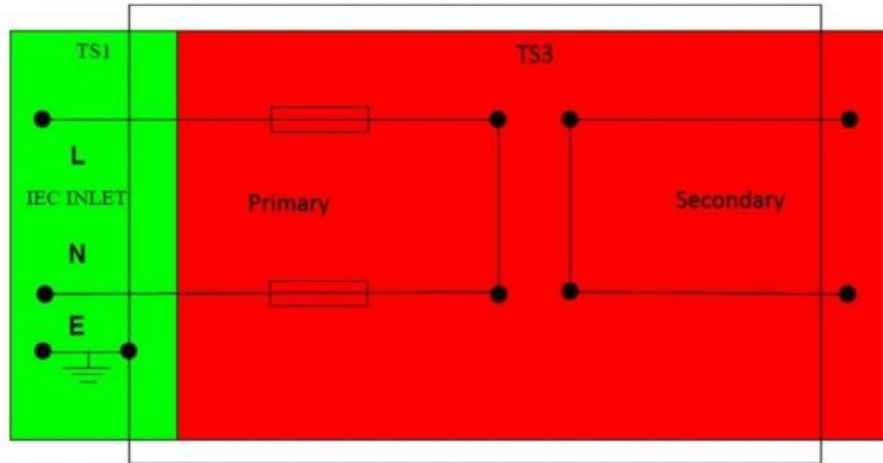

All models (except options I)

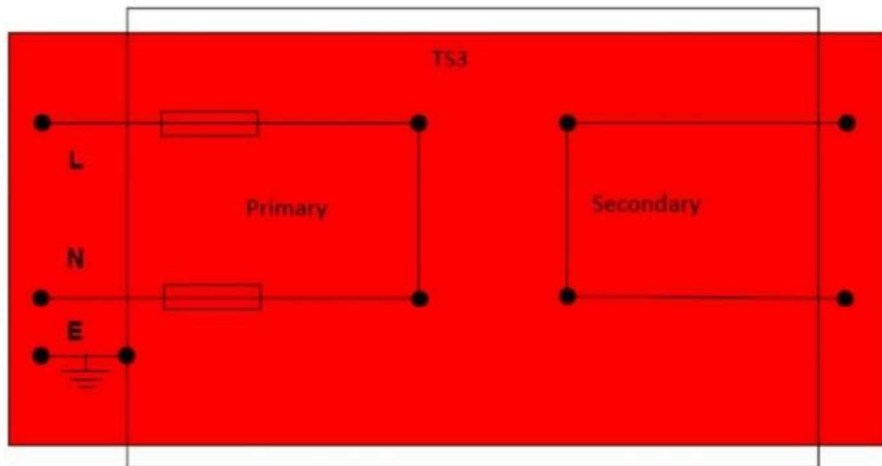

OVERVIEW OF EMPLOYED SAFEGUARDS				
Clause	Possible Hazard			
5.1	Electrically-caused injury			
Body Part (e.g. Ordinary)	Energy Source (ES3: Primary Filter circuit)	Safeguards		
		Basic	Supplementary	Reinforced (Enclosure)
Ordinary Person	ES3: Pins of input terminal (Not accessible, unit for building in except for options I)	Voltage is ES1 after 2 seconds	Voltage is ES1 after 2 seconds in SFC	N/A
Ordinary Person (outputs may be accessible)	ES3: Primary circuits	Creepage and clearance (See insulation diagram, Encl. 4-02, Areas B)	Earthed chassis	N/A
Ordinary Person (outputs may be accessible)	ES3: Primary circuits	N/A	N/A	Opto-couplers (See insulation diagram, Encl. 4-02, Area C)
Ordinary Person (outputs may be accessible)	ES3: Primary circuits	N/A	N/A	Clearance & Creepage (See insulation diagram Area E)
Ordinary Person (outputs may be accessible)	ES3: Primary circuits	N/A	N/A	TX1, TX2, T1, T2 using TIW (See insulation diagram, Encl. 4-02, Area D)
Ordinary Person (outputs may be accessible)	ES3: Primary circuits	N/A	N/A	TX1, Distance Through Insulation (See insulation diagram, Encl. 4-02, area D)
Ordinary Person (outputs may be accessible)	ES3 (Declared): Secondary circuits	N/A	N/A	Distance through insulation

				(2 layers of tape)
6.1	Electrically-caused fire			
Material part (e.g. mouse enclosure)	Energy Source (PS2: 100 Watt circuit)	Safeguards		
		Basic	Supplementary	Reinforced
Transformers T1, T2, TX1, TX2	PS3:Declared	No ignition occurred. Temperatures remained within limits during normal & abnormal conditions	Transformers comply with G.5.3.	N/A
PWB	PS3:Declared	No ignition occurred. Temperatures remained within limits during normal & abnormal conditions	Control of fire spread achieved with PWBs made of V-1 minimum	N/A
All other components	PS3:Declared	No ignition occurred. Temperatures remained within limits during normal & abnormal conditions	Mounted on V-1 minimum rated PWB. CoA requires a fire enclosure be provided by the end equipment manufacturer. Components associated with the MAINS comply with the relevant IEC component standards and/or requirements of this standard.	N/A
7.1	Injury caused by hazardous substances			
Body Part (e.g., skilled)	Energy Source (hazardous material)	Safeguards		
		Basic	Supplementary	Reinforced
N/A	N/A	N/A	N/A	N/A
8.1	Mechanically-caused injury			
		Safeguards		

Body Part (e.g. Ordinary)	Energy Source (MS3:High Pressure Lamp)	Basic	Supplementary	Reinforced (Enclosure)
Ordinary Person	MS1: Sharp edges and corners; Fan Blades; Mass	N/A	N/A	N/A
9.1	Thermal Burn			
Body Part (e.g., Ordinary)	Energy Source (TS2)	Safeguards		
		Basic	Supplementary	Reinforced
Ordinary Person	TS1: IEC Inlet and Front Panel. Table 38, row 3 TS1 limit applied: Handle, knobs, grips etc., and external surfaces touched occasionally for very short periods (>1 s and < 10 s).	Under abnormal conditions and SFC, the IEC inlet and front panel continue to comply with a TS1 limit of 60°C.	N/A	N/A
Ordinary Person	TS3: Declared (to be considered in end application). All models except Option I.	N/A	N/A	N/A
10.1	Radiation			
Body Part (e.g., Ordinary)	Energy Source (Output from audio port)	Safeguards		
		Basic	Supplementary	Reinforced
N/A	N/A	N/A	N/A	N/A
Supplementary Information:				
<p>(1) See attached energy source diagram for additional details.</p> <p>(2) "N" – Normal Condition; "A" – Abnormal Condition; "S" Single Fault</p> <p>NV350M models (except options I, IEC connections only) are accessible to Service Engineers only (skilled persons). Outputs of the power supply maybe made accessible to an Ordinary Person with-in the final unit providing it is ES1. End equipment consideration.</p>				