

AC Input

Single Output, General-Purpose

Conformity to RoHS Directive

F Series FMP/FMP-B(3 to 10W)

The F series FMP/FMP-B has realized a thickness of 20mm max. by the TDK original technology such as increased switching frequencies and a thin-type transformer or filter. It has an equivalent level of the FCC class B in the noise terminal voltage in spite of the compact size. An onboard-type FMP-B is included in the lineup.

FEATURES

- AC.100V input thin-type single output power supply.
- Compact plastic package type.
- Low price.
- Low noise (FCC class B compliant).
- It is a product conforming to RoHS directive.



PPART NUMBERS AND RATINGS

FMP

Output voltage (V)	3W Type		10W Type	
	Current(A)	Part No.	Current(A)	Part No.
5	0.06 to 0.6	FMP05-R60	0.2 to 2	FMP05-2R0
12	0.02 to 0.25	FMP12-R25	0.08 to 0.85	FMP12-R85
24	0.01 to 0.13	FMP24-R13	0.04 to 0.45	FMP24-R45

FMP-B

Output voltage (V)	3W Type		10W Type	
	Current(A)	Part No.	Current(A)	Part No.
5	0.06 to 0.6	FMP05-R60B	0.2 to 2	FMP05-2R0B
12	0.02 to 0.25	FMP12-R25B	0.08 to 0.85	FMP12-R85B
24	0.01 to 0.13	FMP24-R13B	0.04 to 0.45	FMP24-R45B

- The above products are only produced upon receipt of order. Please check a delivery date.

• Conformity to RoHS Directive: This means that, in conformity with EU Directive 2002/95/EC, lead, cadmium, mercury, hexavalent chromium, and specific bromine-based flame retardants, PBB and PBDE, have not been used, except for exempted applications.

• All specifications are subject to change without notice.

FMP3W Type

SPECIFICATIONS AND STANDARDS

Part No.		FMP05-R60 ^{*4}	FMP12-R25	FMP24-R13
Rated output voltage and current ^{*1}		5V • 0.6A	12V • 0.25A	24V • 0.13A
Maximum output power	W	3	3	3.1
Input conditions				
Input voltage Eac	V	85 to 132[Rating: 100 to 120]		
Input frequency	Hz	47 to 440[Rating: 50 to 60](Single phase)		
Input current	A	0.1max./0.08typ.[AC.85V]		
Surge current	A	16max.[Input and output ratings, 25°C, cold start]		
Leakage current	mA	0.5max.[Input and output ratings]		
Efficiency	%	68typ.	70typ.	74typ.
Output characteristics				
Output voltage Edc	V	5	12	24
Voltage variable range Edc	V	4.5 to 5.5	10.8 to 13.2	21.6 to 26.4
Maximum output current	A	0.6	0.25	0.13
Minimum output current ^{*2}	A	0.06	0.02	0.01
Overcurrent threshold	A	0.7 to 1.2	0.3 to 0.5	0.15 to 0.3
Voltage stability	Source effect	%	0.1typ.[Within the input voltage range]	
	Load effect ^{*2}	%	0.8typ.[10 to 100% load]	
	Temperature effect	%	1typ.[Ambient temperature: 0 to +50°C]	
	Drift(Time effect)	%	1max.[25°C, input and output ratings, after input voltage ON for 30min to 8h]	
	Recovery	%/ms	±4max./1min.[50 to 100% sudden load change]	
Ripple Ep-p	mV	50max.	80max.	100max.
Ripple noise Ep-p	mV	100max.	150max.	150max.
Start up time	ms	100max.		
Hold up time	ms	20min.		
Auxiliary functions				
Indicator display		No		
Overvoltage protection		Uses overvoltage prevention. ^{*3}		
Overcurrent protection		Rectangular type, automatic recovery.		
Remote ON-OFF		No		
Remote sensing		No		
Output voltage external variable function		No		
Standards				
Safety standards		—		
Noise terminal voltage		FCC class B meet.		
Constructions				
External dimensions	mm	19×55×50[H×W×L](Except input and output terminals)		
Weight	g	80max.		
Mounting method		Can be attached to 1 side.		
Case material		Nonflammable resin.		
Input and output cables		No		

^{*1} Current rating(maximum output current) is determined for 0 to +50°C. Derating is required when used outside this temperature range.

^{*2} The output load variation is determined within the range set by the minimum output current and the maximum output current. Nominal values might possibly not be satisfied when output is below the minimum output current.

^{*3} Although there is no built-in overvoltage protection circuit, the overvoltage prevention method is used for circuit design, thereby preventing overvoltage.

^{*4} Output may fail to come on when operated in series.

FMP3W Type

SHAPES AND DIMENSIONS

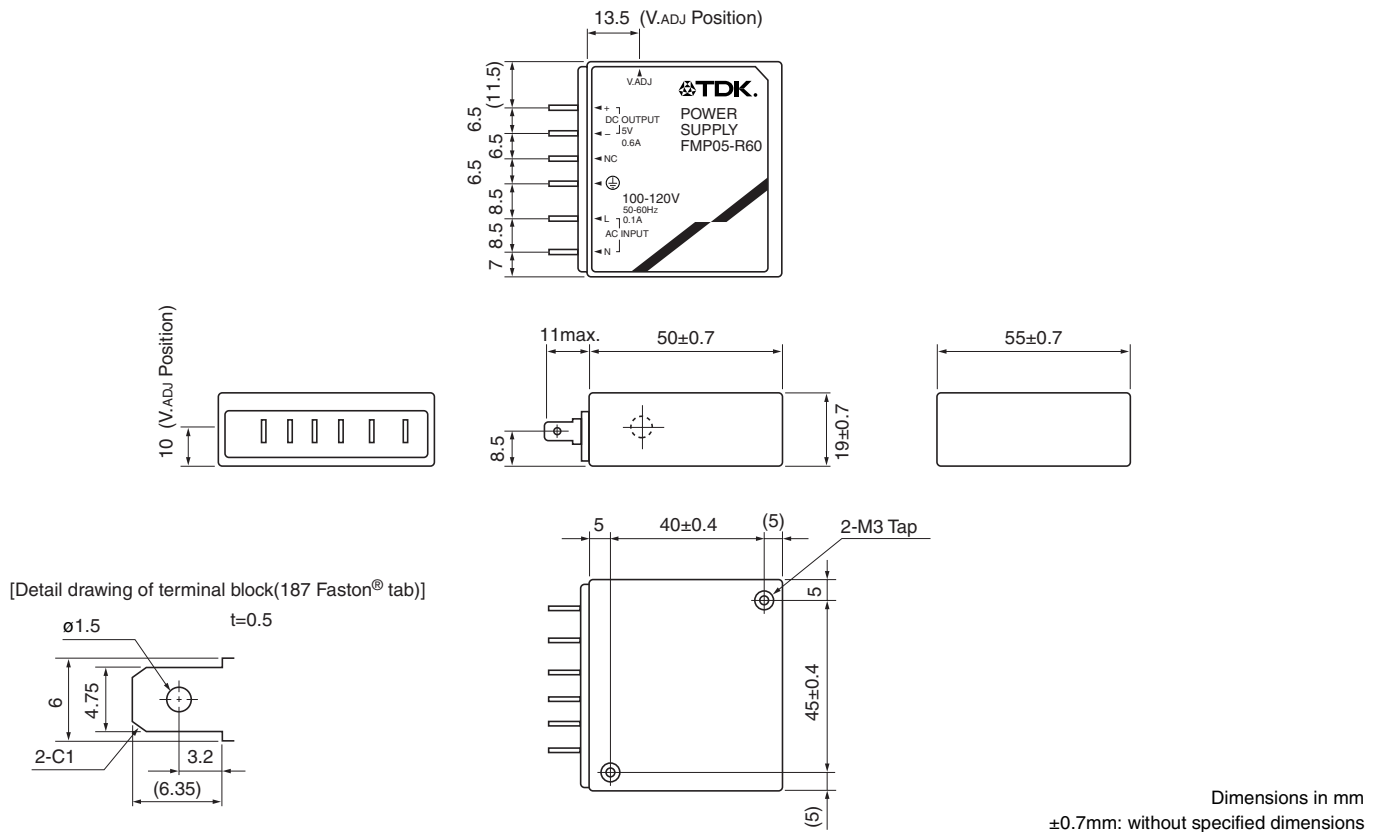

- Do not insert M3 installation screws more than 6mm into the power supply. (Recommend torque 0.48N • m)
- Faston® is registered trademark of Tyco Electronics AMP Corp. incorporated.

TERMINAL DESIGNATIONS AND FUNCTIONS

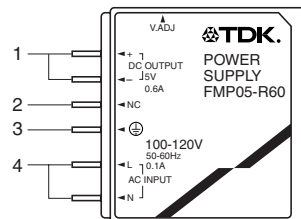

Terminal No.	Designations and functions	
1	DC output terminals(+, -)	Connect to load.
2	No connection (NC)	Connect none to this terminal.
3	Frame ground terminal(G)	Connected to ground lead for input line.
4	AC input terminals(L, N, AC INPUT)	Connect to AC.100 to 120V single phase input line.

FMP10W Type

SPECIFICATIONS AND STANDARDS

Part No.		FMP05-2R0 ^{*4}	FMP12-R85	FMP24-R45
Rated output voltage and current ^{*1}		5V • 2A	12V • 0.85A	24V • 0.45A
Maximum output power	W	10	10.2	10.8
Input conditions				
Input voltage Eac	V	85 to 132[Rating: 100 to 120]		
Input frequency	Hz	47 to 440[Rating: 50 to 60](Single phase)		
Input current	A	0.35max./0.25typ.[AC.85V]		
Surge current	A	16max.[Input and output ratings, 25°C, cold start]		
Leakage current	mA	0.5max.[Input and output ratings]		
Efficiency	%	75typ.	78typ.	81typ.
Output characteristics				
Output voltage Edc	V	5	12	24
Voltage variable range Edc	V	4.5 to 5.5	10.8 to 13.2	21.6 to 26.4
Maximum output current	A	2	0.85	0.45
Minimum output current ^{*2}	A	0.2	0.08	0.04
Overcurrent threshold	A	2.2 to 3.3	0.9 to 1.4	0.5 to 0.8
Voltage stability	Source effect	%	0.1typ.[Within the input voltage range]	
	Load effect ^{*2}	%	0.8typ.[10 to 100% load]	
	Temperature effect	%	1typ.[Ambient temperature: 0 to +50°C]	
	Drift(Time effect)	%	1max.[25°C, input and output ratings, after input voltage ON for 30min to 8h]	
	Recovery	%/ms	±4max./1max.[50 to 100% sudden load change]	
Ripple Ep-p	mV	50max.	80max.	100max.
Ripple noise Ep-p	mV	100max.	150max.	150max.
Start up time	ms	100max.		
Hold up time	ms	20min.		
Auxiliary functions				
Indicator display		No		
Overvoltage protection		Uses overvoltage prevention. ^{*3}		
Overcurrent protection		Rectangular type, automatic recovery.		
Remote ON-OFF		No		
Remote sensing		No		
Output voltage external variable function		No		
Standards				
Safety standards		—		
Noise terminal voltage		FCC class B meet.		
Constructions				
External dimensions	mm	19×55×80[H×W×L](Except input and output terminals)		
Weight	g	100max.		
Mounting method		Can be attached to 1 side.		
Case material		Nonflammable resin.		
Input and output cables		No		

^{*1} Current rating(maximum output current) is determined for 0 to +50°C. Derating is required when used outside this temperature range.

^{*2} The output load variation is determined within the range set by the minimum output current and the maximum output current. Nominal values might possibly not be satisfied when output is below the minimum output current.

^{*3} Although there is no built-in overvoltage protection circuit, the overvoltage prevention method is used for circuit design, thereby preventing overvoltage.

^{*4} Output may fail to come on when operated in series.

FMP10W Type

SHAPES AND DIMENSIONS

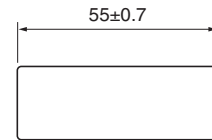
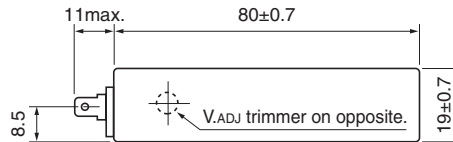
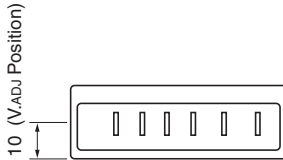
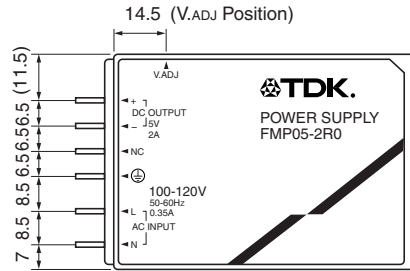

[Detail drawing of terminal block(187 Faston® tab)]

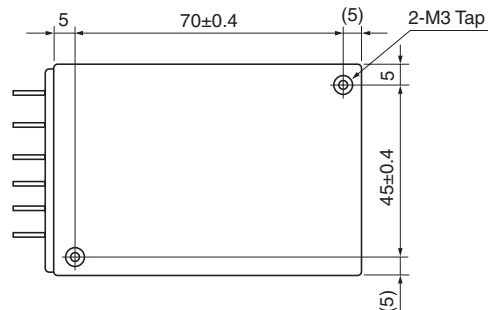
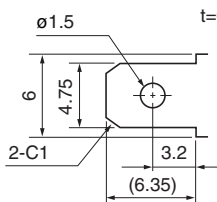

Dimensions in mm
±0.7mm : without specified dimensions

- Do not insert M3 installation screws more than 6mm into the power supply. (Recommend torque 0.48N • m)
- Faston® is registered trademark of Tyco Electronics AMP Corp. incorporated.

TERMINAL DESIGNATIONS AND FUNCTIONS

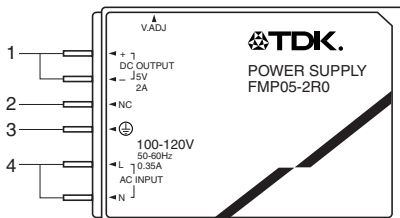

Terminal No.	Designations and functions	
1	DC output terminals(+, -)	Connect to load.
2	No connection (NC)	Connect none to this terminal.
3	Frame ground terminal(G)	Connected to ground lead for input line.
4	AC input terminals(L, N, AC INPUT)	Connect to AC.100 to 120V single phase input line.

FMP-B3W Type

SPECIFICATIONS AND STANDARDS

Part No.		FMP05-R60B*4	FMP12-R25B	FMP24-R13B
Rated output voltage and current*1		5V • 0.6A	12V • 0.25A	24V • 0.13A
Maximum output power	W	3	3	3.1
Input conditions				
Input voltage Eac	V	85 to 132[Rating: 100 to 120]		
Input frequency	Hz	47 to 440[Rating: 50 to 60](Single phase)		
Input current	A	0.1max./0.08typ.[AC.85V]		
Surge current	A	16max.[Input and output ratings, 25°C, cold start]		
Leakage current	mA	0.5max.[Input and output ratings]		
Efficiency	%	68typ.	70typ.	74typ.
Output characteristics				
Output voltage Edc	V	5	12	24
Voltage variable range Edc	V	4.5 to 5.5	10.8 to 13.2	21.6 to 26.4
Maximum output current	A	0.6	0.25	0.13
Minimum output current*2	A	0.06	0.02	0.01
Overcurrent threshold	A	0.7 to 1.2	0.3 to 0.5	0.15 to 0.3
Voltage stability	Source effect	% 0.1typ.[Within the input voltage range]		Total effect ±3max.(±1typ.)
	Load effect*2	% 0.8typ.[10 to 100% load]		
	Temperature effect	% 1typ.[Ambient temperature: 0 to +50°C]		
	Drift(Time effect)	% 1max.[25°C, input and output ratings, after input voltage ON for 30min to 8h]		
Recovery	%/ms	±4max./1max.[50 to 100% sudden load change]		
Ripple Ep-p	mV	50max.	80max.	100max.
Ripple noise Ep-p	mV	100max.	150max.	150max.
Start up time	ms	100max.		
Hold up time	ms	20min.		
Auxiliary functions				
Indicator display	No			
Overvoltage protection	Uses overvoltage prevention.*3			
Overcurrent protection	Rectangular type, automatic recovery.			
Remote ON-OFF	No			
Remote sensing	No			
Output voltage external variable function	No			
Standards				
Safety standards	—			
Noise terminal voltage	FCC class B meet.			
Constructions				
External dimensions	mm	19×55×50[H×W×L](Except input and output terminals)		
Weight	g	80max.		
Mounting method	Can be attached to 1 side.			
Case material	Nonflammable resin.			
Input and output cables	No			

*1 Current rating(maximum output current) is determined for 0 to +50°C. Derating is required when used outside this temperature range.

*2 The output load variation is determined within the range set by the minimum output current and the maximum output current. Nominal values might possibly not be satisfied when output is below the minimum output current.

*3 Although there is no built-in overvoltage protection circuit, the overvoltage prevention method is used for circuit design, thereby preventing overvoltage.

*4 Output may fail to come on when operated in series.

FMP-B3W Type

SHAPES AND DIMENSIONS

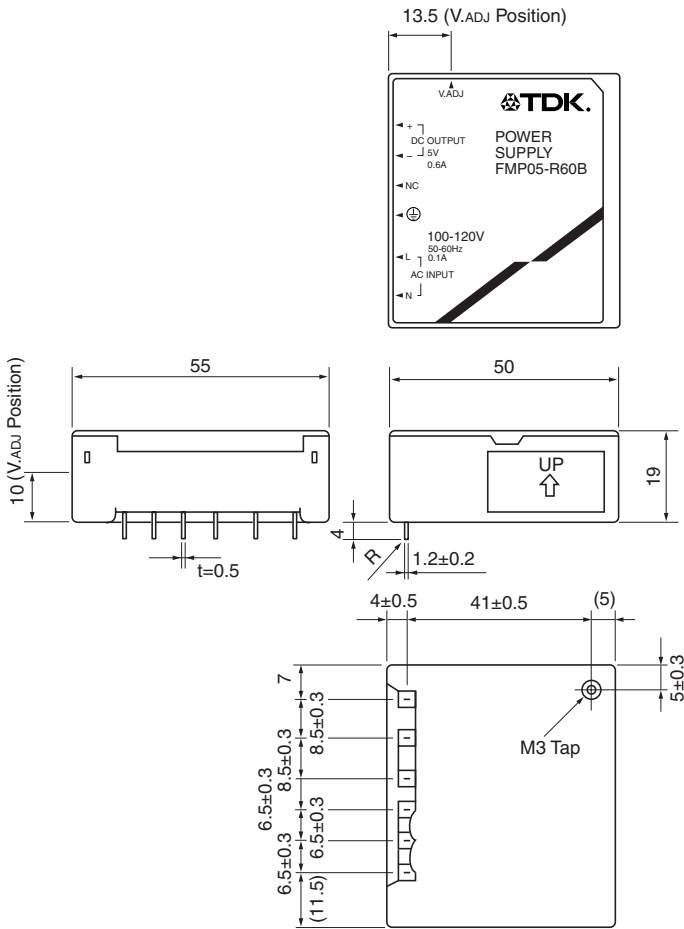

Dimensions in mm
±0.7mm : without specified dimensions

- Do not insert M3 installation screws more than 6mm into the power supply. (Recommend torque 0.48N • m)
- When mounted on PCB, must solder after insert M3.

TERMINAL DESIGNATIONS AND FUNCTIONS

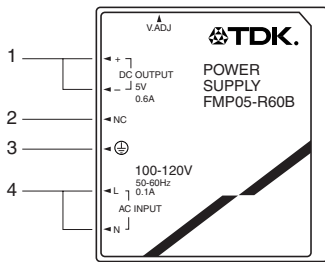

Terminal No.	Designations and functions	
1	DC output terminals(+, -)	Connect to load.
2	No connection (NC)	Connect none to this terminal.
3	Frame ground terminal(G)	Connected to ground lead for input line.
4	AC input terminals(L, N, AC INPUT)	Connect to AC.100 to 120V single phase input line.

• All specifications are subject to change without notice.

FMP-B10W Type

SPECIFICATIONS AND STANDARDS

Part No.		FMP05-2R0B*4	FMP12-R85B	FMP24-R45B
Rated output voltage and current*1		5V • 2A	12V • 0.85A	24V • 0.45A
Maximum output power	W	10	10.2	10.8
Input conditions				
Input voltage Eac	V	85 to 132[Rating: 100 to 120]		
Input frequency	Hz	47 to 440[Rating: 50 to 60](Single phase)		
Input current	A	0.35max./0.25typ.[AC.85V]		
Surge current	A	16max.[Input and output ratings, 25°C, cold start]		
Leakage current	mA	0.5max.[Input and output ratings]		
Efficiency	%	75typ.	78typ.	81typ.
Output characteristics				
Output voltage Edc	V	5	12	24
Voltage variable range Edc	V	4.5 to 5.5	10.8 to 13.2	21.6 to 26.4
Maximum output current	A	2	0.85	0.45
Minimum output current*2	A	0.2	0.08	0.04
Overcurrent threshold	A	2.2 to 3.3	0.9 to 1.4	0.5 to 0.8
Voltage stability	Source effect	%	0.1typ.[Within the input voltage range]	
	Load effect*2	%	0.8typ.[10 to 100% load]	
	Temperature effect	%	1typ.[Ambient temperature: 0 to +50°C]	
	Drift(Time effect)	%	1max.[25°C, input and output ratings, after input voltage ON for 30min to 8h]	
Recovery	%/ms	±4max./1max.[50 to 100% sudden load change]		
Ripple Ep-p	mV	50max.	80max.	100max.
Ripple noise Ep-p	mV	100max.	150max.	150max.
Start up time	ms	100max.		
Hold up time	ms	20min.		
Auxiliary functions				
Indicator display	No			
Overvoltage protection	Uses overvoltage prevention.*3			
Overcurrent protection	Rectangular type, automatic recovery.			
Remote ON-OFF	No			
Remote sensing	No			
Output voltage external variable function	No			
Standards				
Safety standards	—			
Noise terminal voltage	FCC class B meet.			
Constructions				
External dimensions	mm	19×55×80[H×W×L](Except input and output terminals)		
Weight	g	100max.		
Mounting method	Can be attached to 1 side.			
Case material	Nonflammable resin.			
Input and output cables	No			

*1 Current rating(maximum output current) is determined for 0 to +50°C. Derating is required when used outside this temperature range.

*2 The output load variation is determined within the range set by the minimum output current and the maximum output current. Nominal values might possibly not be satisfied when output is below the minimum output current.

*3 Although there is no built-in overvoltage protection circuit, the overvoltage prevention method is used for circuit design, thereby preventing overvoltage.

*4 Output may fail to come on when operated in series.

FMP-B10W Type

SHAPES AND DIMENSIONS

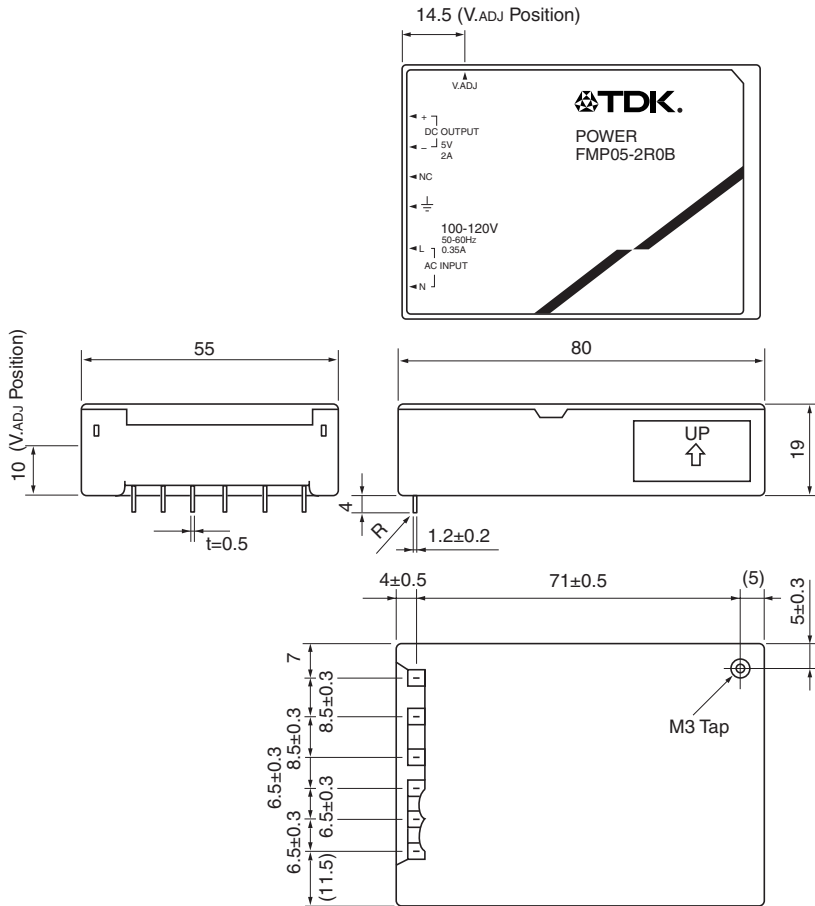

Dimensions in mm
 ± 0.7 mm: without specified dimensions

- Do not insert M3 installation screws more than 6mm into the power supply. (Recommend torque $0.48\text{N} \cdot \text{m}$)
- When mounted on PCB, must solder after insert M3.

TERMINAL DESIGNATIONS AND FUNCTIONS

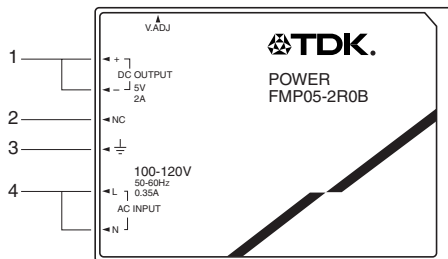

Terminal No.	Designations and functions	
1	DC output terminals(+, -)	Connect to load.
2	No connection (NC)	Connect none to this terminal.
3	Frame ground terminal(G)	Connected to ground lead for input line.
4	AC input terminals(L, N, AC INPUT)	Connect to AC.100 to 120V single phase input line.

Characteristics, Functions, and Applications

COMMON SPECIFICATIONS

Temperature and humidity		
Temperature range	Operating(°C)	0 to +60[Derating is necessary when operating environment temperature exceed 50°C.]
	Storage(°C)	-25 to +75
Humidity range	Operating(%)RH	20 to 95[Maximum wet-bulb temperature: 35°C, without dewing]
	Storage(%)RH	
Vibration and shock		
Vibration	5 to 10Hz	All amplitude 10mm[3 directions, each 1h]
	10 to 55Hz	Acceleration 19.6m/s ² (2G)[3 directions, each 1h]
Shock	Acceleration	196m/s ² (20G)[3 directions, each 3 times]
	Pulse duration	11±5ms
Withstand voltage and insulation resistance		
Withstand voltage	Input terminal to ground terminal(G)	Eac: 2kV, 1min[Normal temperature, normal humidity, cutout current 10mA]
	Input terminal to output terminal	
Insulation resistance	Input terminal to ground terminal(G)	Edc: 500V, 100MΩ min. [Normal temperature, normal humidity]
	Input terminal to output terminal	
	Output terminal to ground terminal(G)	

BLOCK DIAGRAM

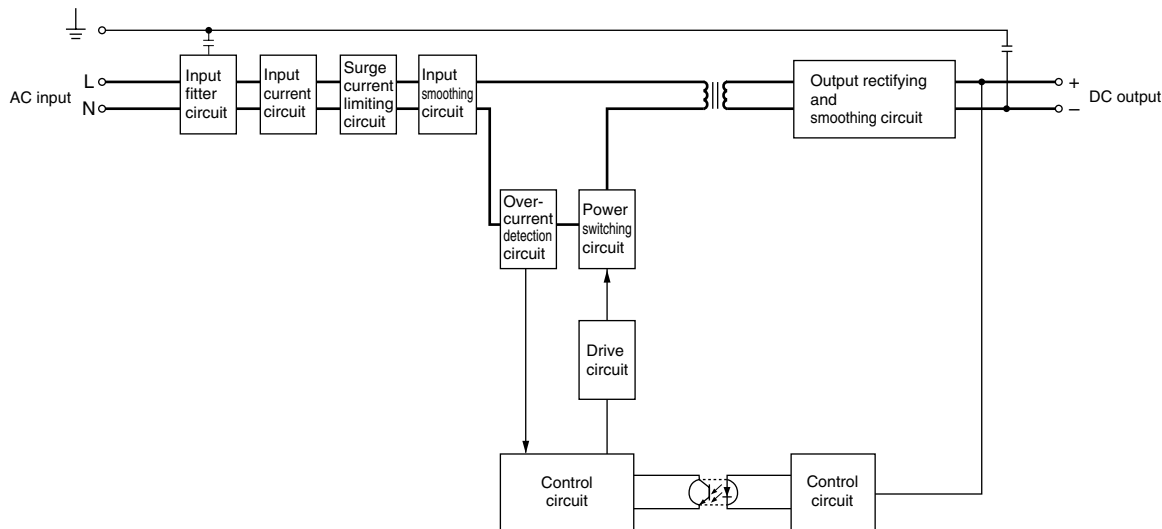

OUTPUT POWER-AMBIENT TEMPERATURE(DERATINGS)

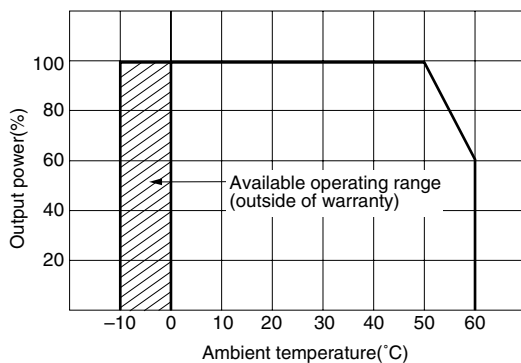

Characteristics, Functions, and Applications

START UP TIME(25°C, RATED INPUT AND OUTPUT) 3W TYPE

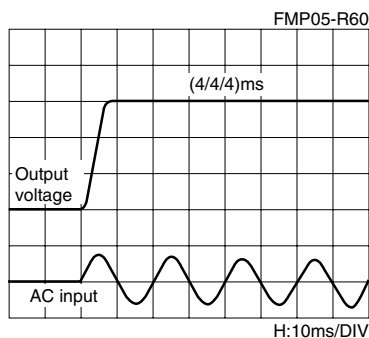

10W TYPE

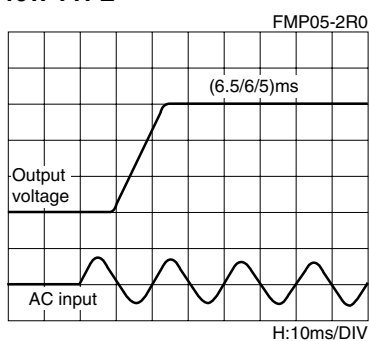

HOLD UP TIME(25°C, RATED INPUT AND OUTPUT) 3W TYPE

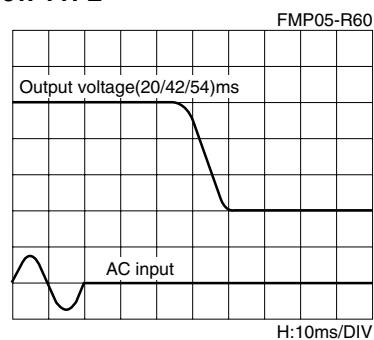

10W TYPE

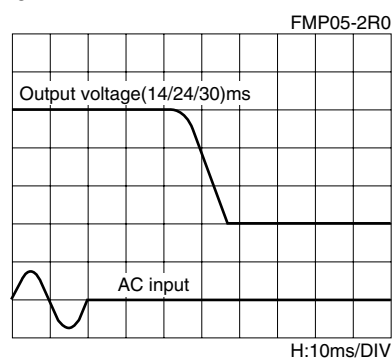

- Three numeric values in the above data indicate output voltages which may reach 90% or higher of the rated output voltage at the input voltage AC.85/100/132V.

OUTPUT VOLTAGE CHARACTERISTICS 3W TYPE

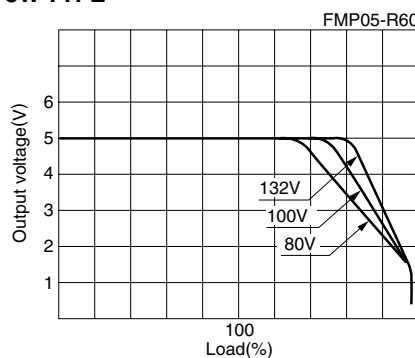

10W TYPE

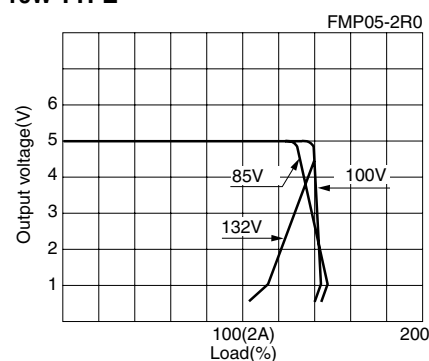

Characteristics, Functions, and Applications

INPUT/OUTPUT TERMINAL

For input/output terminals, 187-type Faston® tabs are used. These terminals are commercially available from various terminal manufacturers. Two manufacturing companies among them will be introduced below. These terminals can be soldered, though it is undesirable to heat them for a long time.

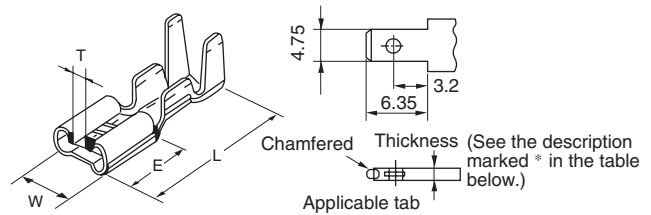

187 TAB PRODUCT INTRODUCTION A

4.8 mm series tab connection terminal (187 tab-on connector)

Unit: mm

Part No.	Applicable wires	External diameter of insulated coating(mm)	Material	Surface treatment	W	L	E	T (approx.)	Plate thickness	Thickness of applicable tab*	Quantity/reel
STO-01-187N	FS4.8B-0.5-5(STO-01T-187N)*1*2	0.2 to 0.5	Brass	—	5.6	15	6.3	1.5	0.32	0.5	10,000
Tinning											
STO-41-187N*2	FS4.8B-1.25-5(STO-41-187N)*1*2	0.5 to 1.25	Brass	—	5.6	15	6.3	1.5	0.32	0.5	10,000
Tinning											

*1 JIS standard product (JIS C2809). The number in parentheses () indicates a conventional part number.

*2 UL registered product.

• This data is cited from the catalog No. TER-017A-14P (P. 8) of Japan Pressure Terminal Sales Co., Ltd., titled "Continuous Pressure Terminal and Connector."

187 TAB PRODUCT INTRODUCTION B

187 series receptacle

Unit: mm

Range of applicable wires		External diameter of coating	Thickness of tab in the other side	Plate thickness	Size		Material and finishing	Part No. of receptacle		Quantity per reel
AWG	(mm ²)				L	T		In chain	In loose	
24-20	0.2 to 0.56	1.02 to 1.78	0.51	0.3	15	1.5	Brass	60573-2	60711-2*	20
		1.5 to 2.5	0.5	0.32			Brass and tin	60573-1	60711-1*	
							Copper and nickel	60621-1	61020-1*	
20-16	0.5 to 1.42	2.29 to 3.3	0.51	0.32	15.2	1.5	Brass	170037-1	170038-1	9
							Brass and tin	170037-2	170038-2	
							Phosphor bronze and tin	170037-4	170038-4	
18-16 or 18×2	0.75 to 1.42 (0.75 to 0.89)×2	2.67×2 max.	0.51	0.3	15	1	Brass and tin	60487-2	—	20
18-14	0.75 to 2.27	2.2 to 3.4	0.51	0.3	15.2	1.5	Phosphor bronze and tin	170466-1	170467-1	9

* No preform of a wire barrel.

• This data is cited from the catalog No. F.FF-21 (P. 20) of Tyco Electronics AMP Corp. titled "Faston® Connector and Fastine Faston® Connector."

INPUT FUSE

These products have no embedded F series, FMP, and input fuse. To further improve safety of an FMP-embedded device, it is recommended to mount a fuse on an AC input terminal (L side).

Ratings of recommended external fuse

FMP3W: 0.63A

FMP10W: 1A

OTHER CONDITIONS

- Unless conditions are otherwise specified in the specifications or standards, 25°C and rated input-output should be applied.
- Ripple and noise (50MHz max.) were determined for 0 to +50°C temperature range and 10 to 100% load.

• Faston® and Fastine Faston® is registered trademark of Tyco Electronics AMP Corp. Incorporated.

• All specifications are subject to change without notice.