

NOTES

A : M4 TAPPED HOLES
10 POINTS FOR CUSTOMER CHASSIS MOUNTING.
SCREWS MUST NOT BE PROTRUDE INTO POWER SUPPLY BY 7mm.

B : MODEL NAME, INPUT VOLTAGE RANGE, NOMINAL OUTPUT VOLTAGE,
MAXIMUM OUTPUT CURRENT, COUNTRY OF MANUFACTURE
AND SAFETY MARKING (FOR ONLY APPROVED PRODUCTS) ARE
SHOWN HERE IN ACCORDANCE WITH THE SPECIFICATIONS.

C : \perp IS PROTECTIVE BONDING TERMINAL.

TOLERANCE : ±1mm UNLESS OTHERWISE SPECIFIED.

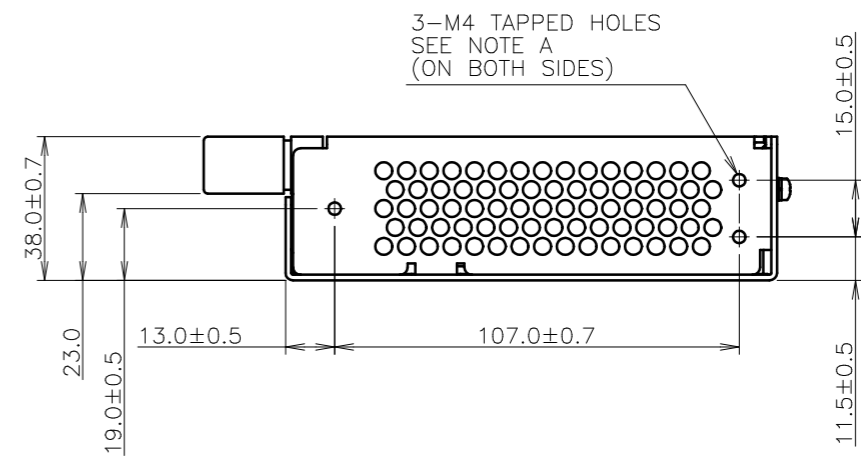

(unit : mm)

MODEL NAME	RDS30A-24
TDK-Lambda	

FA005-02-01A