

PAH350S48-*

EVALUATION DATA

型式データ

DWG.NO. C174-53-01/350			
承認	承認	査閲	担当
<i>S. Murayama</i>	<i>S. Tomioka</i>	<i>T. Udagawa</i>	<i>Y. Watanabe</i>
28. Aug. '03	28. Aug. '03	22. Aug. '03	27. Aug. '03

DENSEI-LAMBDA

INDEX

1. 測定方法	Evaluation Method	PAGE
1.1	測定回路 Circuits used for determination	T-1~5
	(1) 静特性 Steady state data	
	(2) 通電ドリフト特性 Warm up voltage drift characteristics	
	(3) 過電流保護特性 Over current protection (OCP) characteristics	
	(4) 過電圧保護特性 Over voltage protection (OVP) characteristics	
	(5) 出力立ち上がり特性 Output rise characteristics	
	(6) 出力立ち下がり特性 Output fall characteristics	
	(7) 出力立ち上がり特性 (ON/OFFコントロール時) Output rise characteristics with ON/OFF CONTROL	
	(8) 出力立ち下がり特性 (ON/OFFコントロール時) Output fall characteristics with ON/OFF CONTROL	
	(9) 過渡応答(負荷急変)特性 Dynamic load response characteristics	
	(10) 入力リージ電流(突入電流)特性 Inrush current characteristics	
	(11) 出力リップル、ノイズ波形 Output ripple and noise waveform	
	(12) EMI特性 Electro-Magnetic Interference characteristics	
1.2	使用測定機器 List of equipments used	T-6
2.	特性データ Characteristics	
2.1	静特性 Steady state data	
	(1) 入力・負荷・温度変動 Regulation - line and load, temperature drift	T-7
	(2) 出力電圧・リップル電圧対入力電圧 Output voltage and ripple voltage v.s. input voltage	T-8
	(3) 効率・入力電流対出力電流 Efficiency and input current v.s. output current	T-9
	(4) 効率対入力電圧 Efficiency v.s. input voltage	T-10
	(5) 効率対ベースプレート温度 Efficiency v.s. baseplate temperature	T-11
2.2	通電ドリフト特性 Warm up voltage drift characteristics	T-12
2.3	過電流保護特性 Over current protection (OCP) characteristics	T-13~14
2.4	過電圧保護特性 Over voltage protection (OVP) characteristics	T-15
2.5	出力立ち上がり特性 Output rise characteristics	T-16~17
2.6	出力立ち下がり特性 Output fall characteristics	T-18~19
2.7	出力立ち上がり特性 (ON/OFFコントロール時) Output rise characteristics with ON/OFF CONTROL	T-20~21
2.8	出力立ち下がり特性 (ON/OFFコントロール時) Output fall characteristics with ON/OFF CONTROL	T-22~23

2.9	過渡応答（負荷急変）特性	Dynamic load response characteristics	T-24
2.10	入力サージ電流（突入電流）特性	Inrush current waveform	T 25
2.11	出力リップル、ノイズ波形	Output ripple and noise waveform	T-26~27
2.12	EMI特性	Electro-Magnetic Interference characteristics		
	VCCI class A 対応アプリケーションシステム			
	VCCI class A application system		T-28~30

使用記号 Terminology used

	Definition	
Vin 入力電圧	Input Voltage
Vout 出力電圧	Output Voltage
Vcnt CNT電圧	CNT Voltage
Iin 入力電流	Input Current
Iout 出力電流	Output Current
Tbp ベースプレート温度	Baseplate Temperature

1. 測定方法 Evaluation Method

1.1 測定回路 Circuits used for determination

(1) 静特性 Steady state data

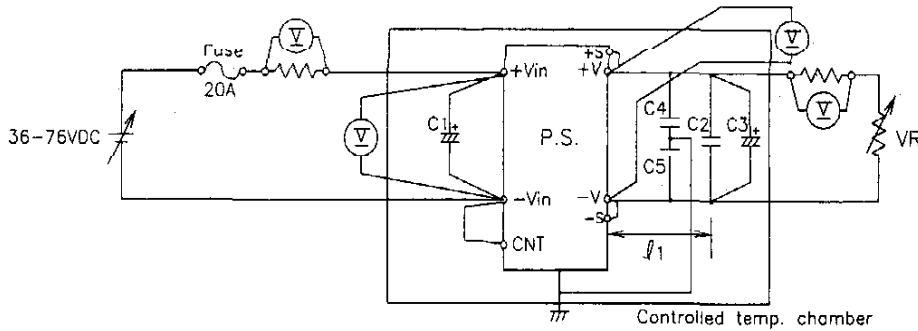

- | | | |
|---------------------------------|--------------------------------------|----------|
| C1: 33uF Electrolytic Capacitor | C3: 12V-470uF Electrolytic Capacitor | φ1: 50mm |
| C2: 0.1uF Ceramic Capacitor | 28V-220uF Electrolytic Capacitor | |
| C4,C5: 0.022uF Film Capacitor | | |

(2) 通電ドリフト特性 Warm up voltage drift characteristics

静特性と同じ

Same as Steady state data

(3) 過電流保護特性 Over current protection (OCP) characteristics

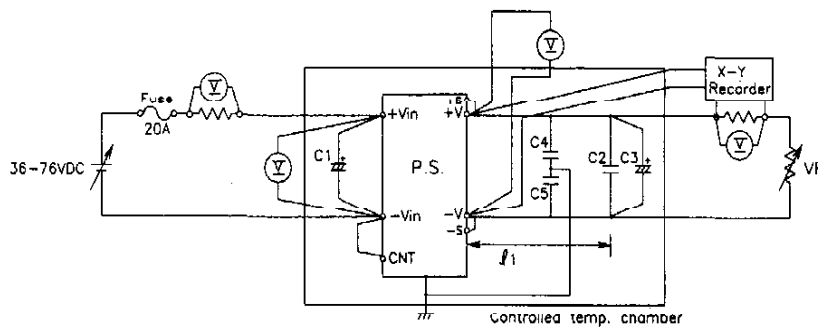

- | | | |
|---------------------------------|--------------------------------------|----------|
| C1: 33uF Electrolytic Capacitor | C3: 12V-470uF Electrolytic Capacitor | φ1: 50mm |
| C2: 0.1uF Ceramic Capacitor | 28V-220uF Electrolytic Capacitor | |
| C4,C5: 0.022uF Film Capacitor | | |

(4) 過電圧保護特性 Over voltage protection (OVP) characteristics

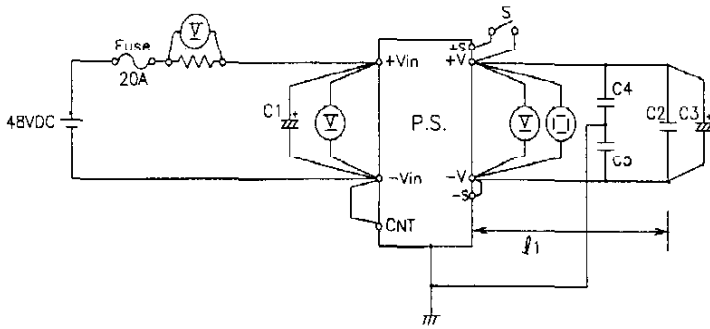

C1: 33uF Electrolytic Capacitor
 C2: 0.1uF Ceramic Capacitor
 C3: 12V-470uF Electrolytic Capacitor
 C4,C5: 0.022uF Film Capacitor
 l_1 : 50mm

(5) 出力立ち上がり特性 Output rise characteristics

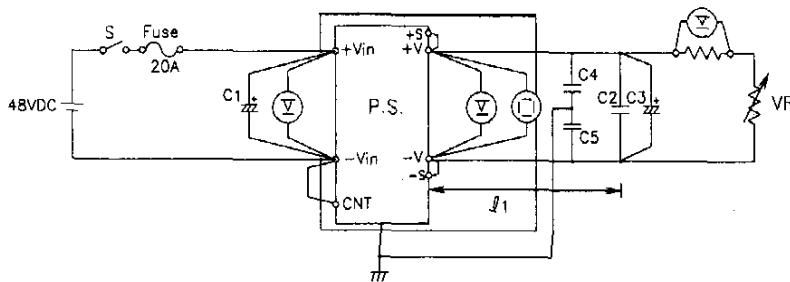

C1: 33uF Electrolytic Capacitor
 C2: 0.1uF Ceramic Capacitor
 C3: 12V-470uF Electrolytic Capacitor
 C4,C5: 0.022uF Film Capacitor
 l_1 : 50mm

(6) 出力立ち下がり Output fall characteristics

出力立ち上がり特性と同じ
 Same as output rise characteristics

(7) 出力立ち上がり特性 (ON/OFFコントロール時)

Output rise characteristics with ON/OFF CONTROL

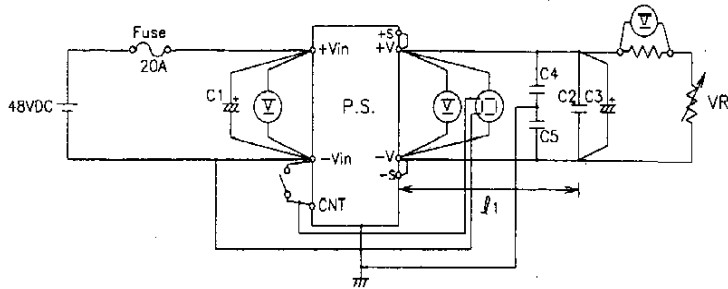

- C1: 33uF Electrolytic Capacitor
 C2: 0.1uF Ceramic Capacitor
 C3: 12V-470uF Electrolytic Capacitor
 C4,C5: 0.022uF Film Capacitor
 I1: 50mm

(8) 出力立ち下がり特性 (ON/OFFコントロール時)

Output fall characteristics with ON/OFF CONTROL

出力立ち上がり特性 (ON/OFFコントロール時) と同じ

Same as output rise characteristics with CONTROL ON/OFF

(9) 過渡応答(負荷急変)特性 Dynamic load response characteristics

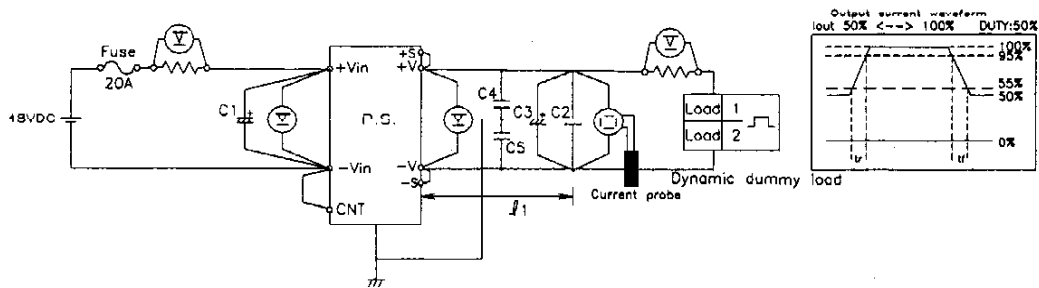

- C1: 33uF Electrolytic Capacitor
 C2: 0.1uF Ceramic Capacitor
 C3: 12V-470uF Electrolytic Capacitor
 C4,C5: 0.022uF Film Capacitor
 I1: 50mm

(10) 入力サージ電流 (突入電流) 特性 Inrush current characteristics

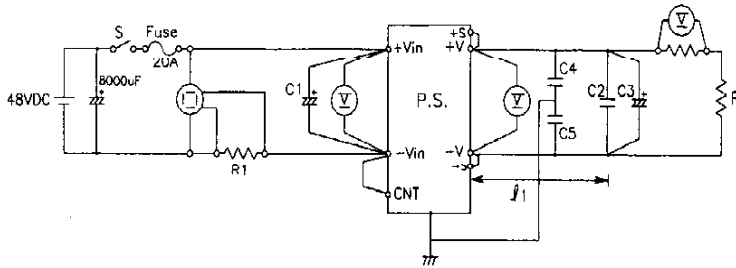

- | | | |
|---------------------------------|--------------------------------------|-----------|
| C1: 33uF Electrolytic Capacitor | C3: 12V-470uF Electrolytic Capacitor | J1: 50mm |
| C2: 0.1uF Ceramic Capacitor | 28V-220uF Electrolytic Capacitor | R1: 0.01Ω |
| | C4,C5: 0.022uF Film Capacitor | |

(11) 出力リップル、ノイズ波形 Output ripple and noise waveform

(a) Normal Mode

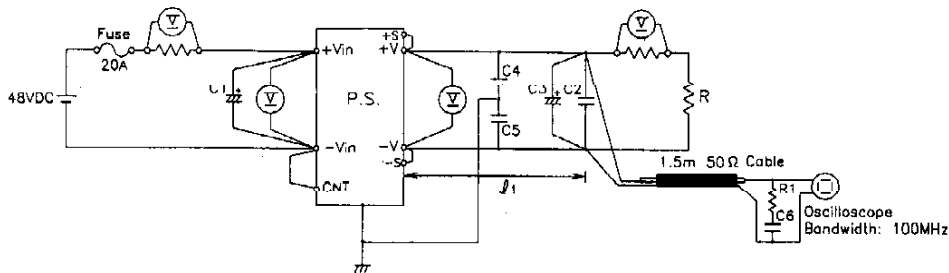

- | | | |
|---------------------------------|--------------------------------------|------------------------------|
| C1: 33uF Electrolytic Capacitor | C3: 12V-470uF Electrolytic Capacitor | C6: 4700pF Ceramic Capacitor |
| C2: 0.1uF Ceramic Capacitor | 28V-220uF Electrolytic Capacitor | R1: 50 Ω |
| | C4,C5: 0.022uF Film Capacitor | J1: 50mm |

(b) Normal + Common Mode

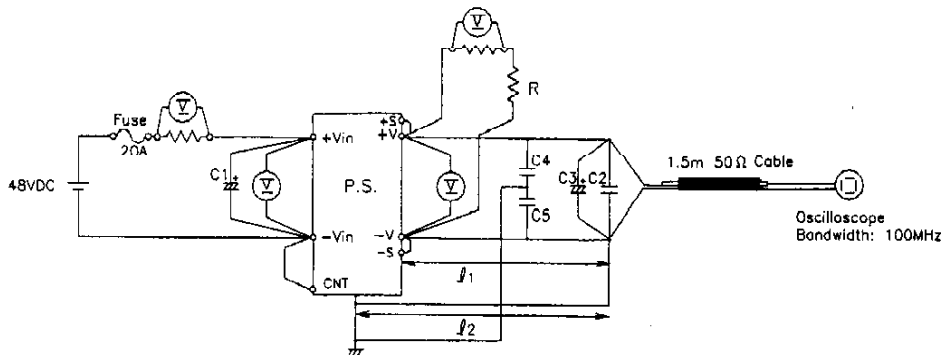

- | | | |
|---------------------------------|--------------------------------------|----------|
| C1: 33uF Electrolytic Capacitor | C3: 12V-470uF Electrolytic Capacitor | J1: 50mm |
| C2: 0.1uF Ceramic Capacitor | 28V-220uF Electrolytic Capacitor | |
| | C4,C5: 0.022uF Film Capacitor | |

(12) EMI 特性 Electro-Magnetic Interference characteristics

(a) 雑音端子電圧 (帰還ノイズ) Conducted Emission Noise

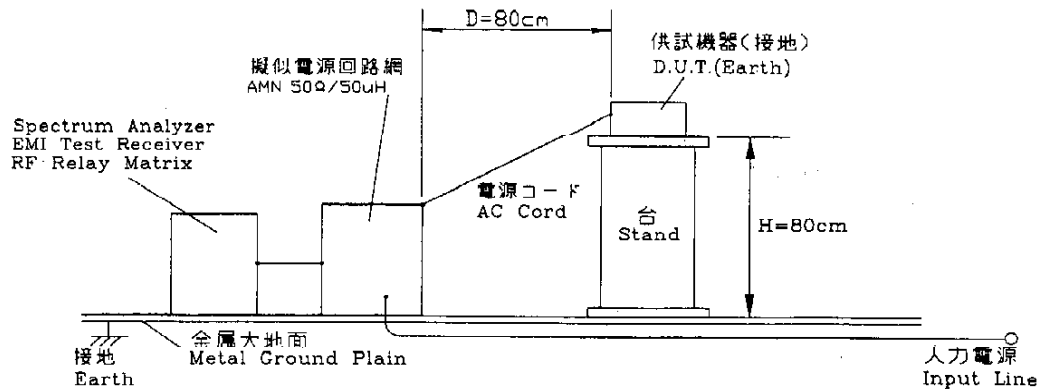

(b) 雑音電界強度 (輻射ノイズ) Radiated Emission Noise

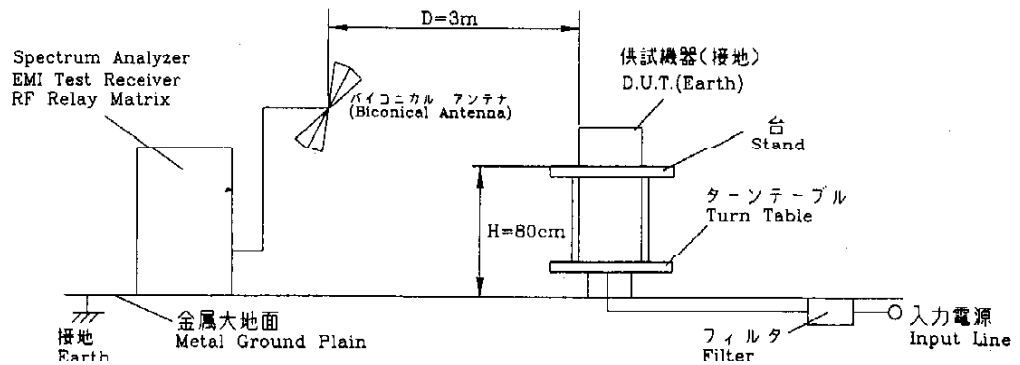

(1) VCC class A 対応対応アプリケーションシステム

VCCI class A application system

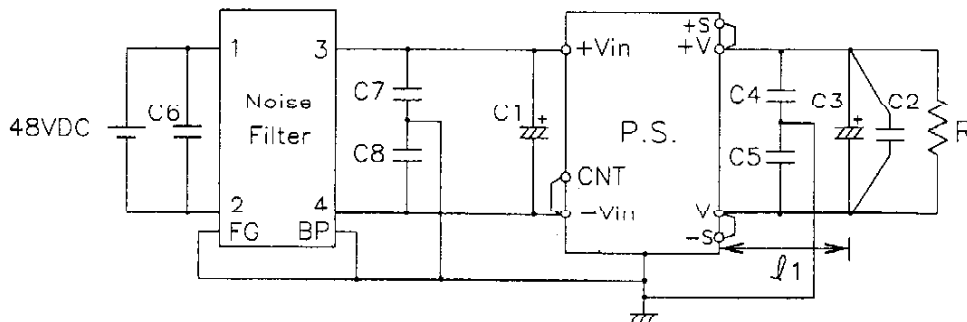

- Noise Filter : PAN4820(DENSEI-LAMBDA)
- C1 : 470uF Electrolytic Capacitor x 3para
- C2 : 0.1uF Ceramic Capacitor
- C3 : 12V-470uF Electrolytic Capacitor
- 28V-220uF Electrolytic Capacitor
- C4,C5 : 0.022uF Film Capacitor
- C6 : 1uF Ceramic Capacitor x 5para
- C7,C8 : 0.33uF Film Capacitor x 2para
- l1 : 50mm

1.2 使用測定機器 List of equipment used

	EQUIPMENT USED	MANUFACTURER	MODEL NO.
1	OSCILLOSCOPE	HITACHI DENSHI	V-1100A
2	DIGITAL STORAGE OSCILLOSCOPE	IWATSU	LT364L
3	DIGITAL MULTIMETER	ADVANTEST	R6441A
4	DIGITAL POWER METER	YOKOGAWA ELECT.	WT110
5	CURRENT PROBE/AMPLIFIER	TEKTRONIX	A6303/TM501
6	SHUNT RESISTER	YOKOGAWA ELECT.	2215
7	X-Y RECORDER	GRAPHTEC	WX3000
8	CONTROLLED TEMP. CHAMBER	TABAI ESPEC	SH-240
9	SPECTRUM ANALYZER	ROHDE & SCHWARZ	FSA
10	EMI TEST RECEIVER	ROHDE & SCHWARZ	ESHS10
11	EMI TEST RECEIVER	ROHDE & SCHWARZ	ESVS10
12	RF RELAY MATRIX	ROHDE & SCHWARZ	PSU
13	AMN	KYORITU DENSHI	KNW-242
14	ANTENNA(BICONICAL ANTENNA)	SCHWARZBECK	BBA9106
15	DYNAMIC DUMMY LOAD	TAKASAGO	FK-10001.
16	DUMMY LOAD	TOKYO SEIDEN	SC-10
17	DC POWER SUPPLY	TAKASAGO	AA2000XG

2. 特性データ Characteristics

2.1 静特性 Steady state data

(1) 入力、負荷、温度変動 Regulation - line and load, temperature drift

12V

1. Regulation - line and load

condition Tbp : 25°C

Iout \ Vin	36VDC	48VDC	76VDC	line regulation	
0%	11.973V	11.973V	11.973V	1mV	0.004%
50%	11.972V	11.972V	11.972V	0mV	0.002%
100%	11.972V	11.972V	11.971V	1mV	0.005%
load	1mV	1mV	1mV		
regulation	0.012%	0.009%	0.012%		

2. Temperature drift

conditions Vin : 48VDC

Iout : 100%

Tbp	-40°C	25°C	100°C	temperature stability	
Vout	11.974V	11.972V	11.938V	36mV	0.301%

28V

1. Regulation - line and load

condition Tbp : 25°C

Iout \ Vin	36VDC	48VDC	76VDC	line regulation	
0%	28.024V	28.022V	28.016V	8mV	0.029%
50%	28.023V	28.023V	28.018V	5mV	0.018%
100%	28.030V	28.024V	28.026V	6mV	0.021%
load	7mV	2mV	10mV		
regulation	0.025%	0.007%	0.036%		

2. Temperature drift

conditions Vin : 48VDC

Iout : 100%

Tbp	-40°C	25°C	100°C	temperature stability	
Vout	28.172V	28.024V	27.934V	238mV	0.850%

2.1 (2) 出力電圧、リップル電圧対入力電圧
Output voltage and ripple voltage v.s. input voltage

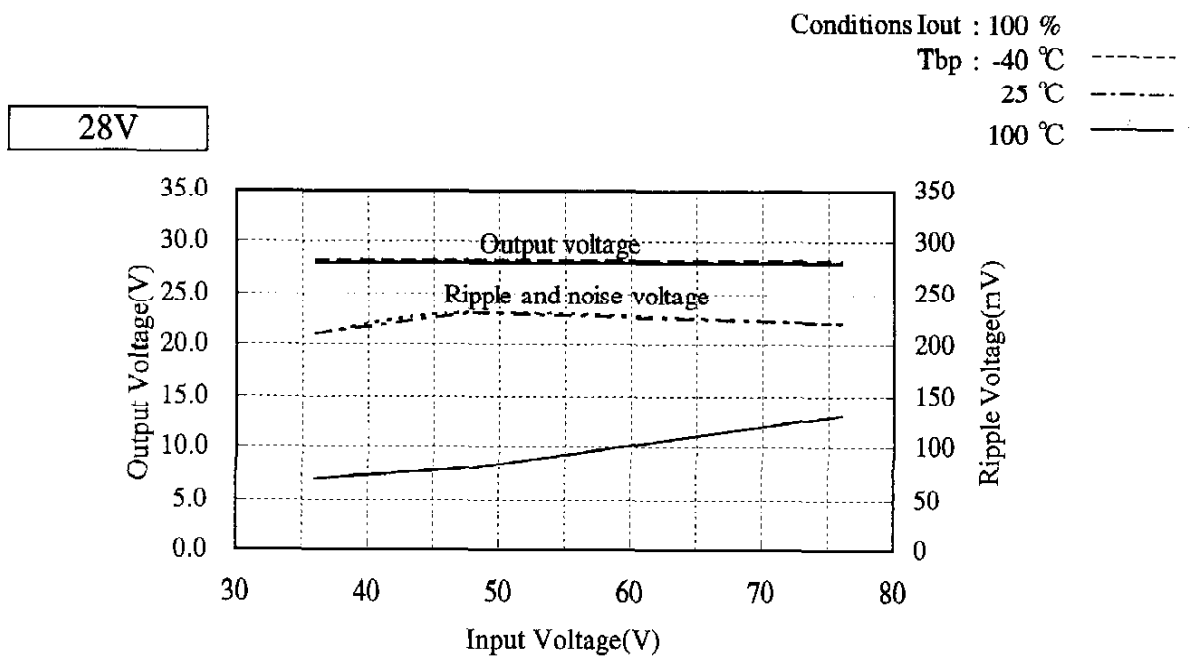
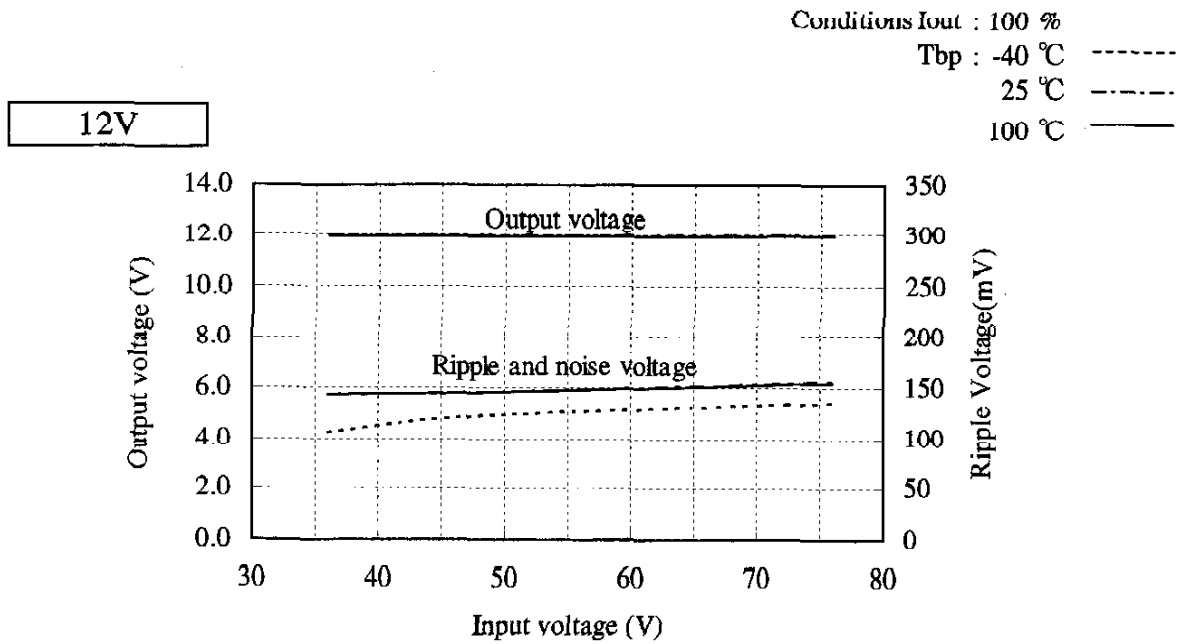

2.1 (3) 効率、入力電流対出力電流
Efficiency and input current v.s. output current

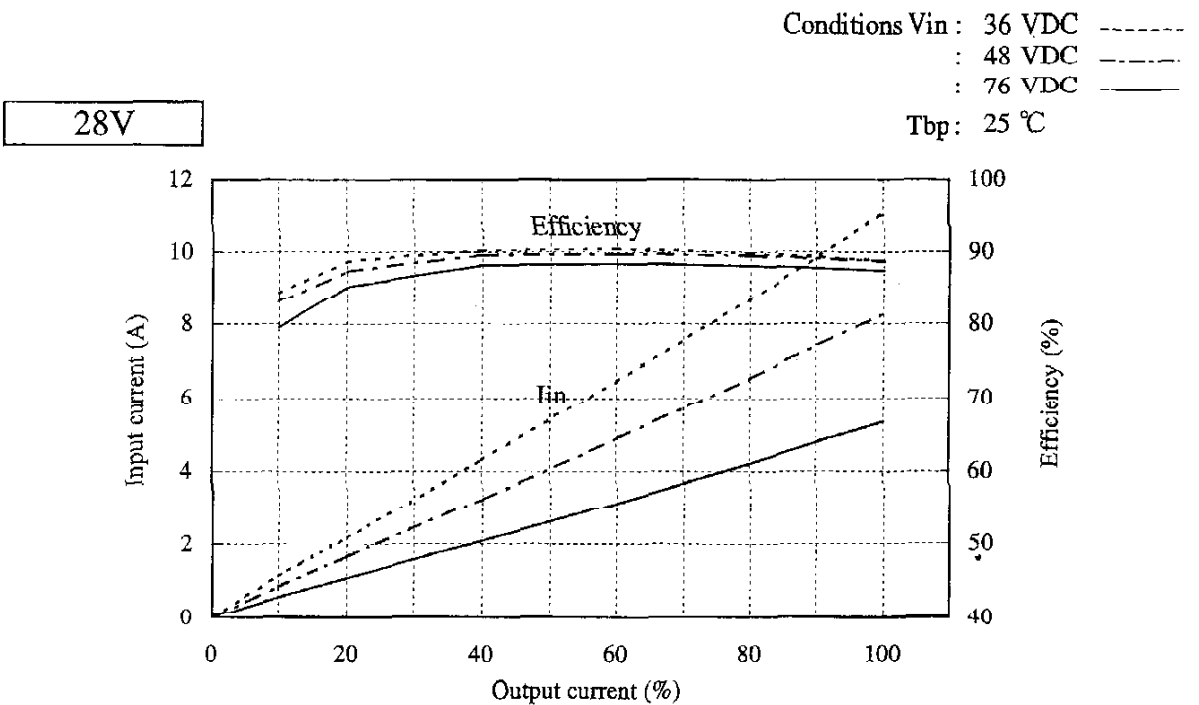
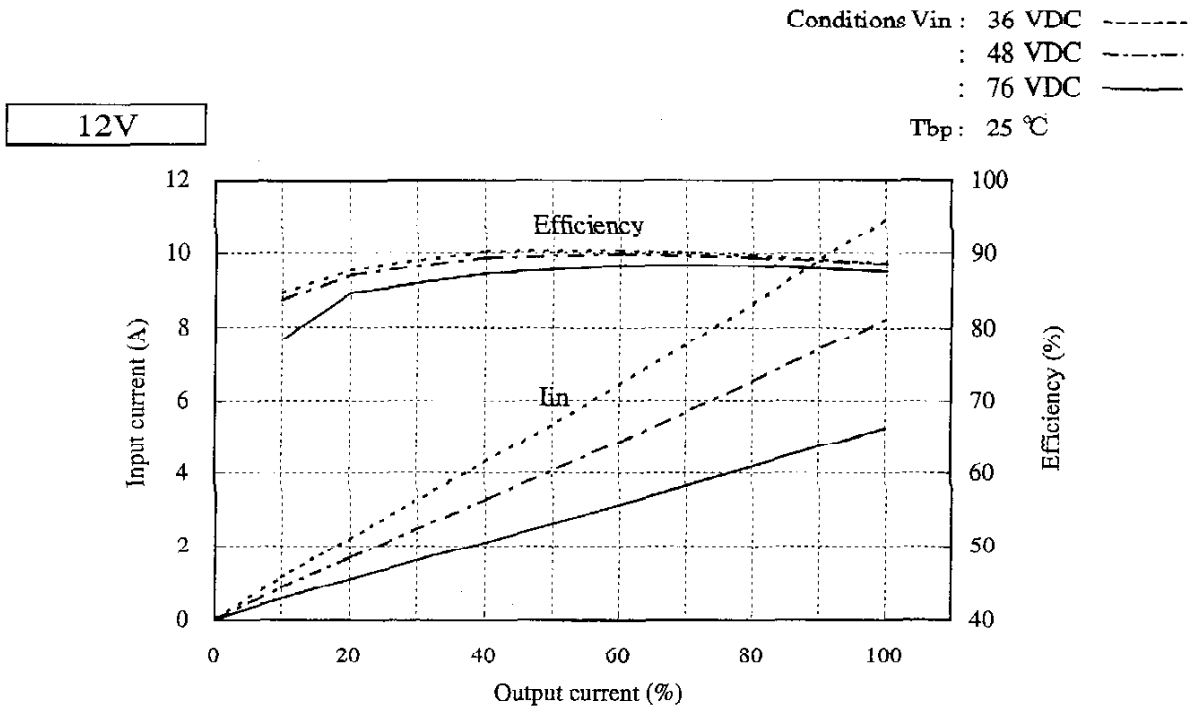

2.1 (4) 効率対入力電圧
Efficiency v.s. input voltage

Conditions Tbp : 25 °C
Iout : 50 % -----
80 % - - - - -
100 % _____

12V

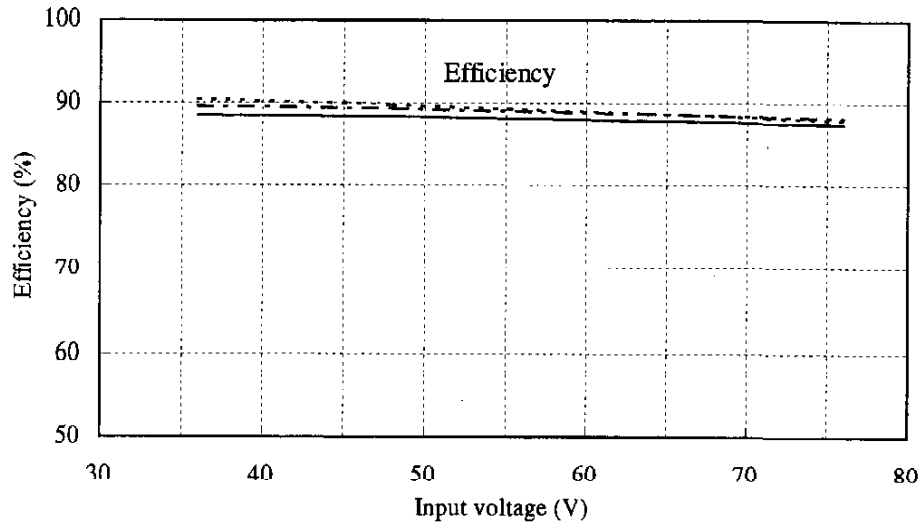

Conditions Tbp : 25 °C
Iout : 50 % -----
80 % - - - - -
100 % _____

28V

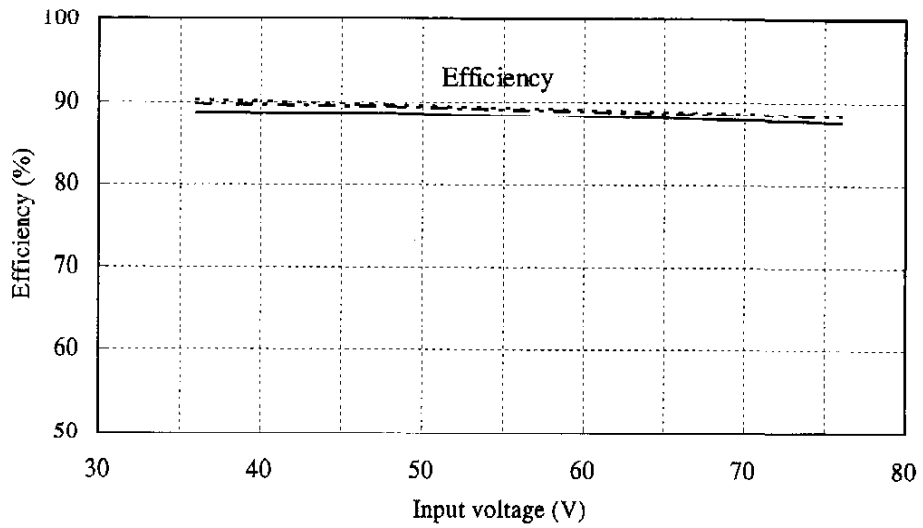

2.1 (b) 効率対ベースプレート温度
Efficiency v.s. Baseplate temperature

Conditions Vin : 48 VDC
Iout : 100 %

12V

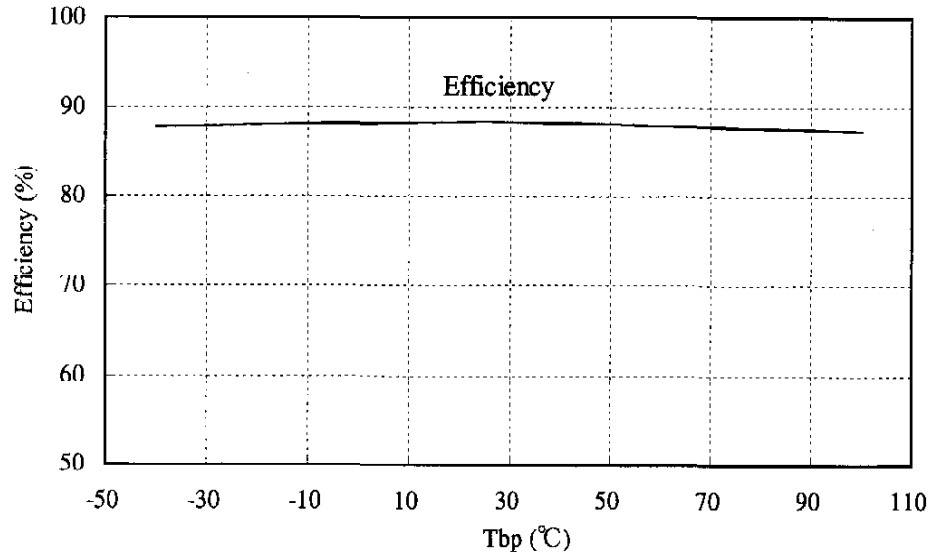

28V

Conditions Vin : 48 VDC
Iout : 100 %

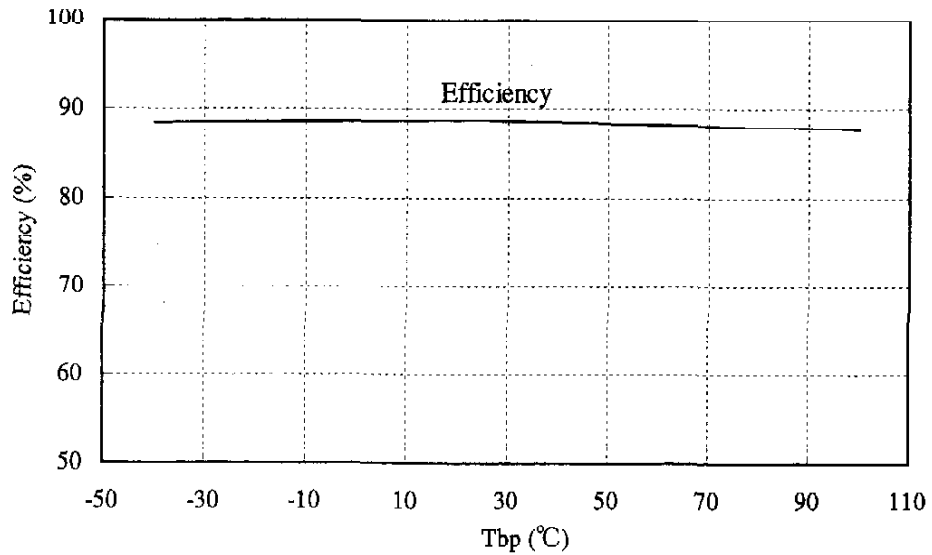

2.2 通電ドリフト特性
Warm up voltage drift characteristics

Conditions Vin : 48 VDC
Iout : 100 %
Ta : 25 °C

12V

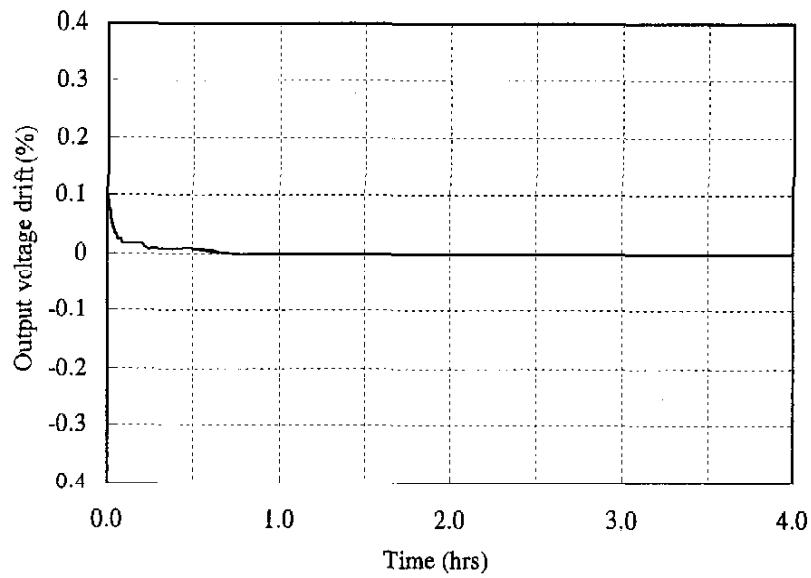

28V

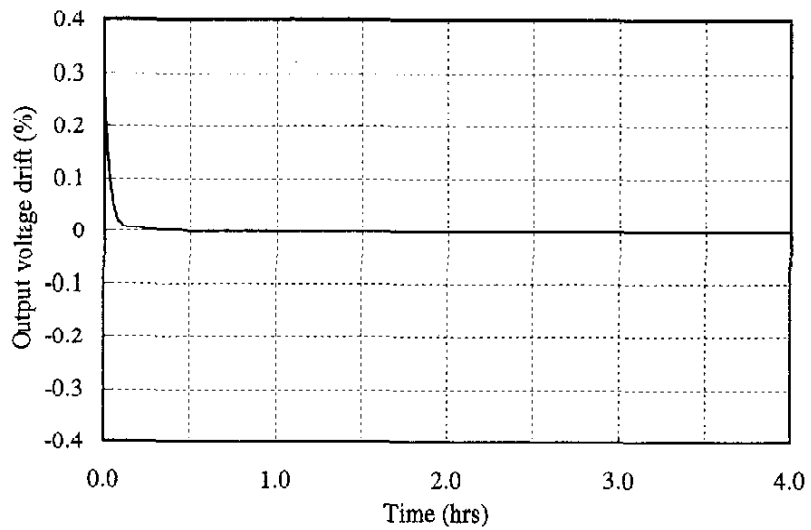

2.3 過電流保護特性
Over current protection (OCP) characteristics

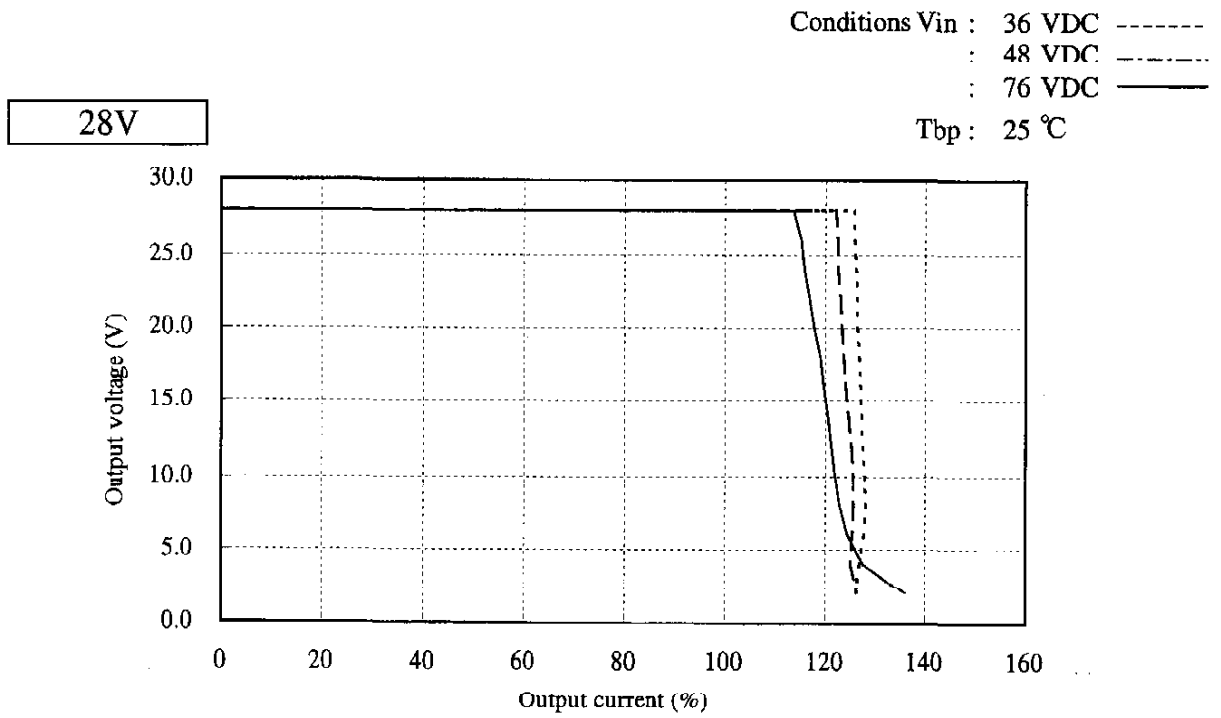
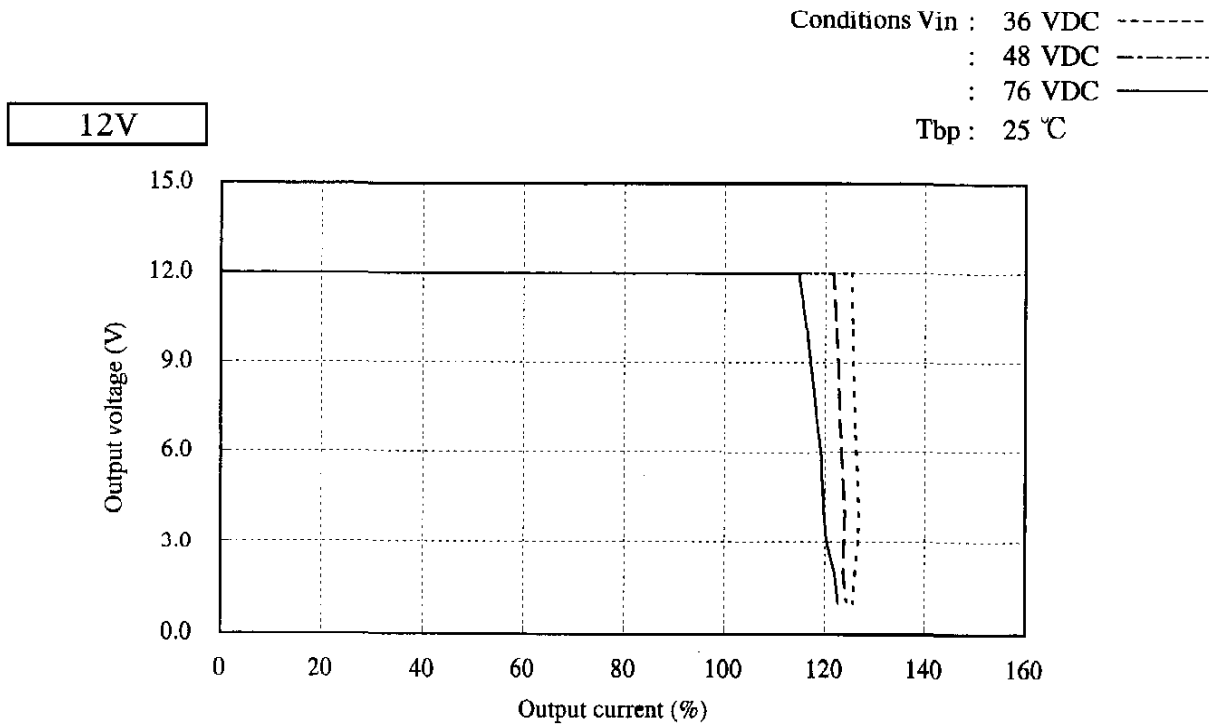

2.3 過電流保護特性
Over current protection (OCP) characteristics

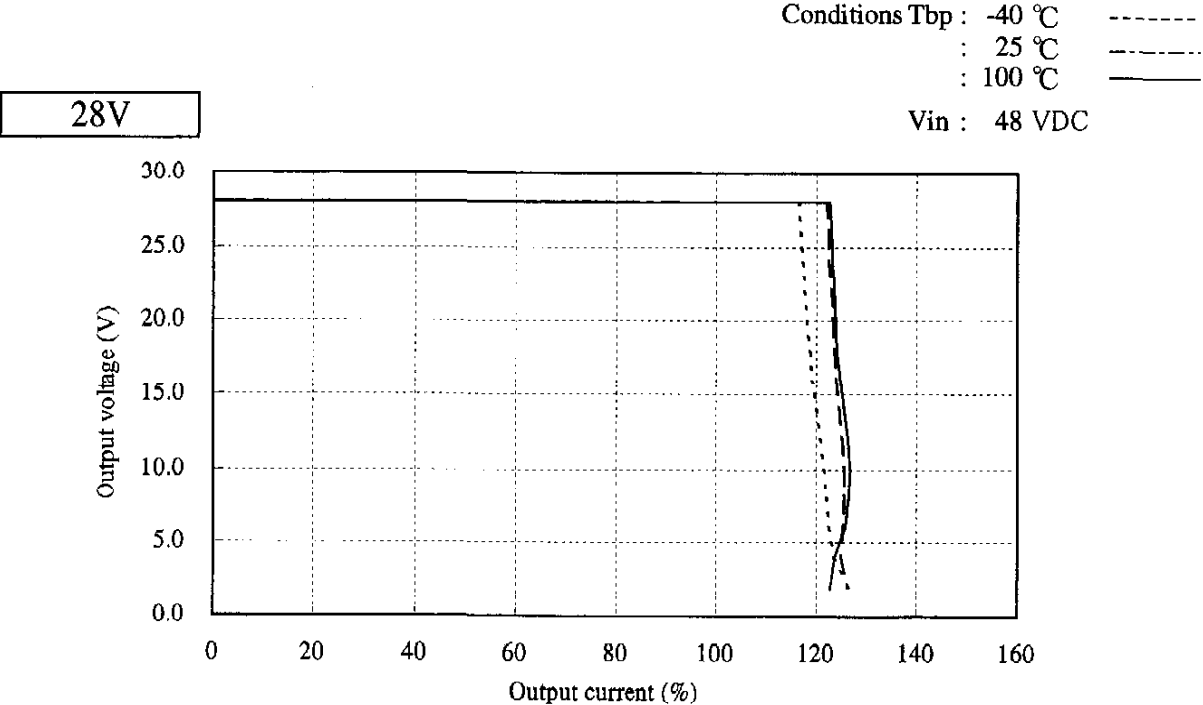
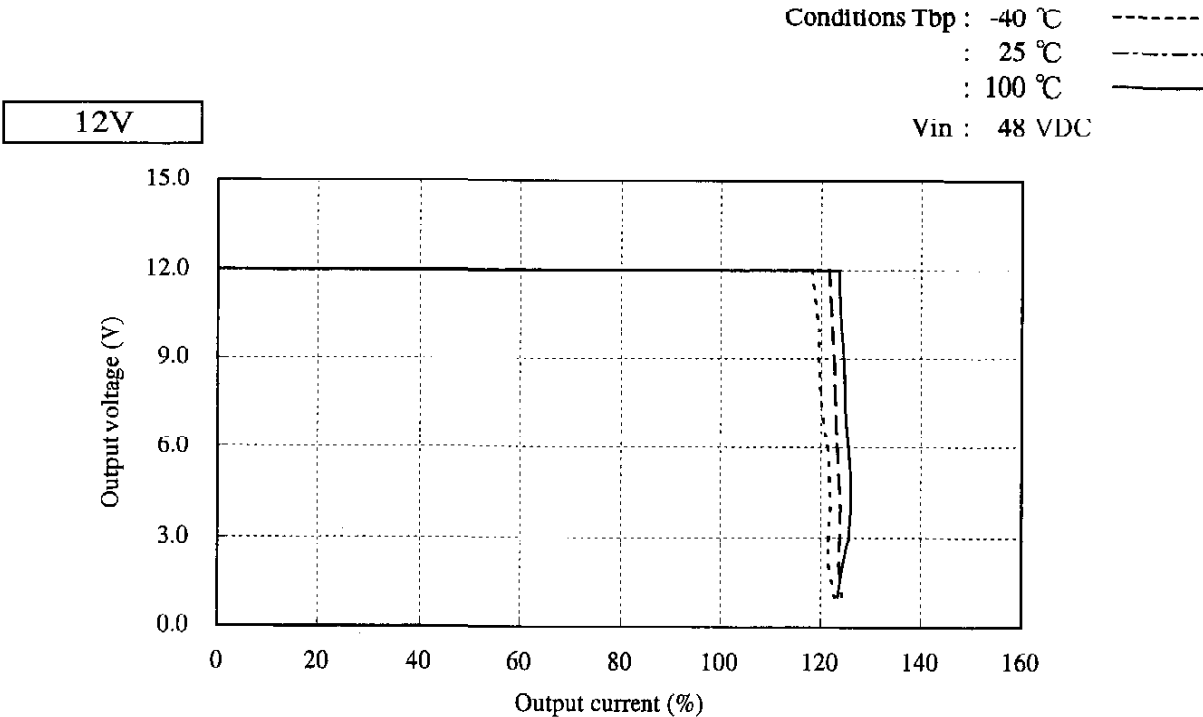

2.4 過電圧保護特性
Over voltage protection (OVP) characteristics

Conditions Vin : 48 VDC
Iout : 0 %
Tbp : 25 °C

12V

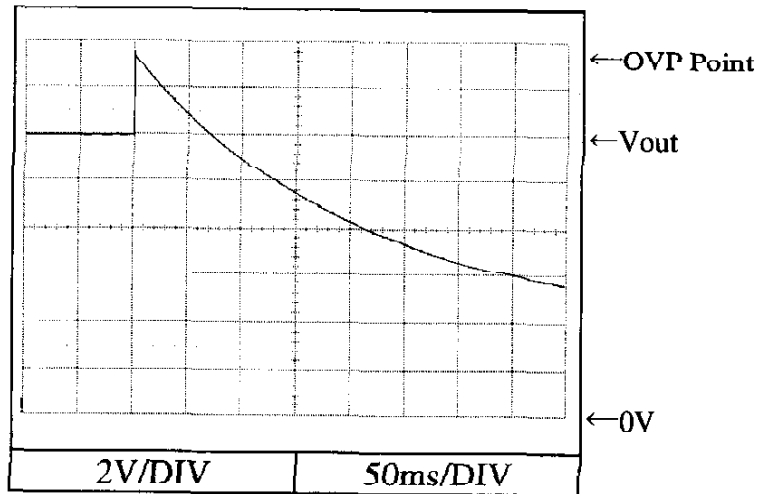

28V

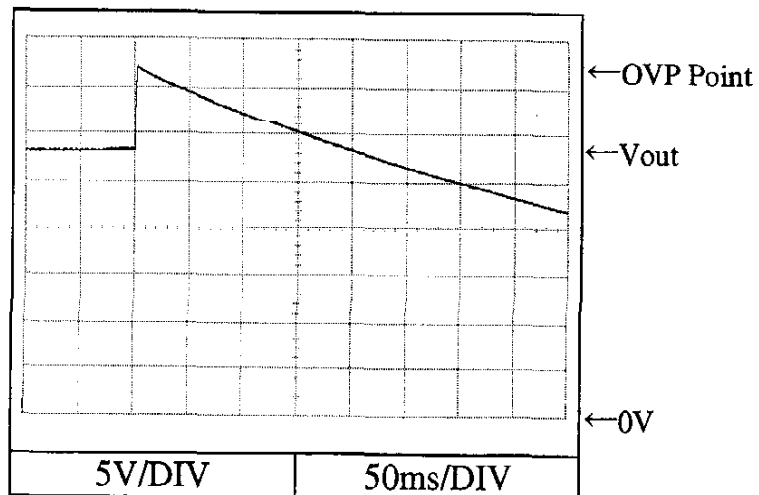

2.5 出力立ち上がり特性
Output rise characteristics

Conditions Vin : 48 VDC
Iout : 0 %
Tbp : 25 °C

12V

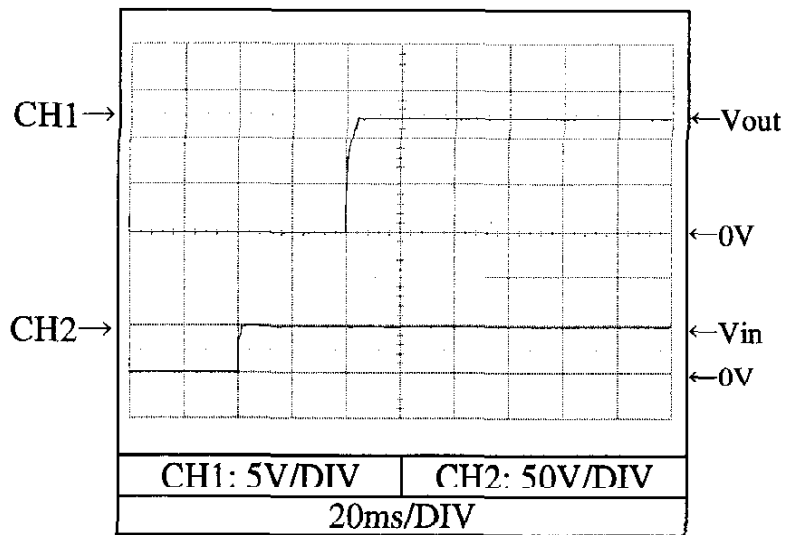

28V

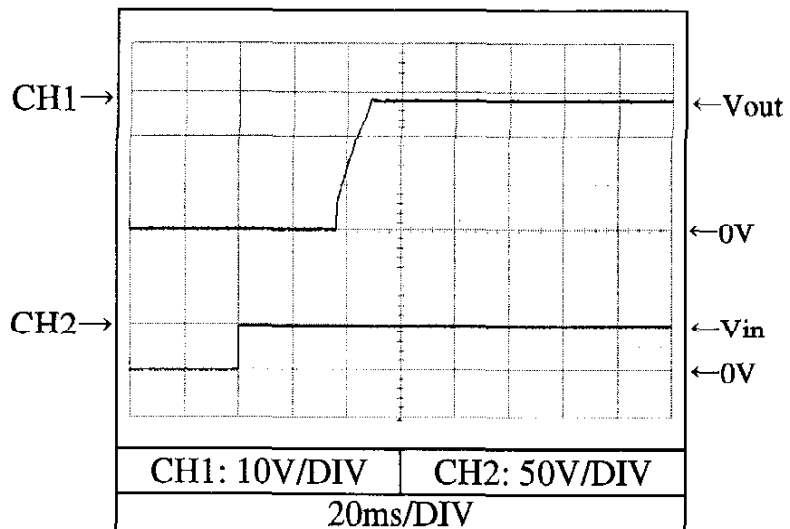

2.5 出力立ち上がり特性
Output rise characteristics

Conditions Vin : 48 VDC
Iout : 100 %
Tbp : 25 °C

12V

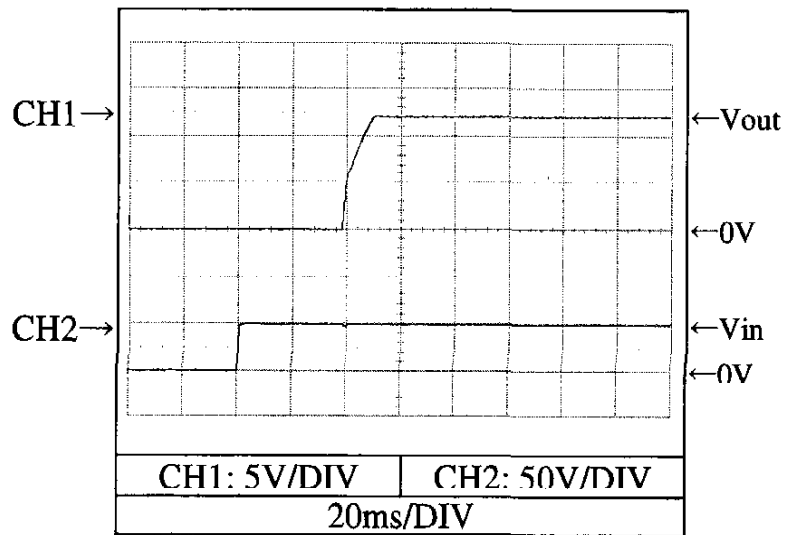

28V

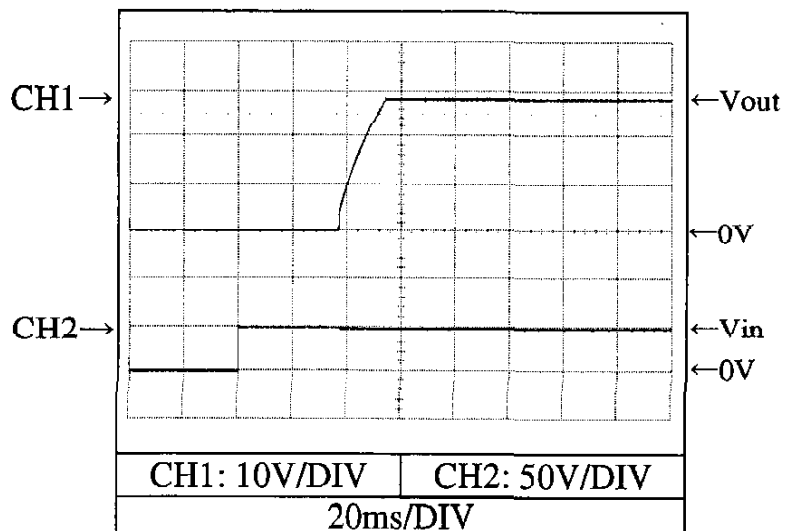

2.6 出力立ち下がり特性
Output fall characteristics

Conditions V_{in} : 48 VDC
 I_{out} : 0 %
 T_{bp} : 25 °C

12V

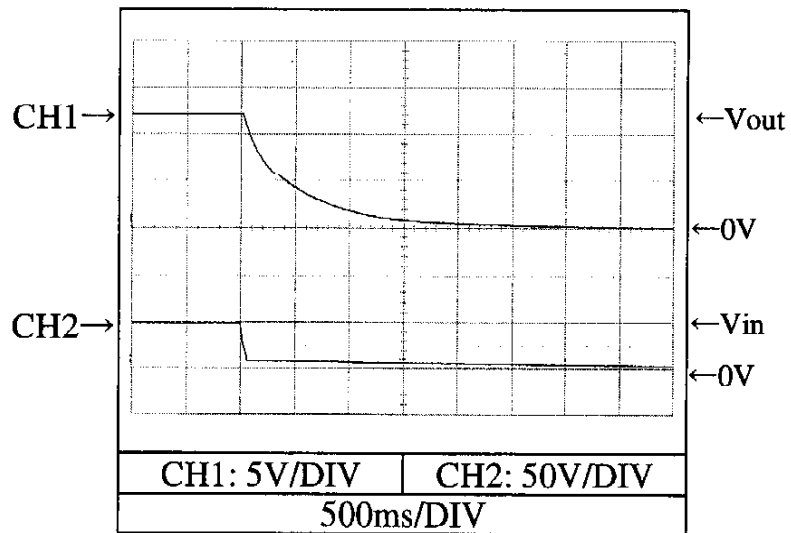

28V

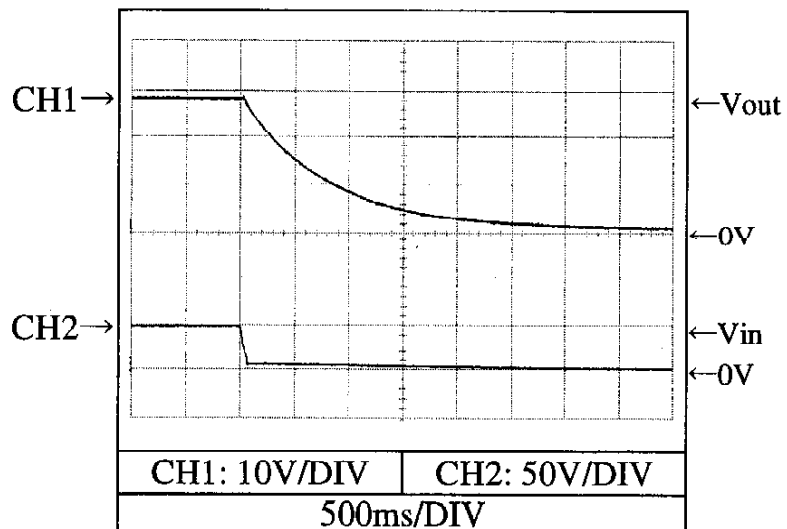

2.6 出力立ち下がり特性
Output rise characteristics

Conditions Vin : 48 VDC
Iout : 100 %
Tbp : 25 °C

12V

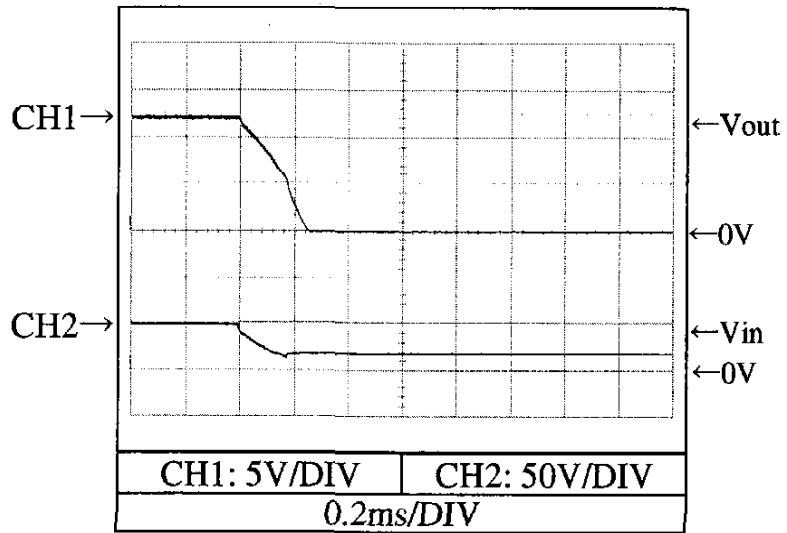

28V

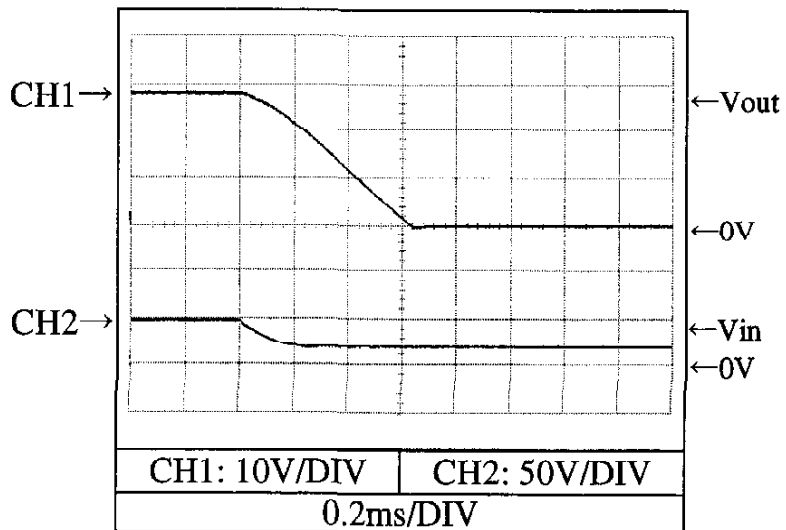

2.7 出力立ち上がり特性 (ON/OFFコントロール時)
 Output rise characteristics with ON/OFF CONTROL

Conditions Vin : 48 VDC
 Iout : 0 %
 Tbp : 25 °C

12V

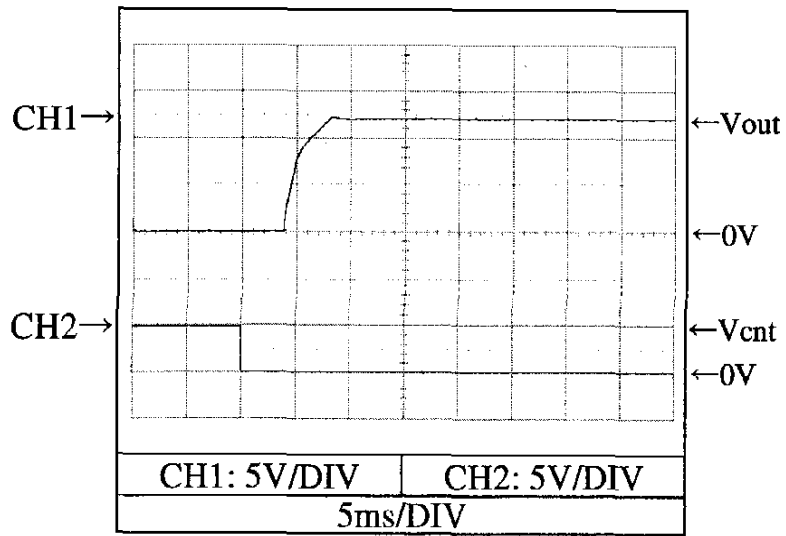

28V

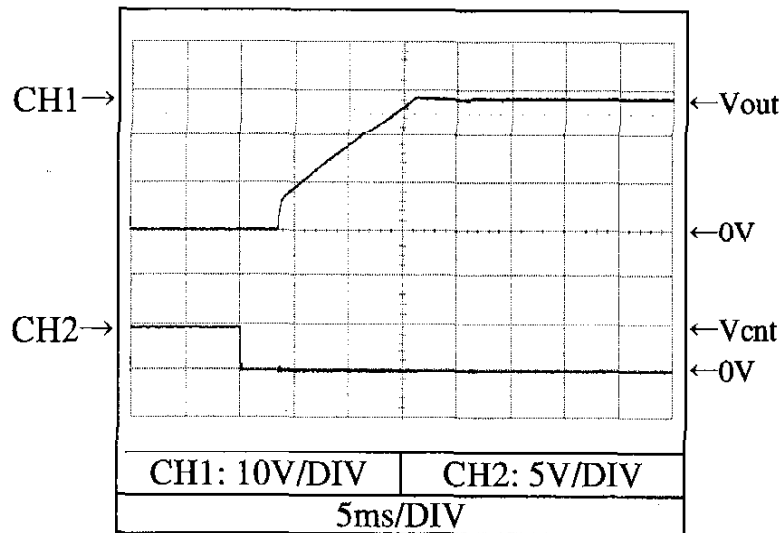

2.7 出力立ち上がり特性 (ON/OFFコントロール時)
Output rise characteristics with ON/OFF CONTROL

Conditions Vin : 48 VDC
Iout : 100 %
Tbp : 25 °C

12V

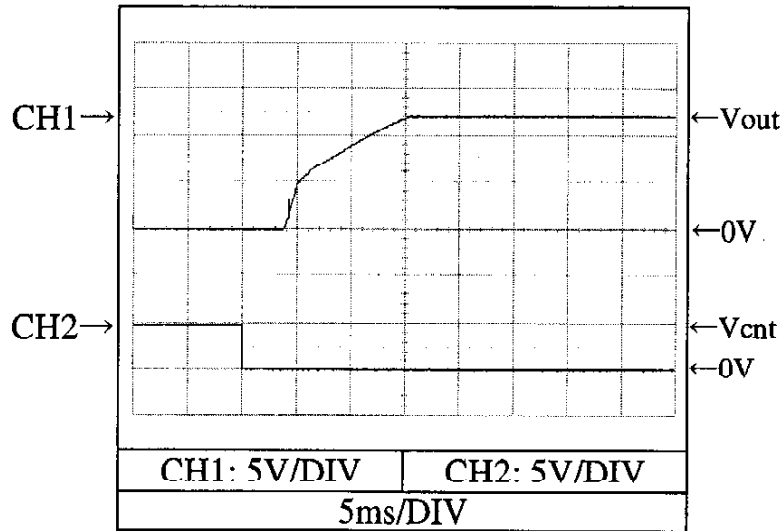

28V

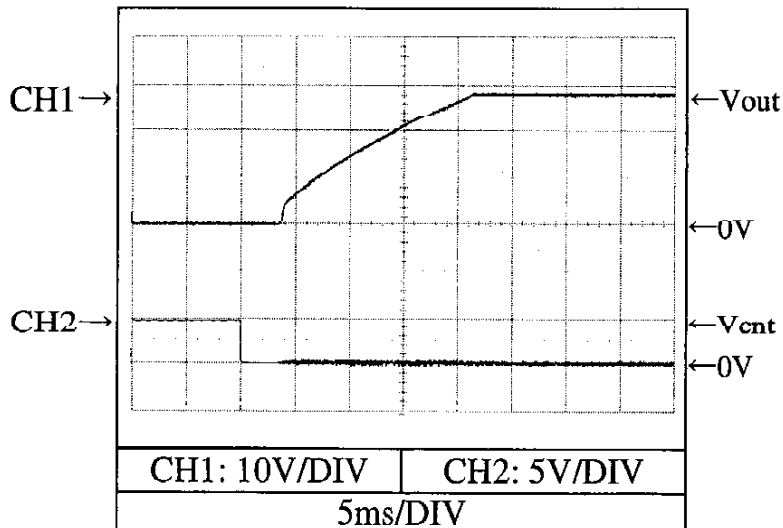

2.8 出力立ち下がり特性 (ON/OFFコントロール時)
Output fall characteristics with ON/OFF CONTROL

Conditions Vin : 48 VDC
Iout : 0 %
Tbp : 25 °C

12V

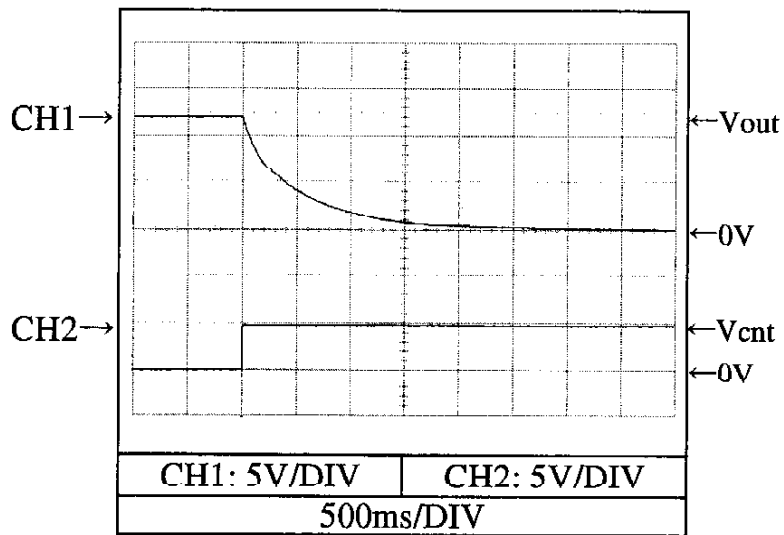

28V

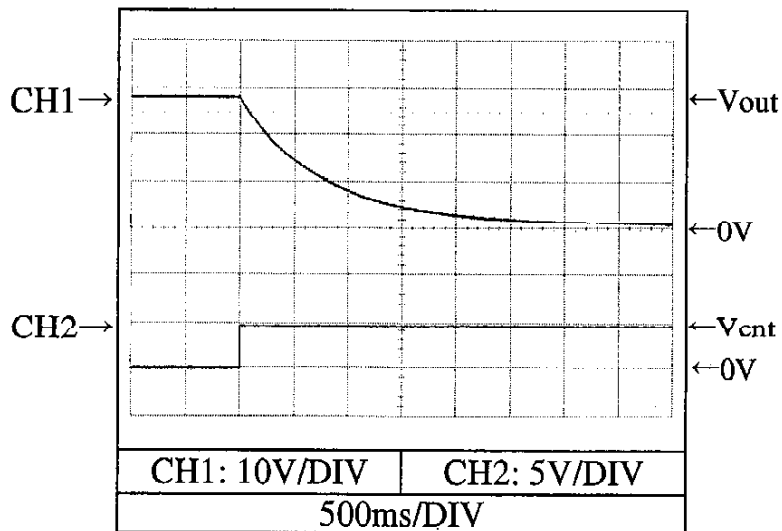

2.8 出力立ち下がり特性 (ON/OFFコントロール時)
 Output fall characteristics with ON/OFF CONTROL

Conditions Vin : 48 VDC
 Iout : 100 %
 Tbp : 25 °C

12V

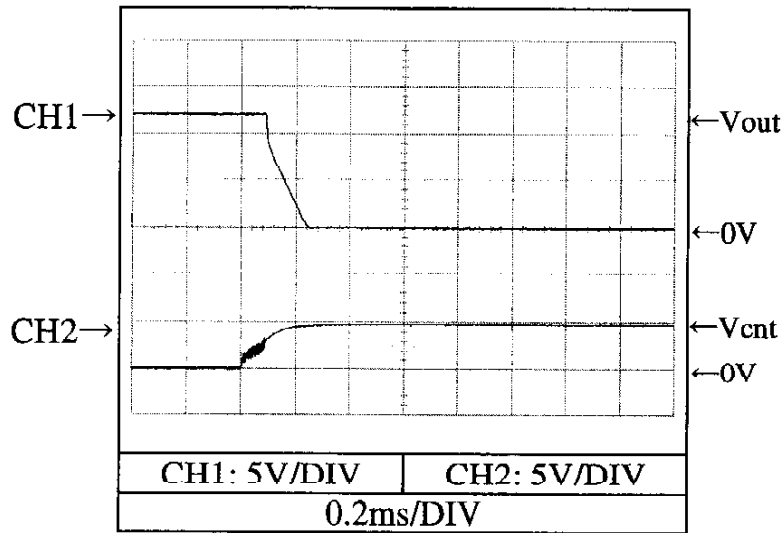

28V

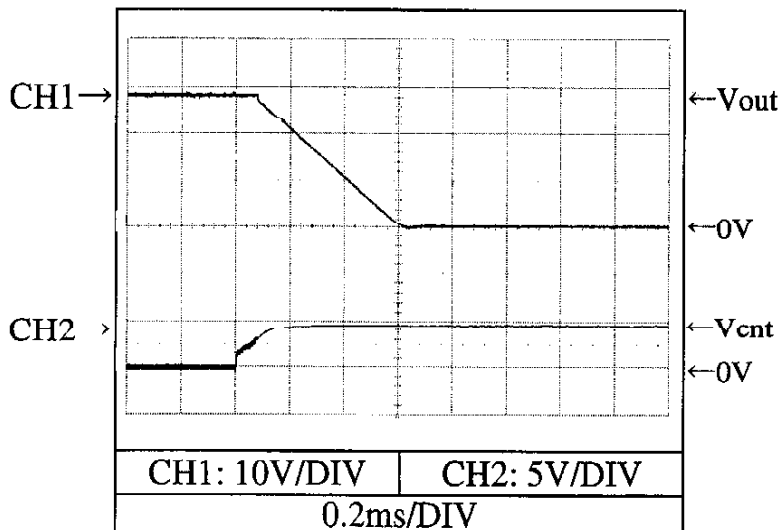

2.9 過渡応答（負荷急変）特性
Dynamic load response characteristics

Conditions Vin : 48 VDC
Tbp : 25 °C

12V

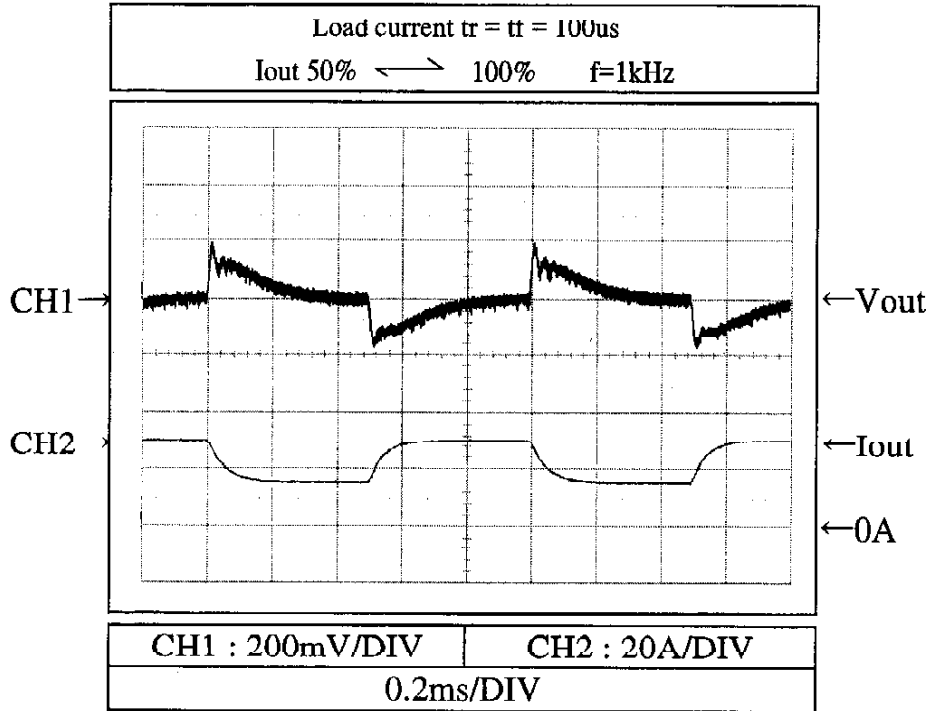

28V

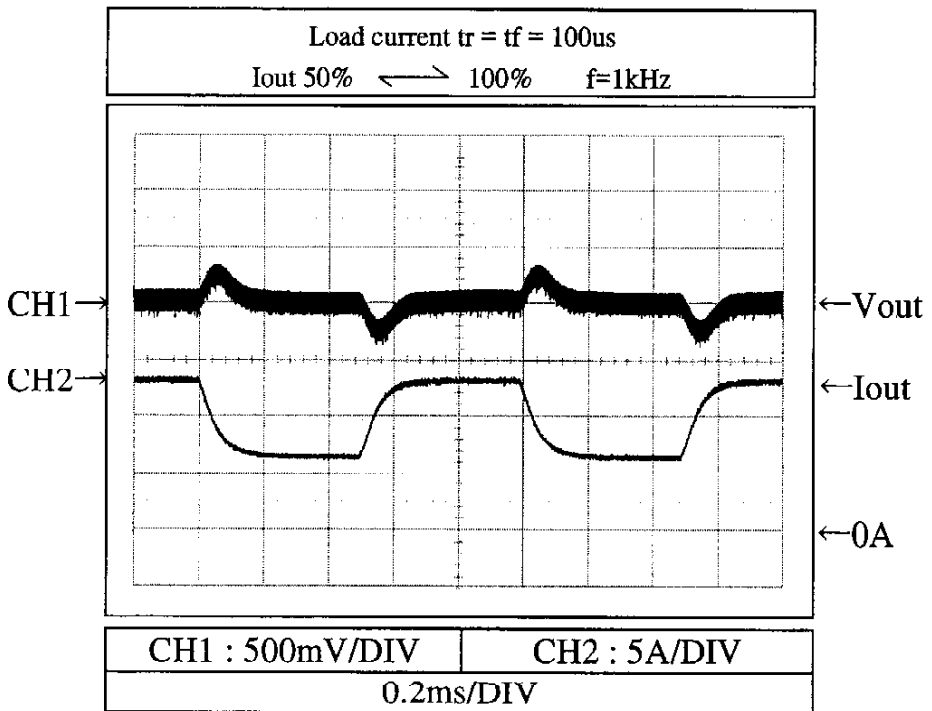

2.10 入力リッジ電流（突入電流）特性
Inrush current waveform

Conditions V_{in} : 48 VDC
 I_{out} : 100 %
 T_{bp} : 25 °C

28V

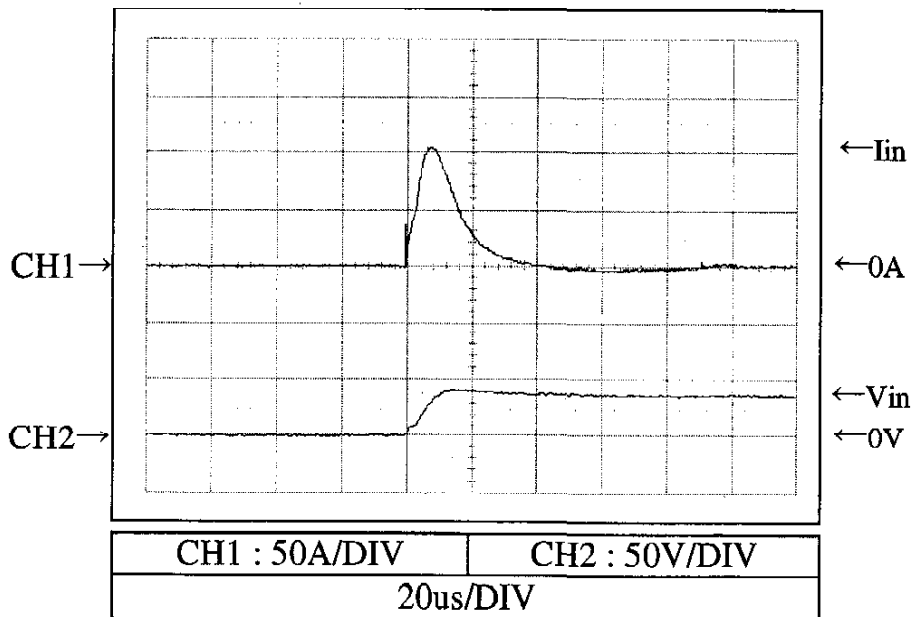

2.11 出力リップル、ノイズ波形
Output ripple and noise waveform

Conditions V_{in} : 48 VDC
 I_{out} : 100 %
 T_{bp} : 25 °C

12V

Normal mode

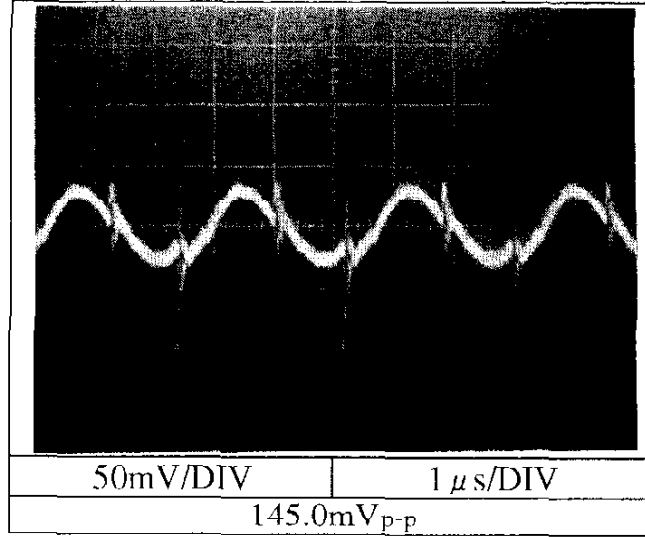

Normal + common mode

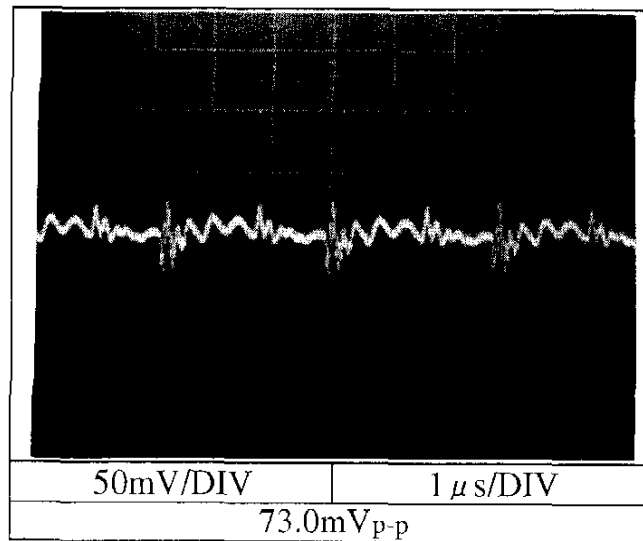

2.11 出力リップル、ノイズ波形
Output ripple and noise waveform

Conditions V_{in} : 48 VDC
 I_{out} : 100 %
 T_{bp} : 25 °C

28V

Normal mode

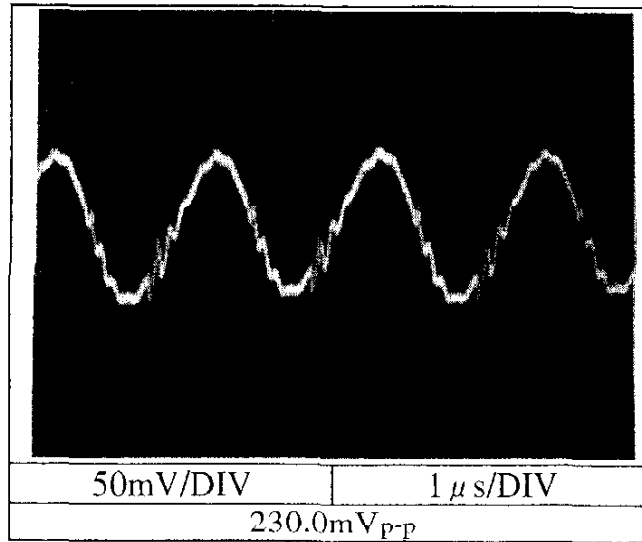

Normal + common mode

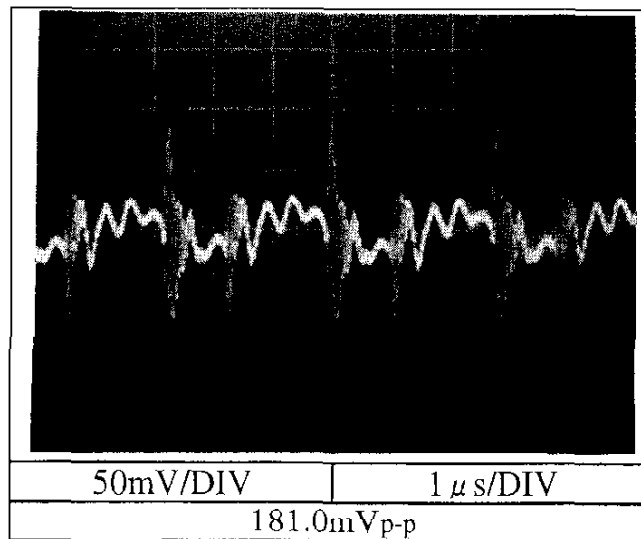

2.12 EMI特性

Electro-Magnetic Interference characteristics

(a) 雑音端子電圧 (帰還ノイズ)

Conducted Emission

(1) VCCI class A 対応アプリケーションシステム

VCCI class A application system

Conditions Vin : 48 VDC

Iout : 100 %

Tbp : 25 °C

12V

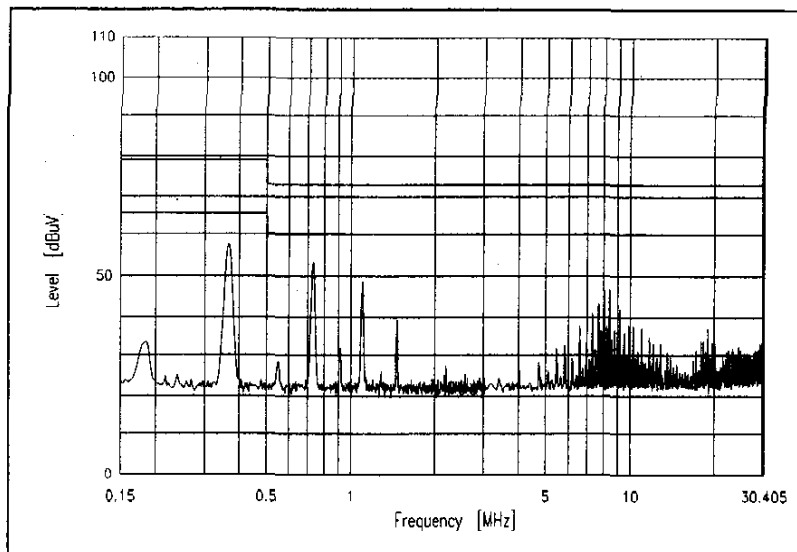

VCCI classA
QP Limit

VCCI classA
AV Limit

28V

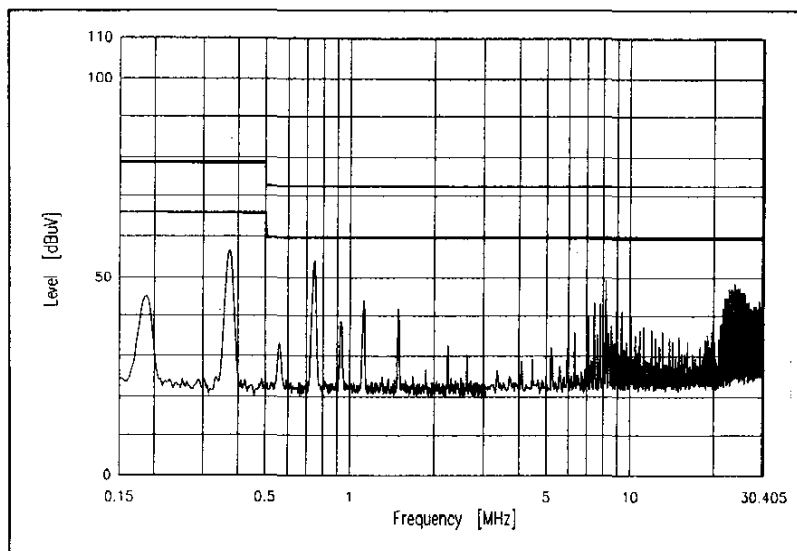

VCCI classA
QP Limit

VCCI classA
AV Limit

EMI特性

Electro-Magnetic Interference characteristics

(b) 雑音電界強度 (輻射ノイズ)

Radiated Emission

(1) VCCI class A 対応アプリケーションシステム

VCCI class A application system

Conditions Vin : 48 VDC

Iout : 100 %

Tbp : 25 °C

12V

HORIZONTAL:

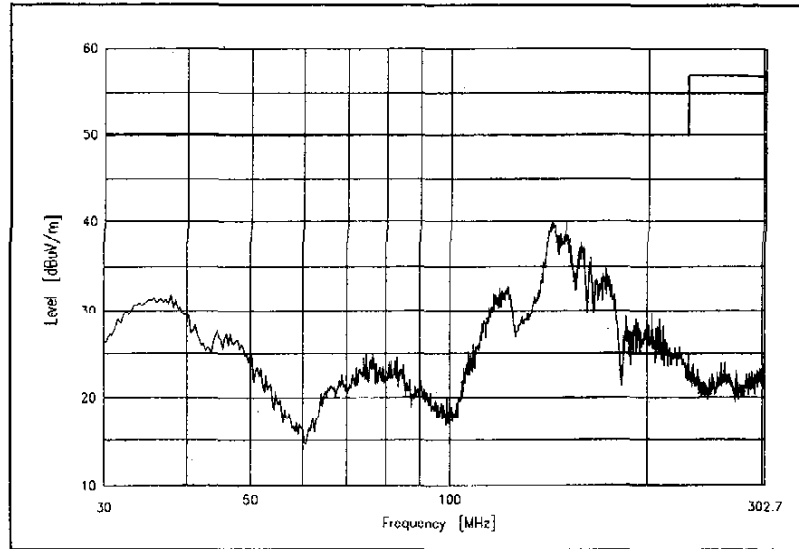

VCCI class A
QP Limit

VERTICAL:

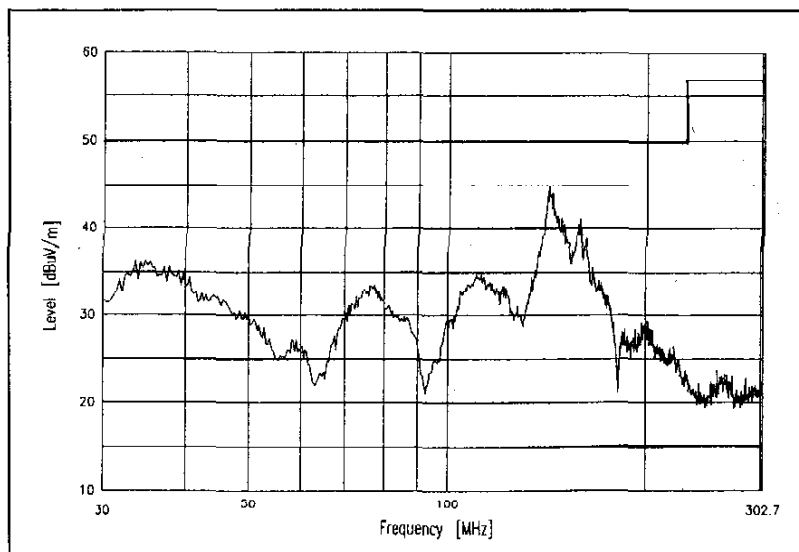

VCCI class A
QP Limit

EMI特性

Electro-Magnetic Interference characteristics

(b) 雑音電界強度 (輻射ノイズ)

Radiated Emission

(1) VCCI class A 対応アプリケーションシステム

VCCI class A application system

Conditions Vin : 48 VDC

Iout : 100 %

Tbp : 25 °C

28V

HORIZONTAL:

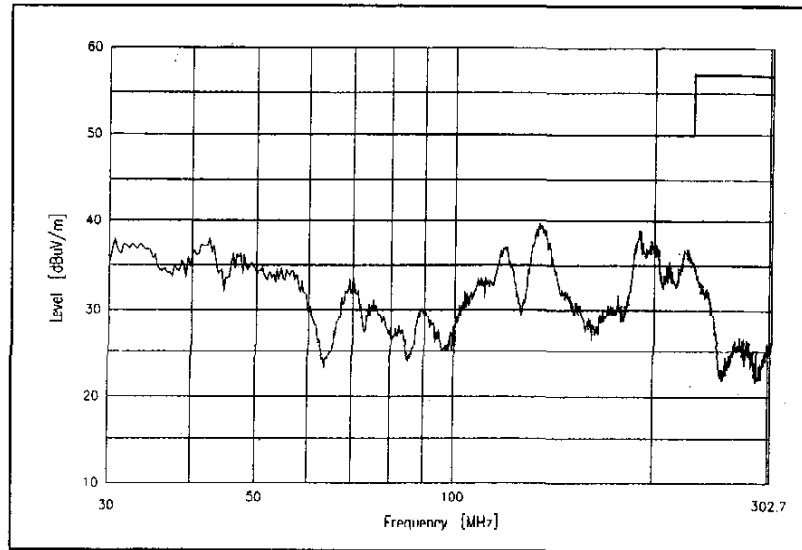

VCCI classA
QP Limit

VERTICAL:

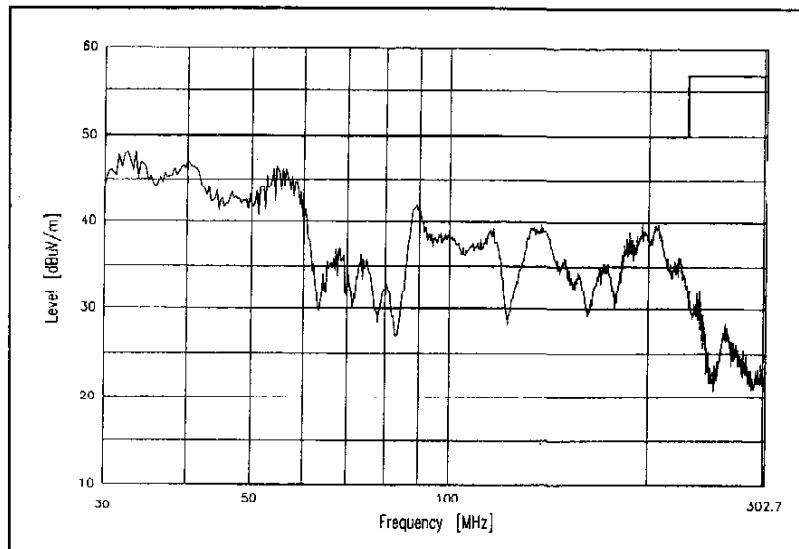

VCCI classA
QP Limit