

PAQ100S48-*

EVALUATION DATA

型式データ

DWG.No. C163-53-01B

DENSEI-LAMBDA

INDEX

1. 測定方法	Evaluation Method	PAGE
1.1	測定回路 Circuits used for determination	T-1~5
	(1) 静特性 Steady state data	
	(2) 通電ドリフト特性 Warm up voltage drift characteristics	
	(3) 過電流保護特性 Over current protection (OCP) characteristics	
	(4) 過電圧保護特性 Over voltage protection (OVP) characteristics	
	(5) 出力立ち上がり特性 Output rise characteristics	
	(6) 出力立ち下がり特性 Output fall characteristics	
	(7) 出力立ち上がり特性 (ON/OFFコントロール時) Output rise characteristics with ON/OFF CONTROL	
	(8) 出力立ち下がり特性 (ON/OFFコントロール時) Output fall characteristics with ON/OFF CONTROL	
	(9) 過渡応答 (負荷急変) 特性 Dynamic load response characteristics	
	(10) 入力サージ電流 (突入電流) 特性 Inrush current characteristics	
	(11) 出力リップル、ノイズ波形 Output ripple and noise waveform	
	(12) EMI特性 Electro-Magnetic Interference characteristics	
1.2	使用測定機器 List of equipments used	T-6
2.	特性データ Characteristics	
2.1	(1) 入力・負荷・温度変動 Regulation - line and load, temperature drift	T-7~8
	(2) 出力電圧・リップル電圧対入力電圧 Output voltage and ripple voltage v.s. input voltage	T-9~10
	(3) 効率・入力電流対出力電流 Efficiency and input current v.s. output current	T-11~13
	(4) 効率対入力電圧 Efficiency v.s. input voltage	T-14~16
	(5) 効率対周囲温度 Efficiency v.s. ambient temperature	T-17~19
2.2	通電ドリフト特性 Warm up voltage drift characteristics	T-20
2.3	過電流保護特性 Over current protection (OCP) characteristics	T-21~24
2.4	過電圧保護特性 Over voltage protection (OVP) characteristics	T-25
2.5	出力立ち上がり特性 Output rise characteristics	T-26~27
2.6	出力立ち下がり特性 Output fall characteristics	T-28~29
2.7	出力立ち上がり特性 (ON/OFFコントロール時) Output rise characteristics with ON/OFF CONTROL	T-30~31
2.8	出力立ち下がり特性 (ON/OFFコントロール時) Output fall characteristics with ON/OFF CONTROL	T-32~33

2.9 過渡応答（負荷急変）特性 Dynamic load response characteristics T-34~35

2.10 入力サージ電流（突入電流）特性 Inrush current waveform T-36

2.11 出力リップル、ノイズ波形 Output ripple and noise waveform T-37

2.12 EMI特性 Electro-Magnetic Interference characteristics

 VCCI class A 対応アプリケーションシステム

 VCCI class A application system T-38~42

使用記号 Terminology used

	Definition	
Vin 入力電圧	Input Voltage
Vout 出力電圧	Output Voltage
VCNT CNT電圧	CNT Voltage
Iin 入力電流	Input Current
Iout 出力電流	Output Current
Ta 周囲温度	Ambient Temperature

1. 測定方法 Evaluation Method

1.1 測定回路 Circuits used for determination

(1) 静特性 Steady state data

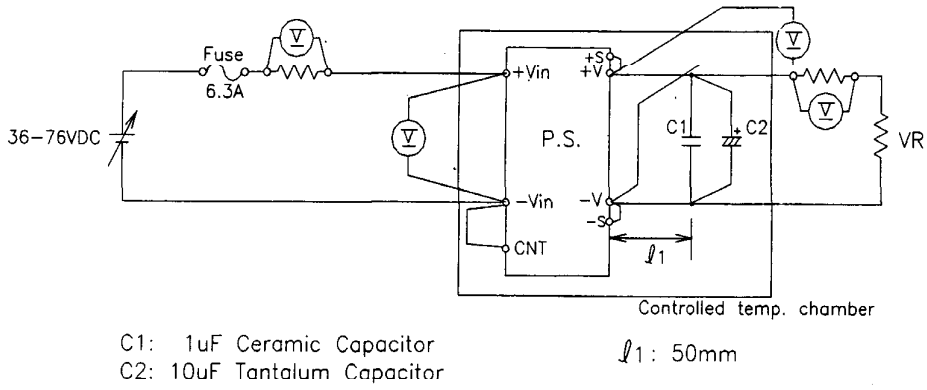

(2) 通電ドリフト Warm up voltage drift characteristics

静特性と同じ

Same as Steady state data

(3) 過電流保護特性 Over current protection (OCP) characteristics

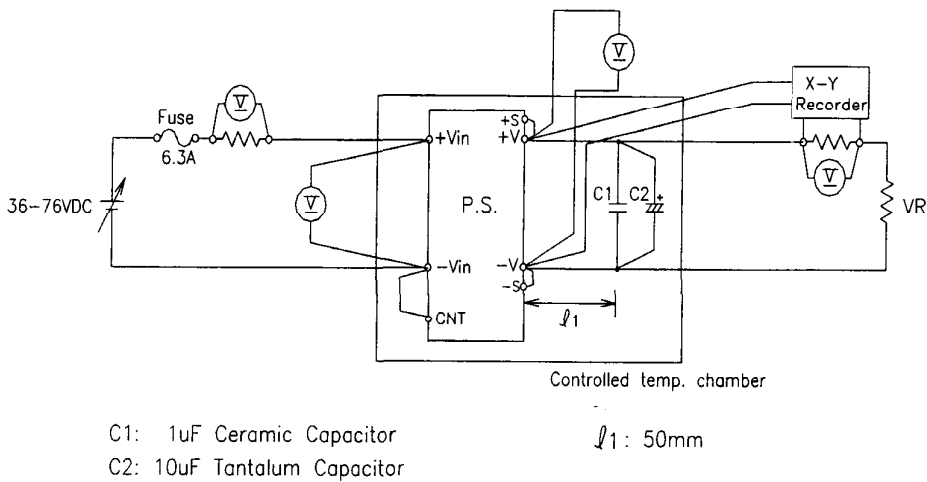

(4) 過電圧保護特性 Over voltage protection (OVP) characteristics

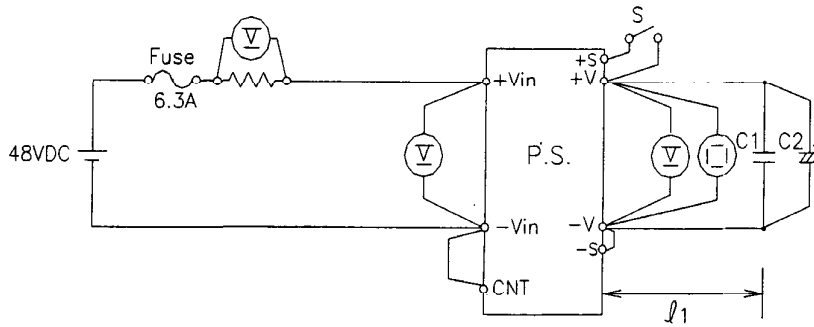

C1: 1uF Ceramic Capacitor
C2: 10uF Tantalum Capacitor

l_1 : 50mm

(5) 出力立ち上がり特性 Output rise characteristics

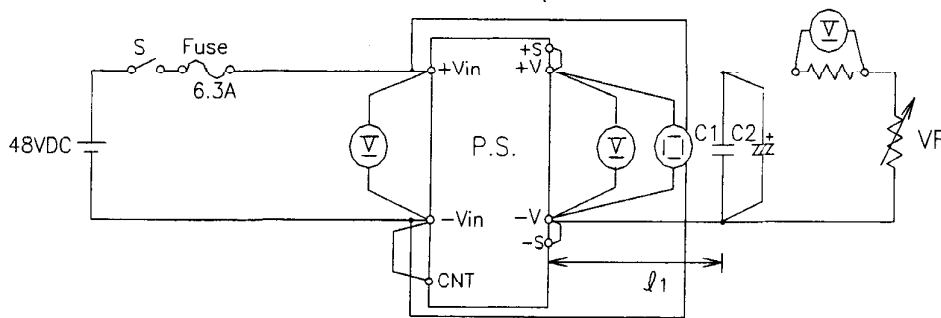

C1: 1uF Ceramic Capacitor
C2: 10uF Tantalum Capacitor

l_1 : 50mm

(6) 出力立ち下がり Output fall characteristics

出力立ち上がり特性と同じ

Same as output rise characteristics

(7) 出力立ち上がり特性 (ON/OFFコントロール時)

Output rise characteristics with ON/OFF CONTROL

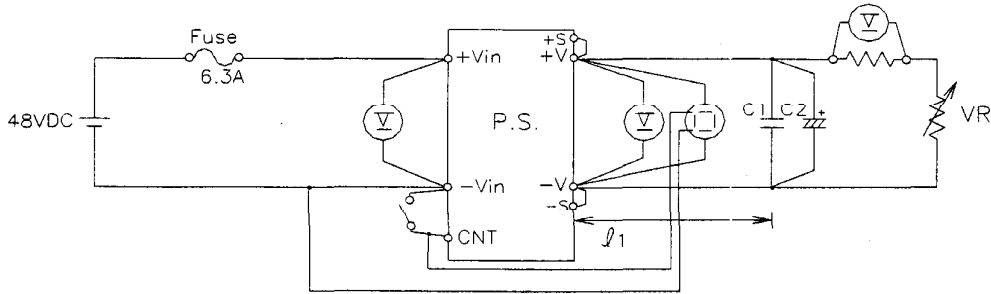

C1: 1uF Ceramic Capacitor
C2: 10uF Tantalum Capacitor

l_1 : 50mm

(8) 出力立ち下がり特性 (ON/OFFコントロール時)

Output fall characteristics with ON/OFF CONTROL

出力立ち上がり特性 (ON/OFFコントロール時) と同じ

Same as output rise characteristics with ON/OFF CONTROL

(9) 過渡応答(負荷急変)特性 Dynamic load response characteristics

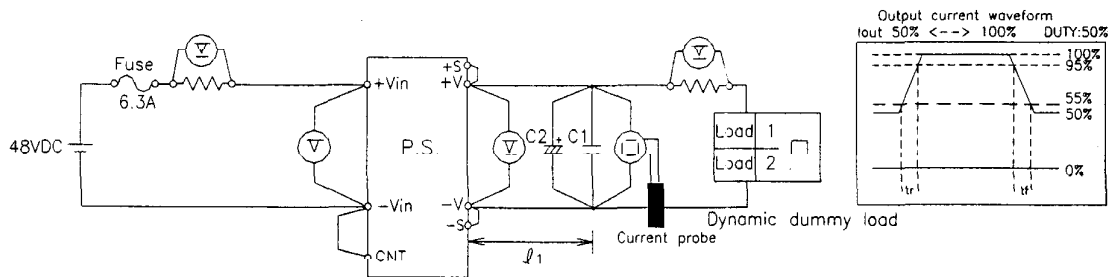

C1: 1uF Ceramic Capacitor
C2: 10uF Tantalum Capacitor

l_1 : 50mm

(10) 入力サージ電流 (突入電流) 特性 Inrush current characteristics

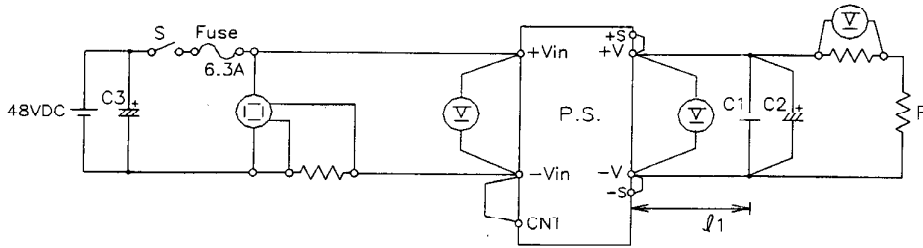

C1: 1uF Ceramic Capacitor
 C2: 10uF Tantalum Capacitor
 l_1 : 50mm

(11) 出力リップル、ノイズ波形 Output ripple and noise waveform

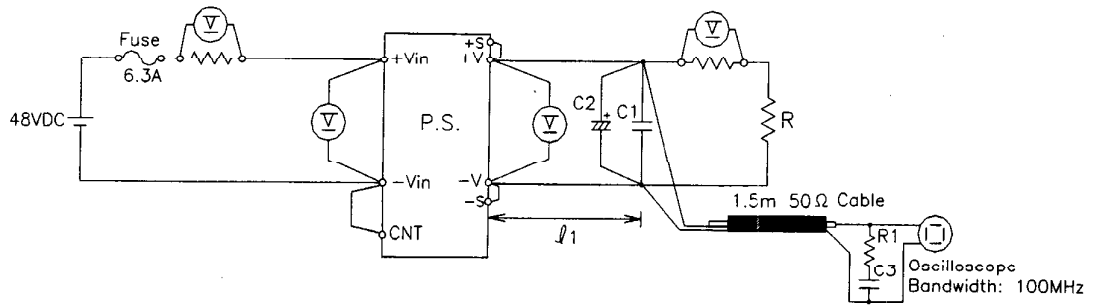

C1: 1uF Ceramic Capacitor
 C2: 10uF Tantalum Capacitor
 C3: 4700pF Film Capacitor
 R1: 50 Ω
 l_1 : 50mm

(12) EMI 特性 Electro-Magnetic Interference characteristics

(a) 雑音端子電圧 (帰還ノイズ) Conducted Emission Noise

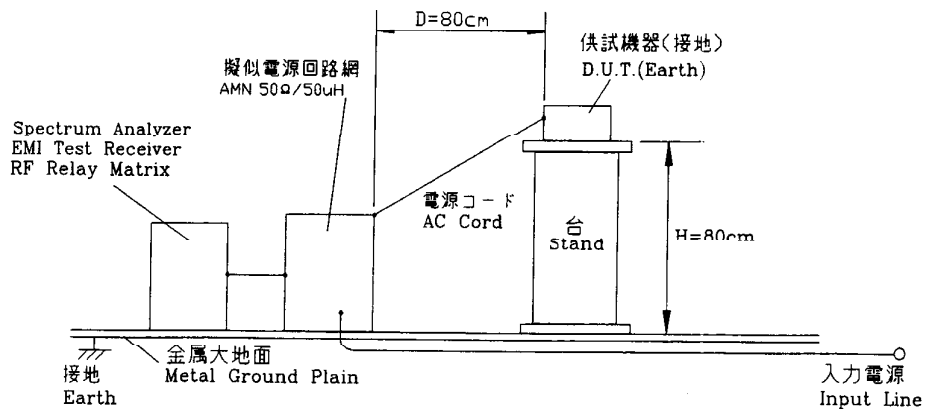

(b) 雑音電界強度 (輻射ノイズ) Radiated Emission Noise

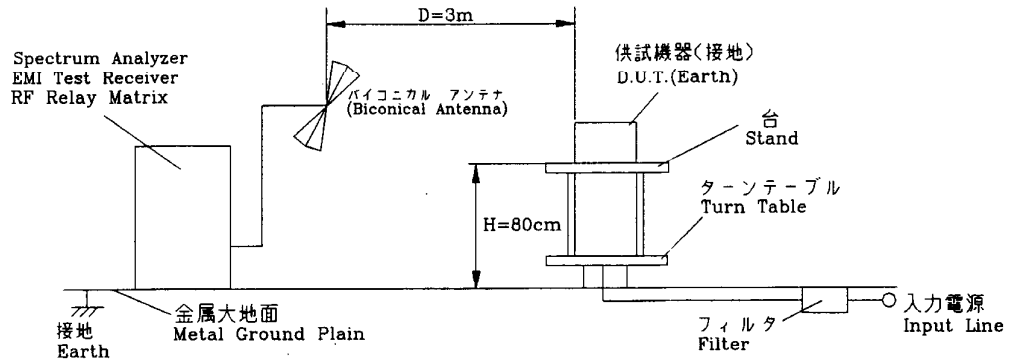

(1) VCC class A 対応対応アプリケーションシステム

VCCI class A application system

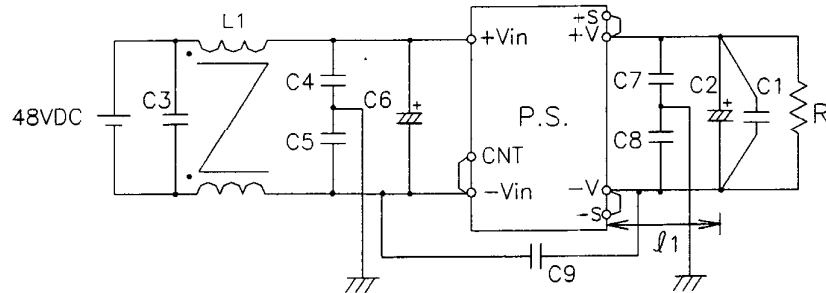

- L1 : 1mH
- C1 : 1uF Ceramic Capacitor
- C2 : 10uF Tantalum Capacitor
- C3 : 1uF Film Capacitor
- C4,C5 : 0.068uF Film Capacitor
- C6 : 470uF Electrolytic Capacitor
- C7,C8 : 0.033uF Film Capacitor
- C9 : 2200pF Ceramic Capacitor
- $\varnothing 1$: 50mm

1.2 使用測定機器 List of equipment used

	EQUIPMENT USED	MANUFACTURER	MODEL NO.
1	OSCILLO SCOPE	HITACHI DENSHI	V-1100A
2	DIGITAL STORAGE OSCILLOSCOPE	IWATSU-LECLOY	LT364L
3	DIGITAL MULTIMETER	ADVANTEST	R6341A
4	DIGITAL POWER METER	YOKOGAWA ELECT.	WT110
5	CURRENT PROBE/AMPLIFIER	TEKTRONIX	A6303/AM503
6	SHUNT REGISTER	YOKOGAWA ELECT.	2215
7	X-Y RECORDER	GRAPHTEC	WX4309
8	CONTROLLED TEMP. CHANBER	TABAI ESPEC	SH-240
9	SPECTRUM ANALYZER	ROHDE & SCHWARZ	FSA
10	EMI TEST RECEIVER	ROHDE & SCHWARZ	ESHS10
11	EMI TEST RECEIVER	ROHDE & SCHWARZ	ESVS10
12	RF RELAY MATRIX	ROHDE & SCHWARZ	PSU
13	AMN	KYORITU DENSHI	KNW-242
14	ANTENNA(BICONICAL ANTENNA)	SCHWARZBECK	BBA9106
15	DYNAMIC DUMMY LOAD	TAKASAGO	FK-1000L
16	AC POWER SUPPLY	KIKUSUI	PCR4000L

2. 特性データ

2.1 静特性 Steady state data

(1) 入力、負荷、温度変動 Regulation - line and load, temperature drift

1.8V

1. Regulation - line and load

condition Ta : 25°C

Air Velocity : 2m/s

Iout \ Vin	36VDC	48VDC	76VDC	line regulation	
0%	1.7917V	1.7917V	1.7918V	0.1mV	0.006%
50%	1.7919V	1.7919V	1.7918V	0.1mV	0.006%
100%	1.7919V	1.7919V	1.7917V	0.2mV	0.011%
load regulation	0.2mV	0.2mV	0.1mV		
	0.011%	0.011%	0.006%		

2. Temperature drift

conditions Vin : 48VDC

Iout : 100%

Air Velocity : 2m/s

Ta	-40°C	25°C	70°C	temperature stability	
Vout	1.7976V	1.7919V	1.7899V	7.7mV	0.428%

3.3V

1. Regulation - line and load

condition Ta : 25°C

Air Velocity : 2m/s

Iout \ Vin	36VDC	48VDC	76VDC	line regulation	
0%	3.2931V	3.2937V	3.2936V	0.6mV	0.018%
50%	3.2938V	3.2941V	3.2936V	0.5mV	0.015%
100%	3.2934V	3.2934V	3.2930V	0.4mV	0.012%
load regulation	0.7mV	0.6mV	0.6mV		
	0.021%	0.018%	0.018%		

2. Temperature drift

conditions Vin : 48VDC

Iout : 100%

Air Velocity : 2m/s

Ta	-40°C	25°C	60°C	temperature stability	
Vout	3.3048V	3.2934V	3.2829V	21.9mV	0.664%

2. 特性データ

2.1 静特性 Steady state data

(1) 入力、負荷、温度変動 Regulation - line and load, temperature drift

5V

1. Regulation - line and load

condition Ta : 25°C

Air Velocity : 2m/s

Iout \ Vin	36VDC	48VDC	76VDC	line regulation	
0%	4.9881V	4.9886V	4.9882V	0.5mV	0.010%
50%	4.9898V	4.9902V	4.9899V	0.4mV	0.008%
100%	4.9898V	4.9896V	4.9891V	0.7mV	0.014%
load regulation	1.7mV	1.6mV	1.7mV		
	0.034%	0.032%	0.034%		

2. Temperature drift

conditions Vin : 48VDC

Iout : 100%

Air Velocity : 2m/s

Ta	-40°C	25°C	60°C	temperature stability	
Vout	5.0099V	4.9896V	4.9817V	28.2mV	0.564%

2.1 (2) 出力電圧、リップル電圧対入力電圧
Output voltage and ripple voltage vs input voltage

Conditions Iout : 100 %
 Ta : -40 °C -----
 25 °C - · - · -
 70 °C _____
 Air Velocity : 2 m/s

1.8V

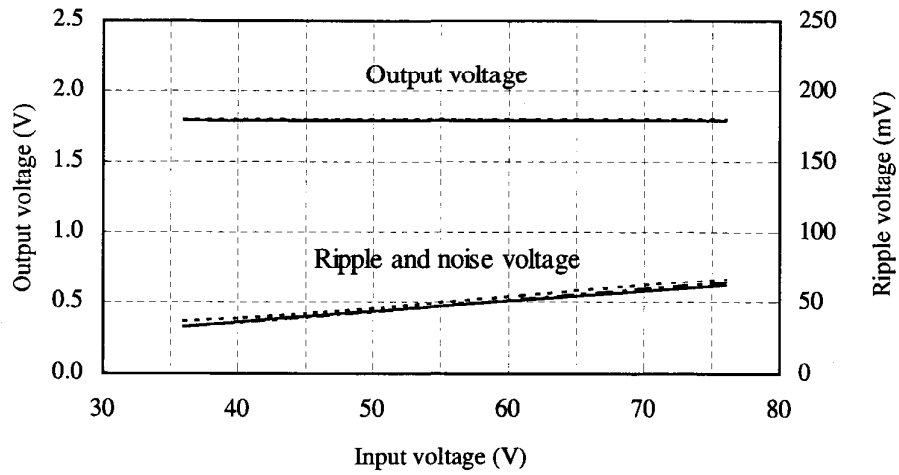

Ta : -40 °C -----
 25 °C - · - · -
 60 °C _____
 Air Velocity : 2 m/s

3.3V

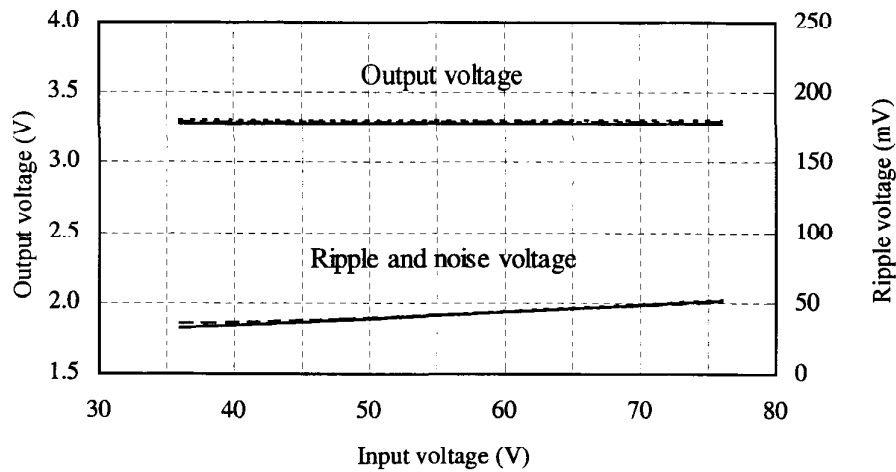

2.1 (2) 出力電圧、リップル電圧対入力電圧
Output voltage and ripple voltage vs input voltage

Conditions Iout : 100 %
 Ta : -40 °C -----
 25 °C -.-.-.-.-
 60 °C _____
 Air Velocity : 2 m/s

5V

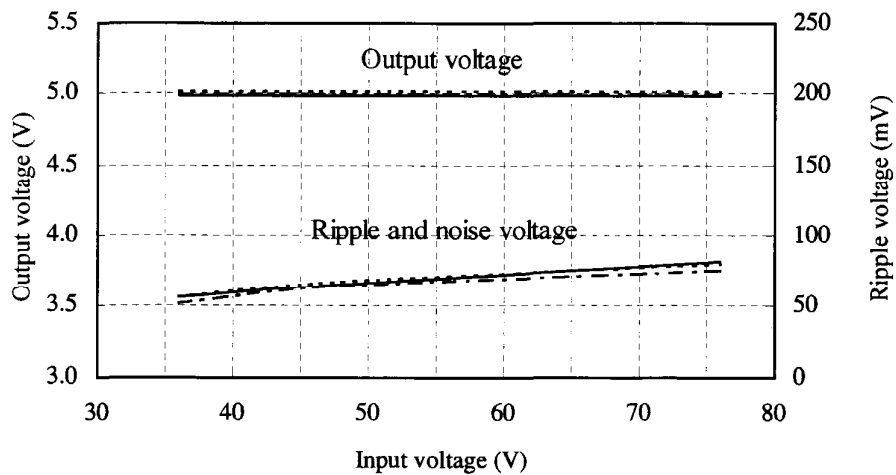

2.1 (3) 効率、入力電流対出力電流

Efficiency and input current vs output current

Conditions Vin : 36 VDC -----
 : 48 VDC - - - - -
 : 76 VDC ————
 Ta : 25 °C
 Air Velocity : 2 m/s

1.2V

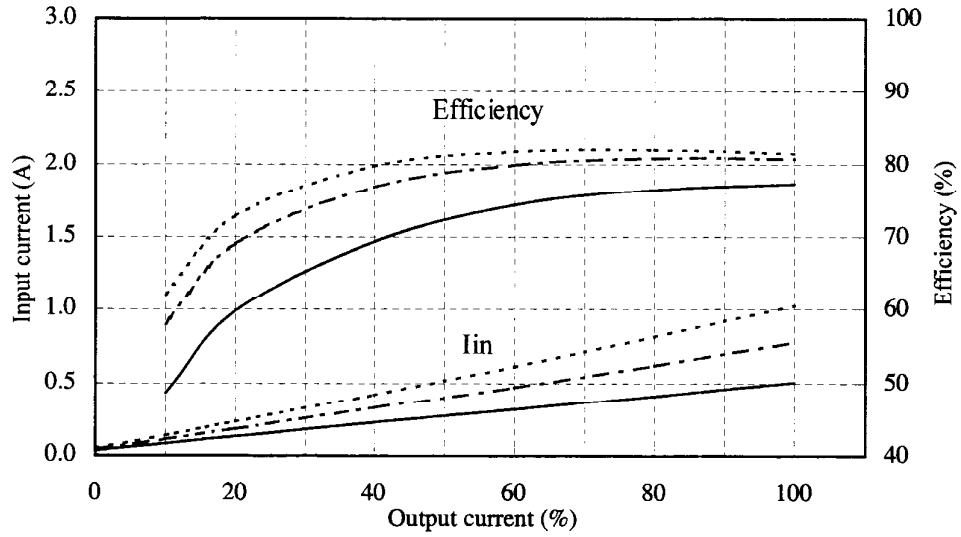

1.8V

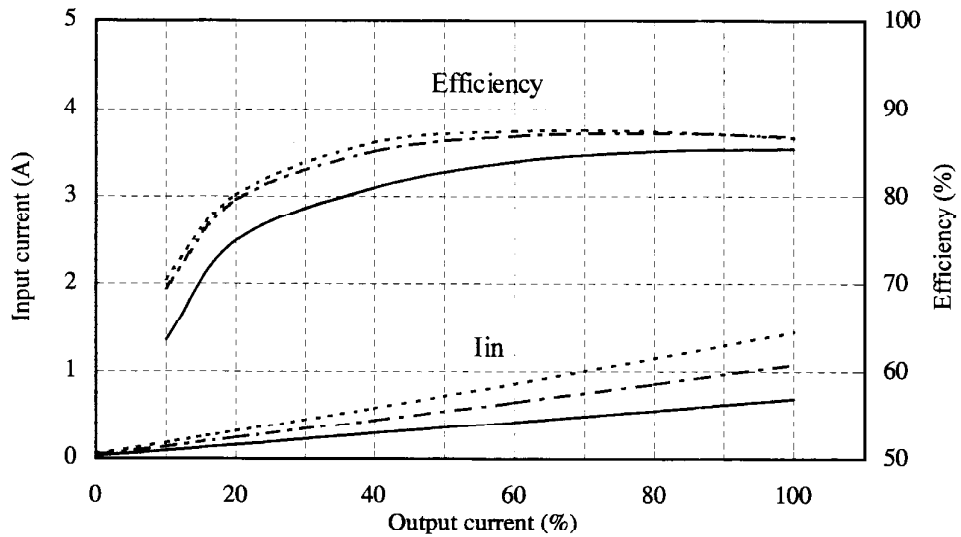

2.1 (3) 効率、入力電流対出力電流

Efficiency and input current vs output current

Conditions Vin : 36 VDC -----
 : 48 VDC - - - - -
 : 76 VDC ————
 Ta : 25 °C
 Air Velocity : 2 m/s

2.5V

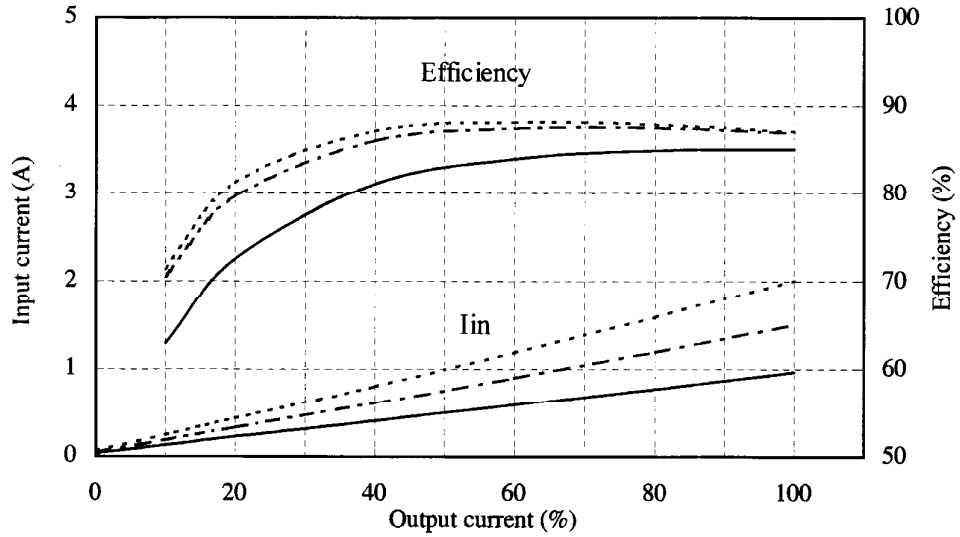

3.3V

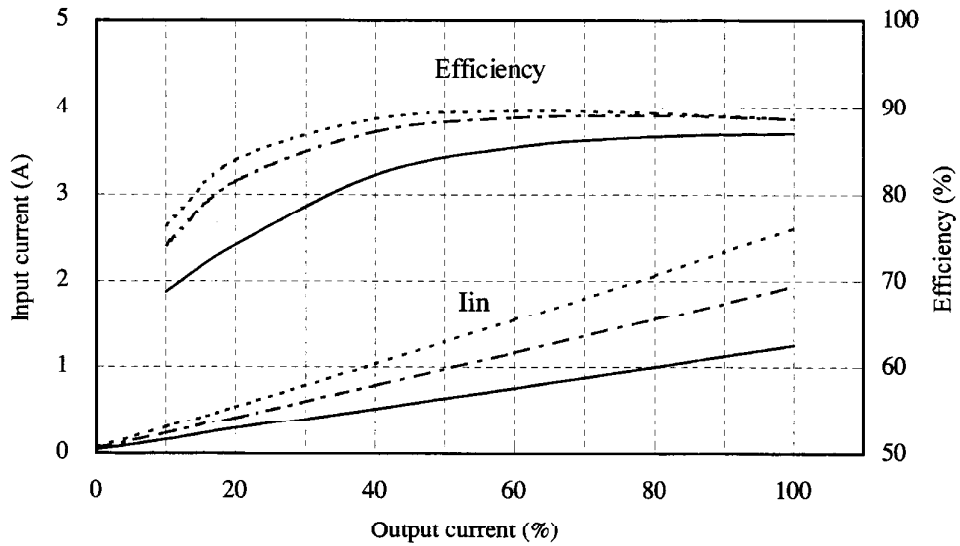

2.1 (3) 効率、入力電流対出力電流

Efficiency and input current vs output current

Conditions V_{in} : 36 VDC -----

: 48 VDC - - - - -

: 76 VDC ————

T_a : 25 °C

Air Velocity : 2 m/s

5V

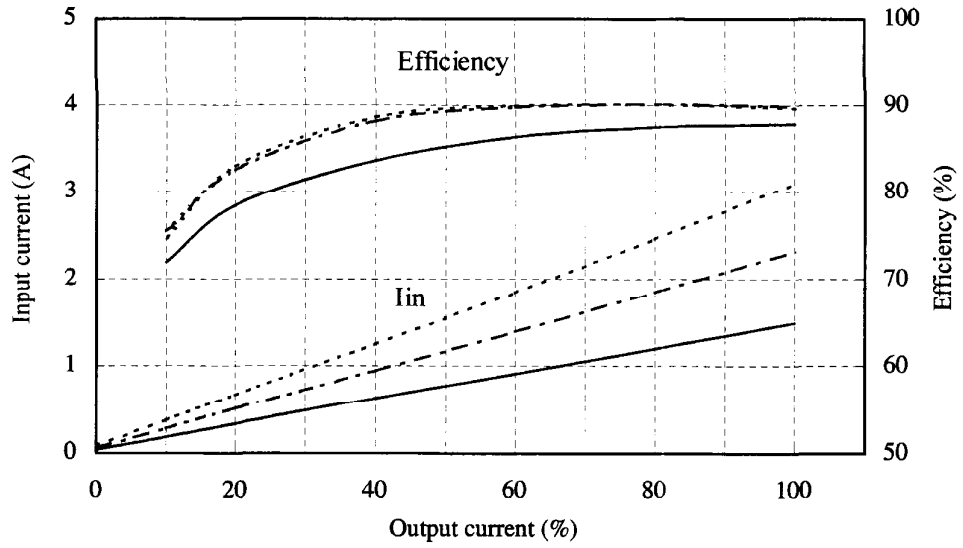

2.1 (4) 効率対入力電圧
Efficiency vs input voltage

Conditions Ta : 25 °C
 Iout : 50 % -----
 80 % -.-.-.-
 100 % _____
 Air Velocity : 2 m/s

1.2V

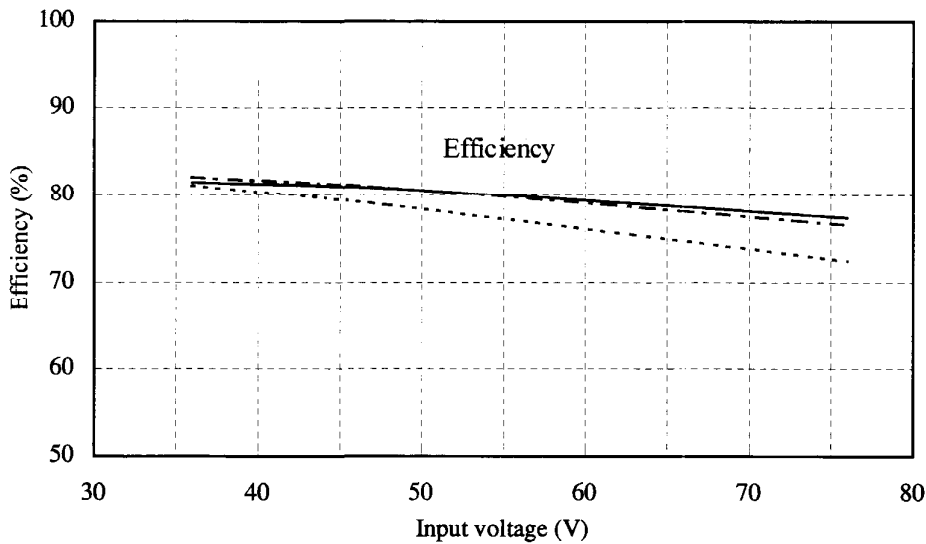

1.8V

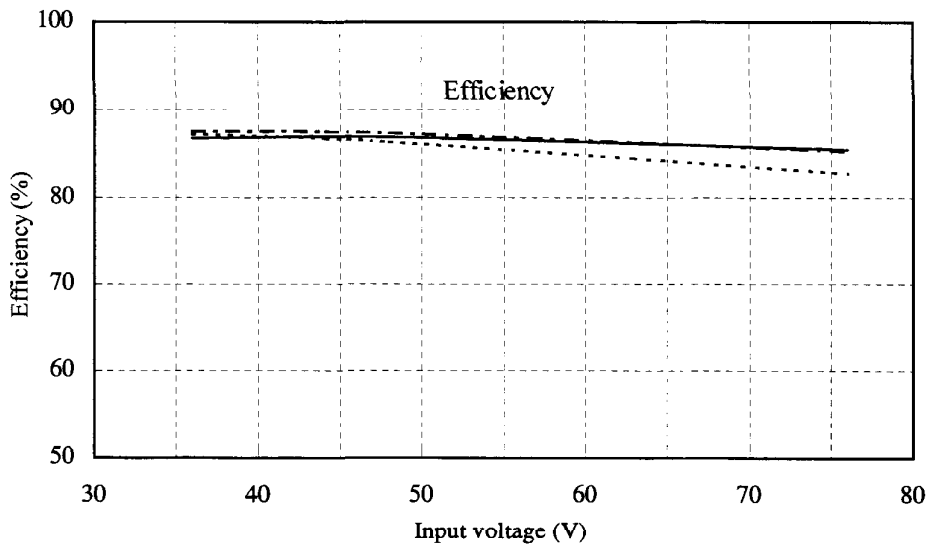

2.1 (4) 効率が対入力電圧
Efficiency vs input voltage

Conditions Ta : 25 °C
 Iout : 50 % -----
 80 % -.-.-.-
 100 % _____
 Air Velocity : 2 m/s

2.5V

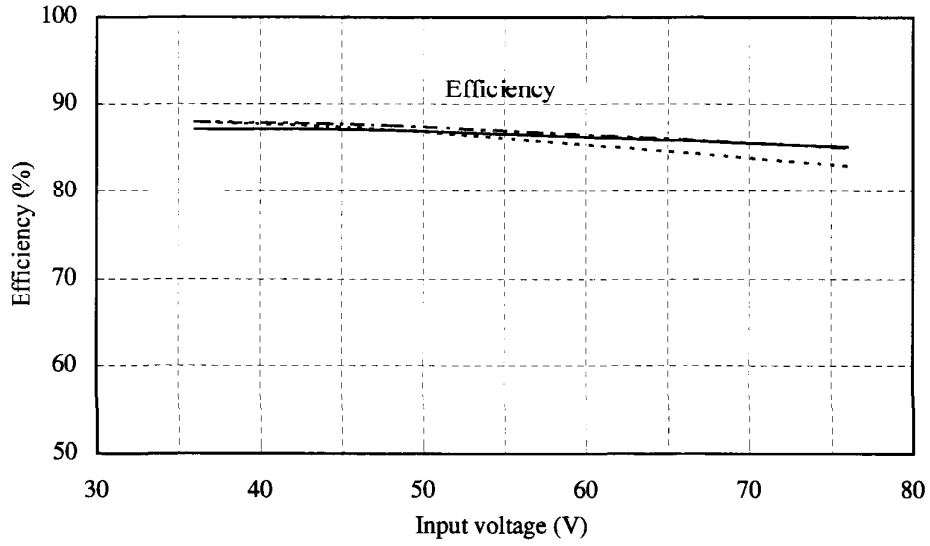

3.3V

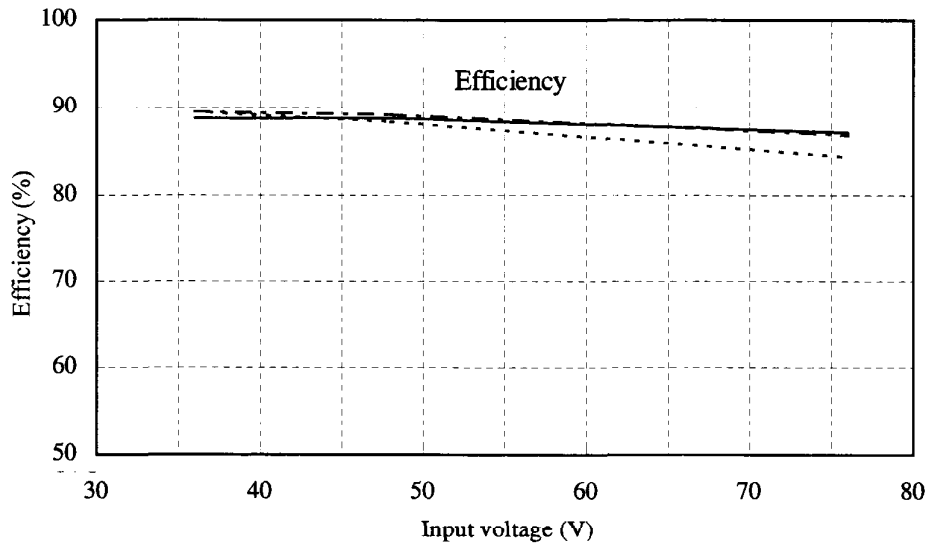

2.1 (4) 効率対入力電圧
Efficiency vs input voltage

Conditions Ta : 25 °C
Iout : 50 % -----
80 % -.-.-.-
100 % _____
Air Velocity : 2 m/s

5V

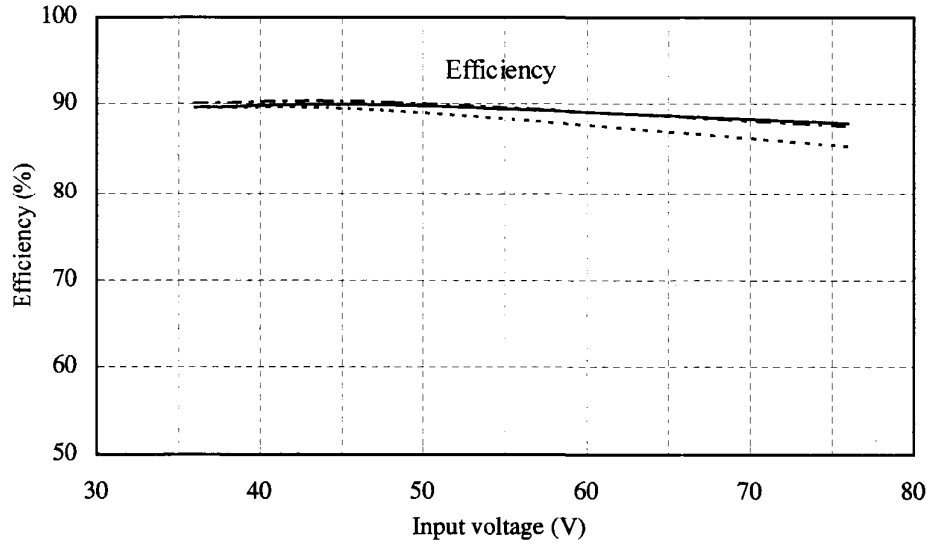

2.1 (5) 効率対周囲温度
Efficiency vs ambient temperature

Conditions Vin : 48 VDC
Iout : 100 %
Air Velocity : 2 m/s

1.2V

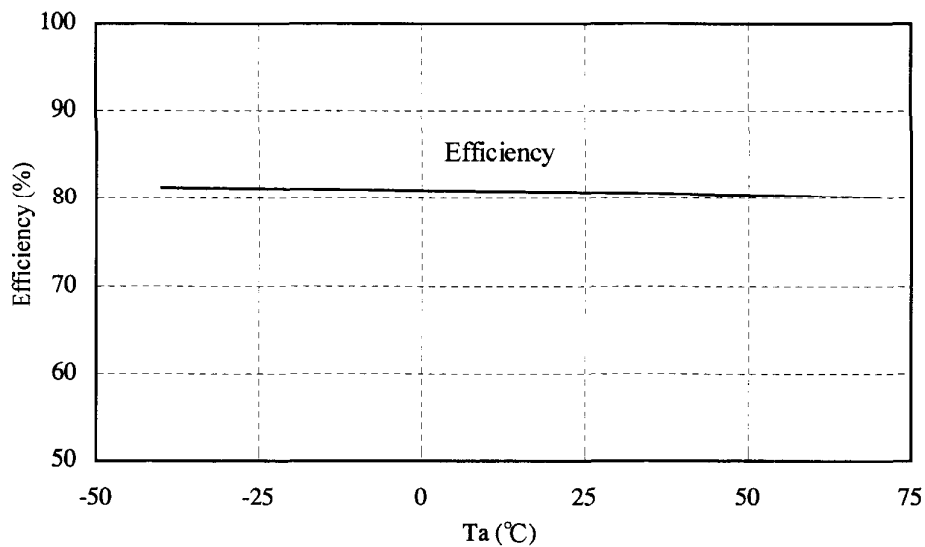

1.8V

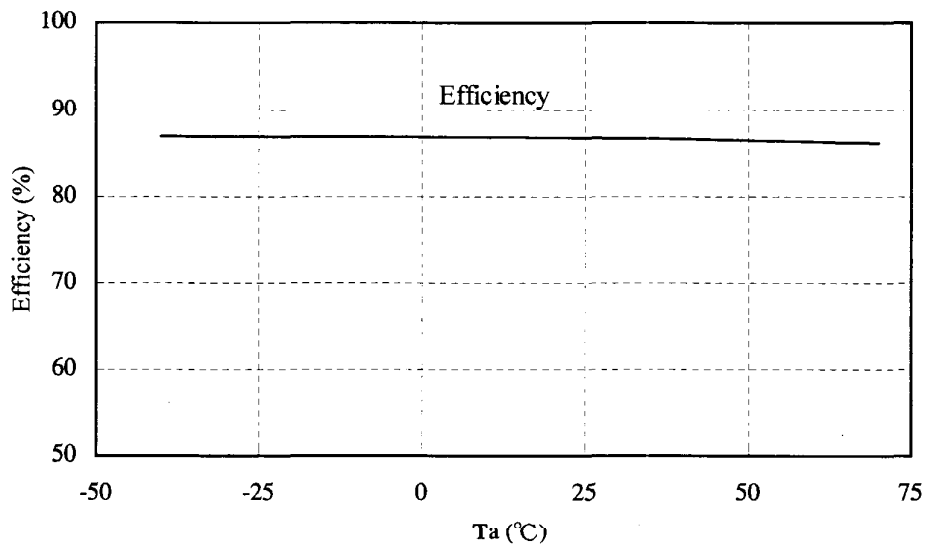

2.1 (5) 効率が周囲温度
Efficiency vs ambient temperature

Conditions Vin : 48 VDC
Iout : 100 %
Air Velocity : 2 m/s

2.5V

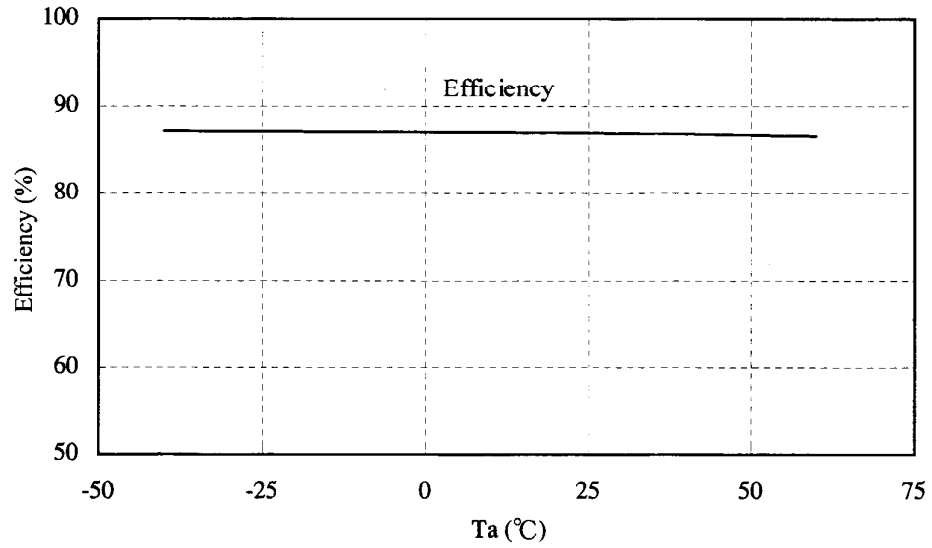

3.3V

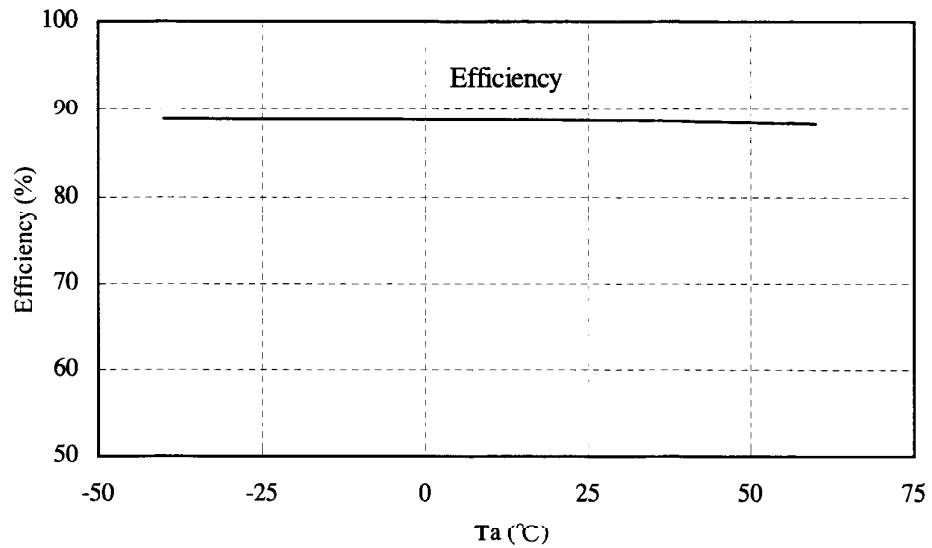

2.1 (5) 効率対周囲温度
Efficiency vs ambient temperature

Conditions Vin : 48 VDC
Iout : 100 %
Air Velocity : 2 m/s

5V

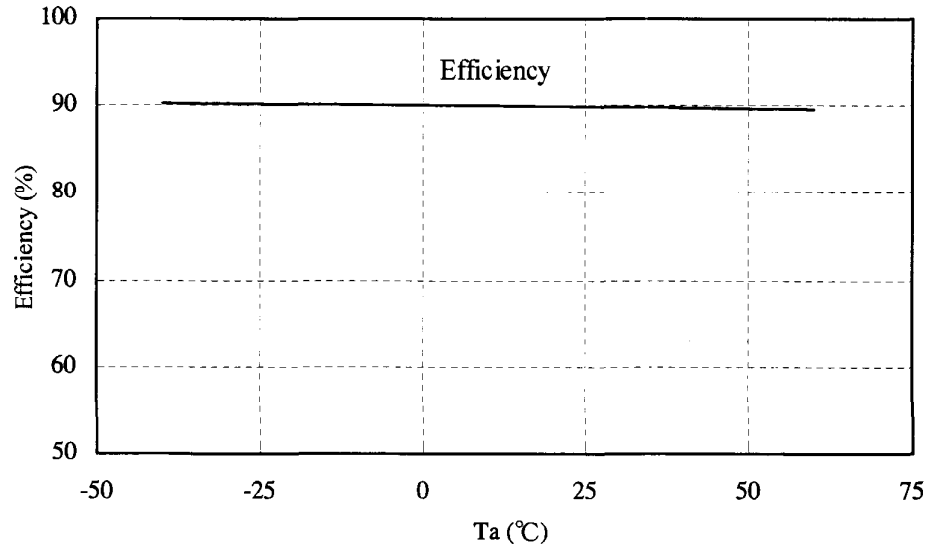

2.2 通電ドリフト特性
Warm up voltage drift characteristics

Conditions Vin : 48 VDC
Iout : 100 %
Ta : 25 °C
Air Velocity : 2 m/s

1.8V

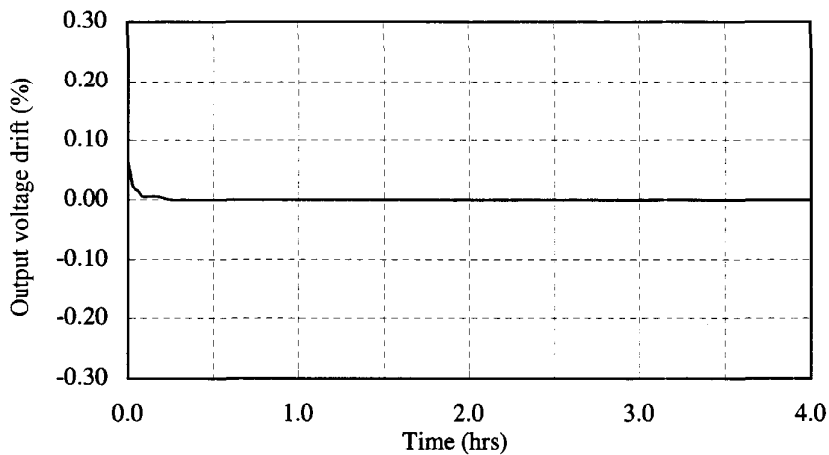

3.3V

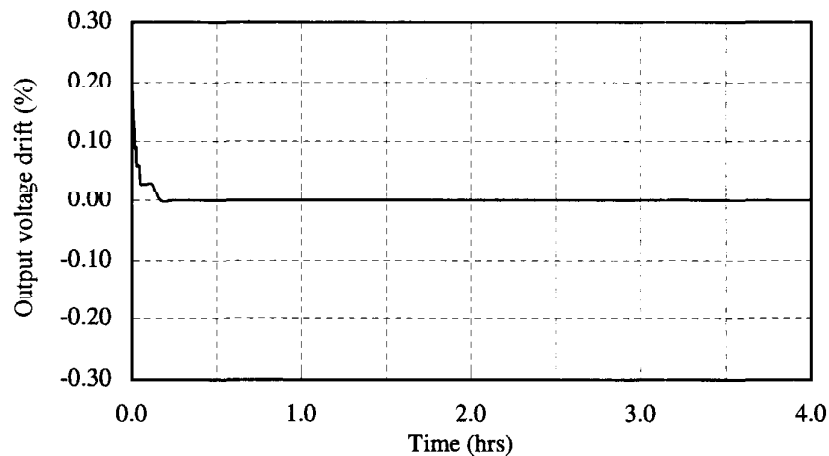

5V

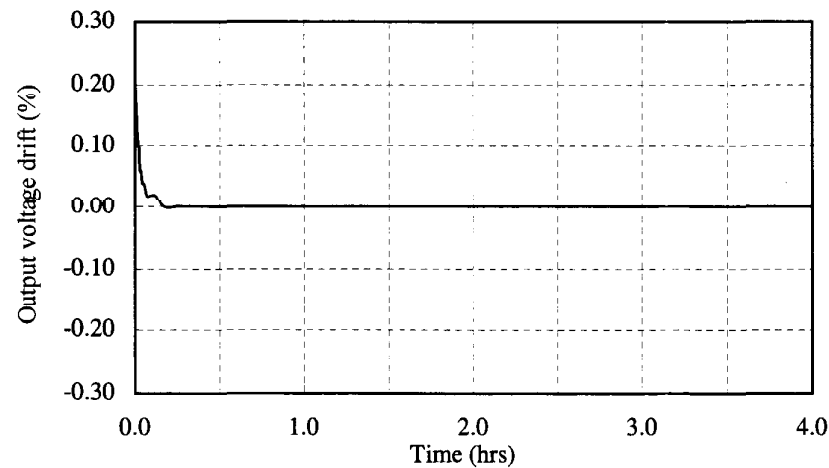

2.3 過電流保護特性
Over current protection (OCP) characteristics

Conditions Vin : 36 VDC -----
 : 48 VDC - - - - -
 : 76 VDC ————
 Ta : 25 °C

1.8V

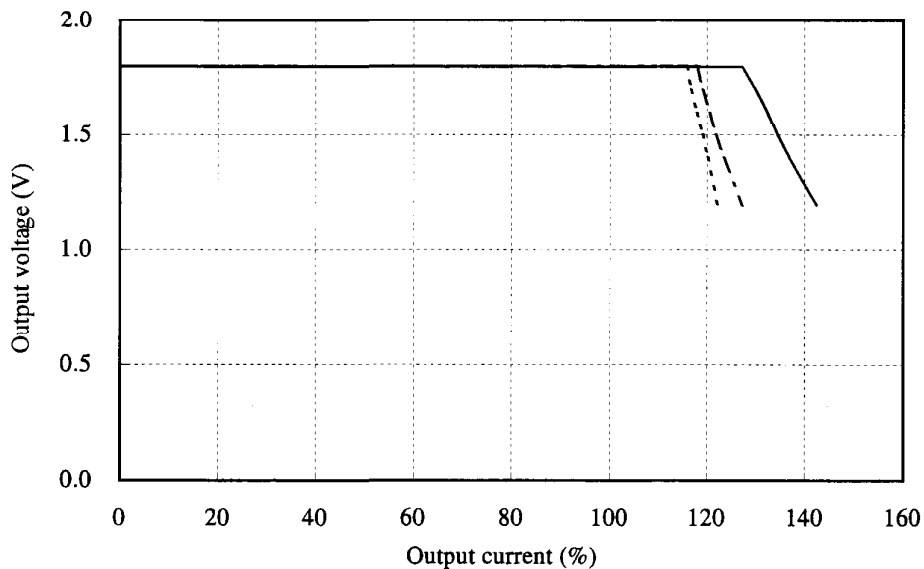

3.3V

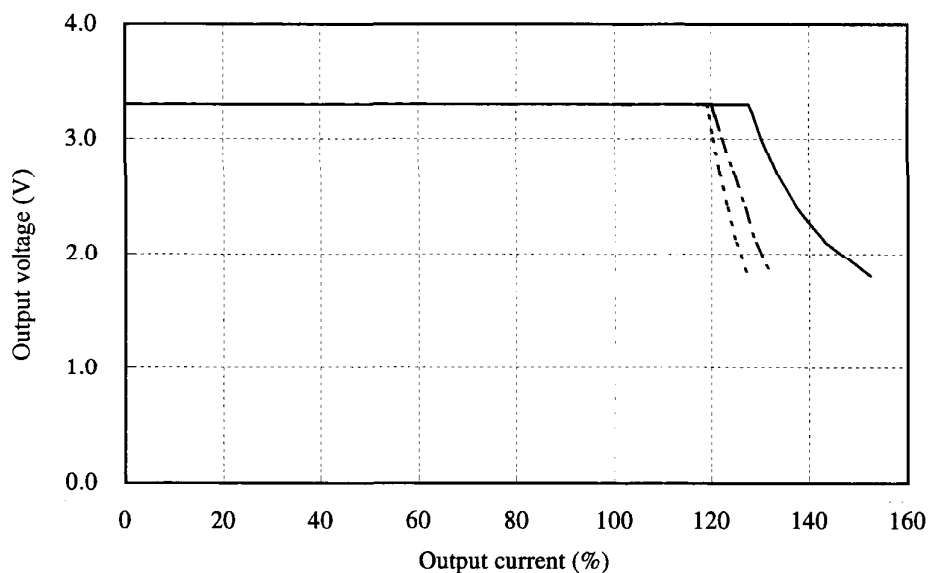

2.3 過電流保護特性

Over current protection (OCP) characteristics

Conditions Vin : 36 VDC -----
 : 48 VDC -.-.-.-.-
 : 76 VDC —————
Ta : 25 °C

5V

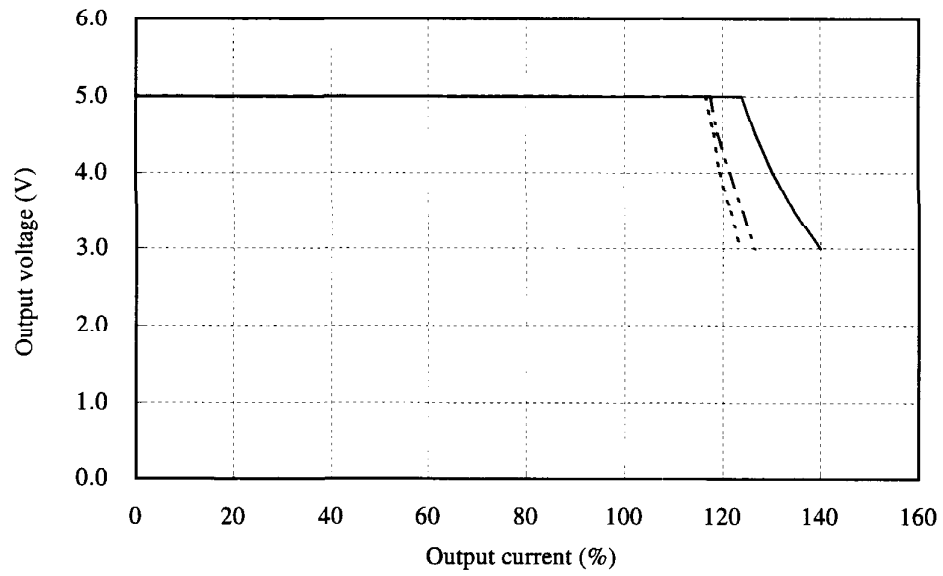

2.3 過電流保護特性
Over current protection (OCP) characteristics

Conditions Ta : -40 °C -----
 : 25 °C -.-.-.-
 : 70 °C _____
 Vin: 48 VDC

1.8V

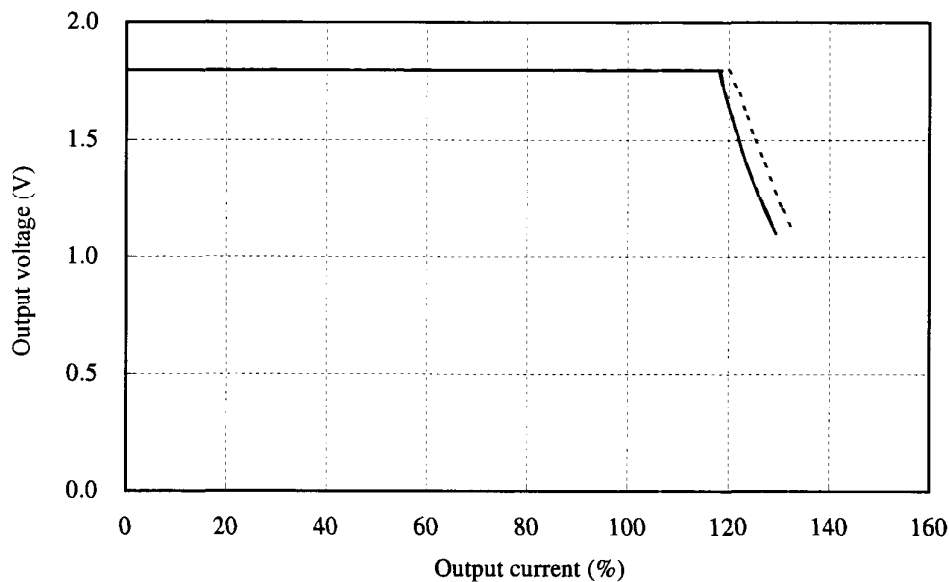

Conditions Ta : -40 °C -----
 : 25 °C -.-.-.-
 : 60 °C _____
 Vin: 48 VDC

3.3V

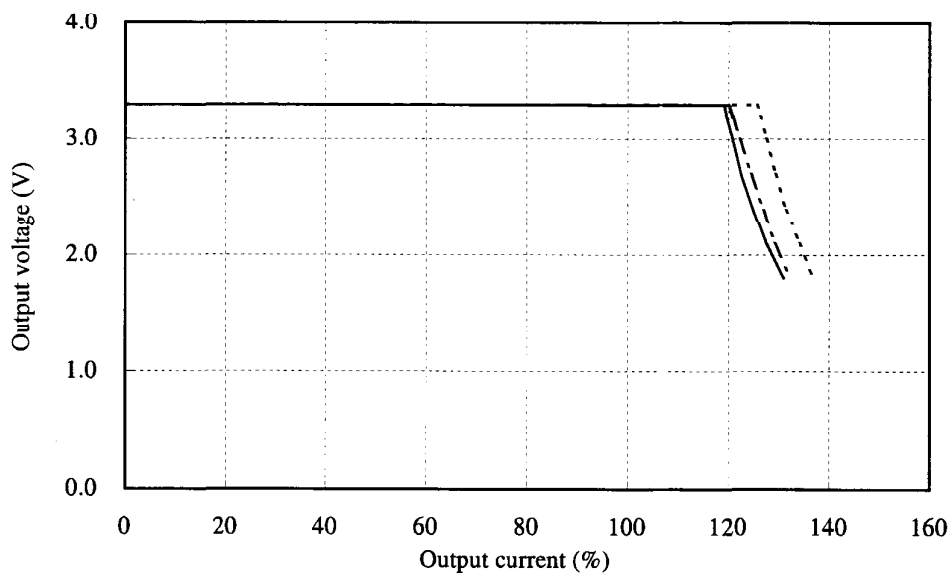

2.3 過電流保護特性
Over current protection (OCP) characteristics

Conditions Ta : -40 °C -----
 : 25 °C - · - · -
 : 60 °C —————
Vin : 48 VDC

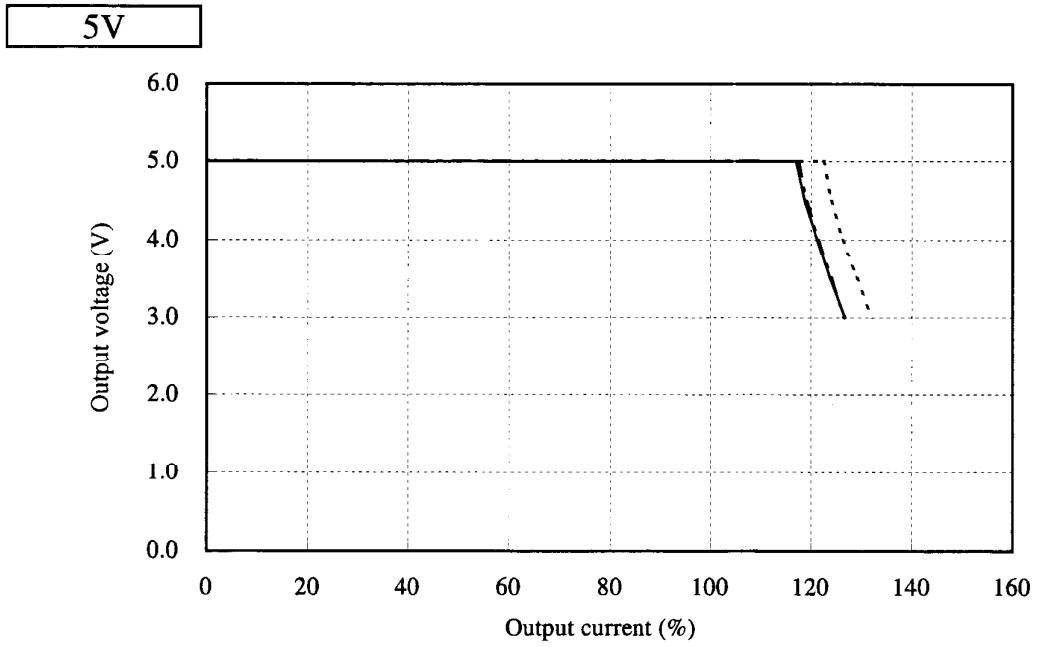

2.4 過電圧保護特性
Over voltage protection (OVP) characteristics

Conditions V_{in} : 48 VDC
 I_{out} : 0 %
 T_a : 25 °C

1.8V

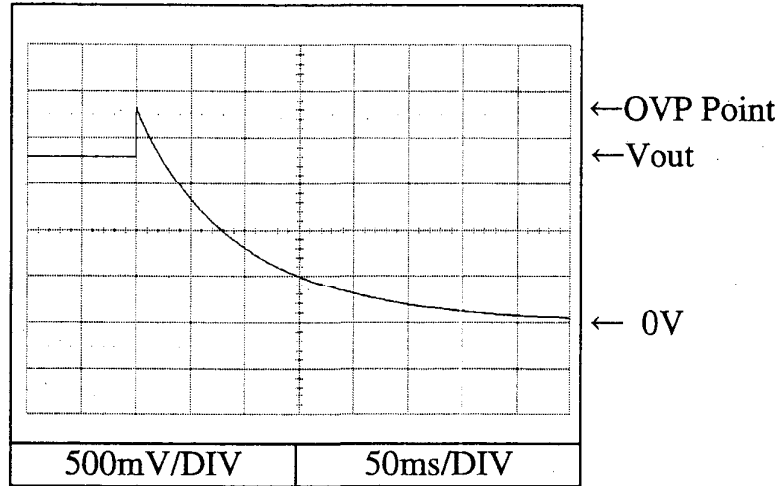

3.3V

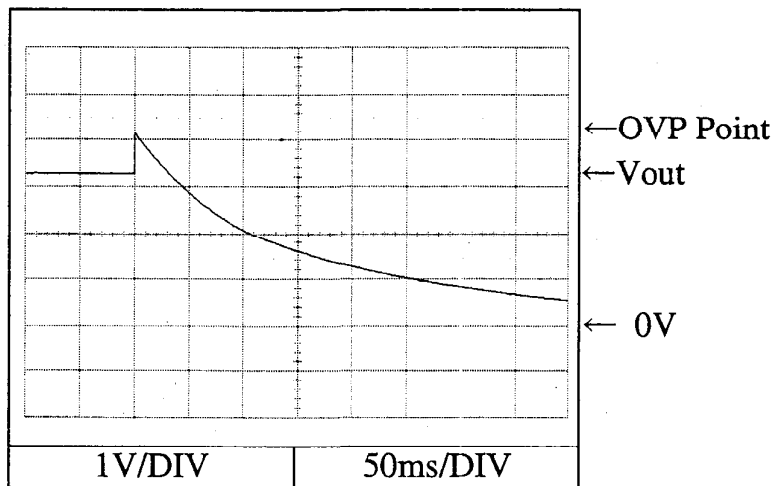

5V

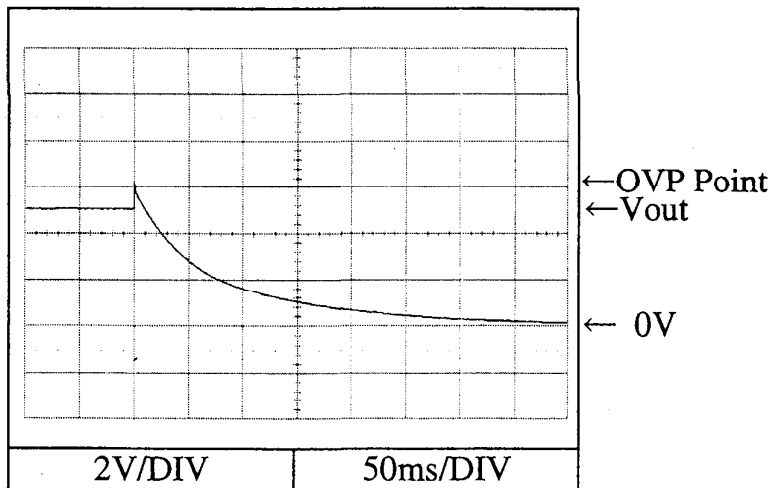

2.5 出力立ち上がり特性
Output rise characteristics

PAQ100S48-*

Conditions Vin : 48 VDC
Iout : 0 %
Ta : 25 °C

1.8V

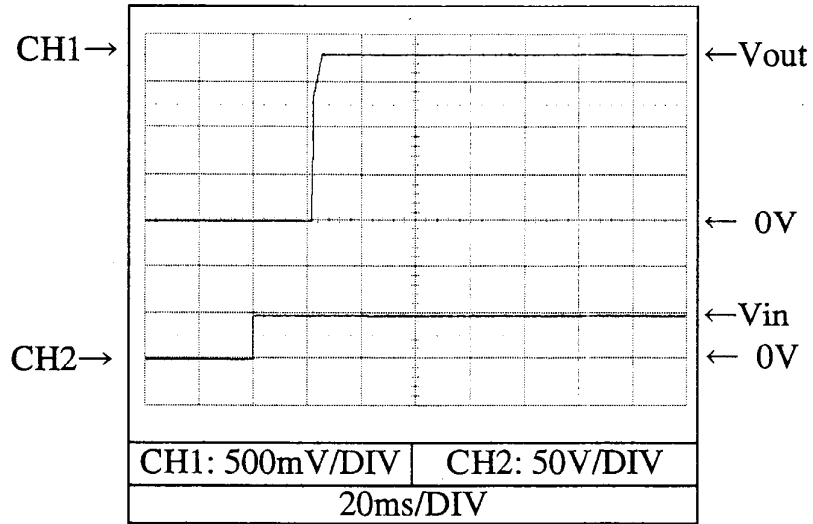

3.3V

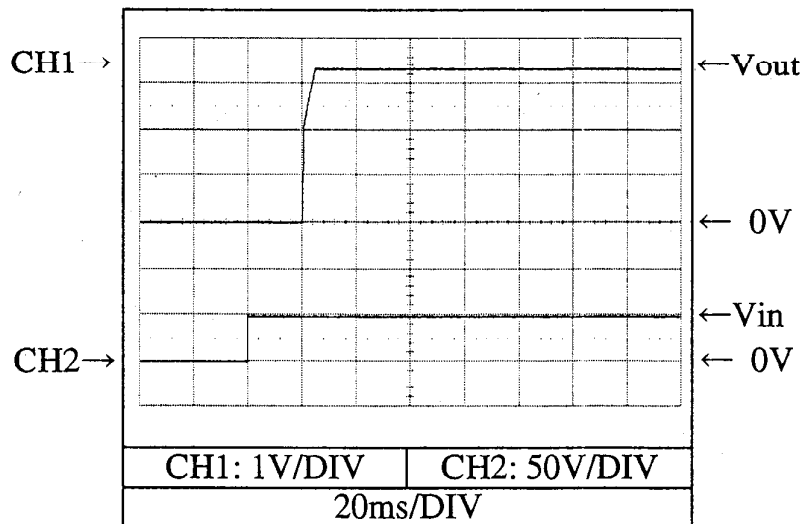

5V

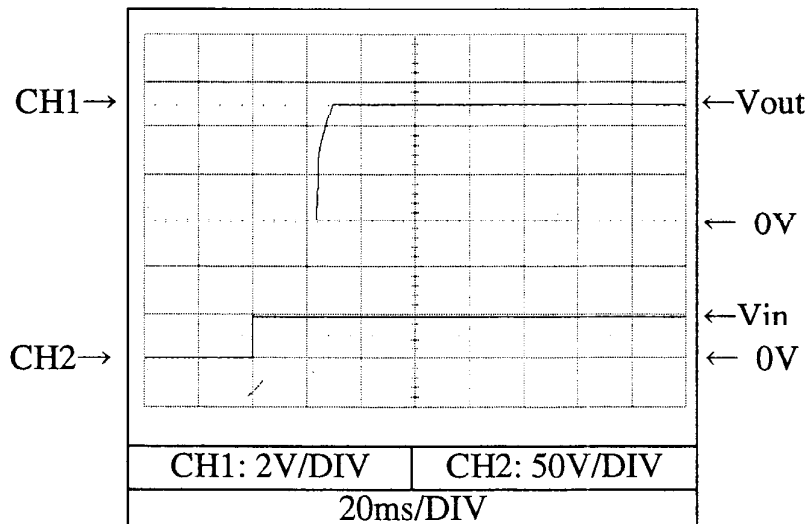

出力立ち上がり特性
Output rise characteristics

PAQ100S48-*

Conditions Vin : 48 VDC
Iout : 100 %
Ta : 25 °C

1.8V

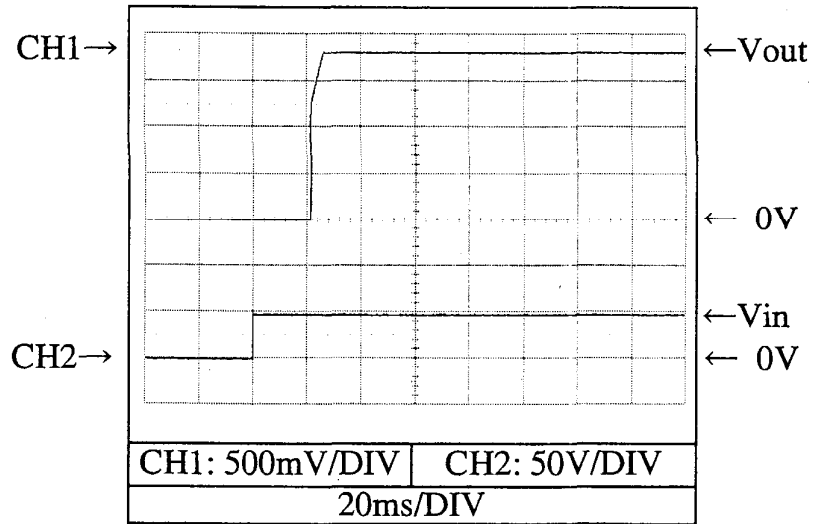

3.3V

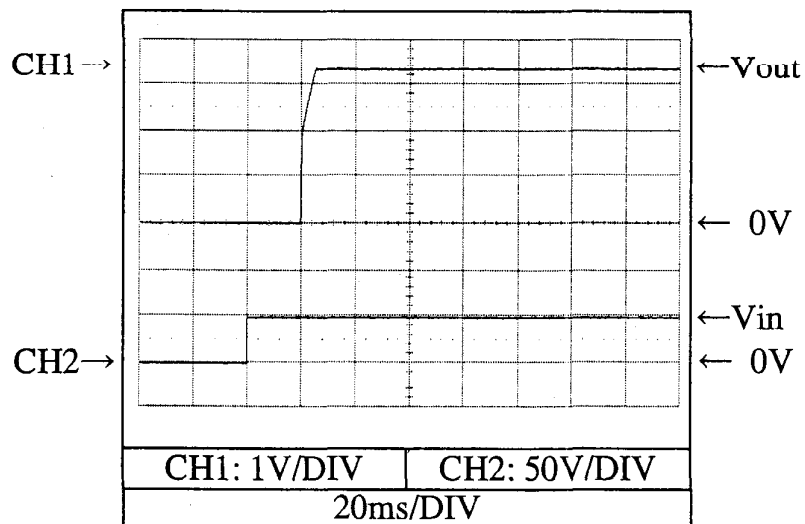

5V

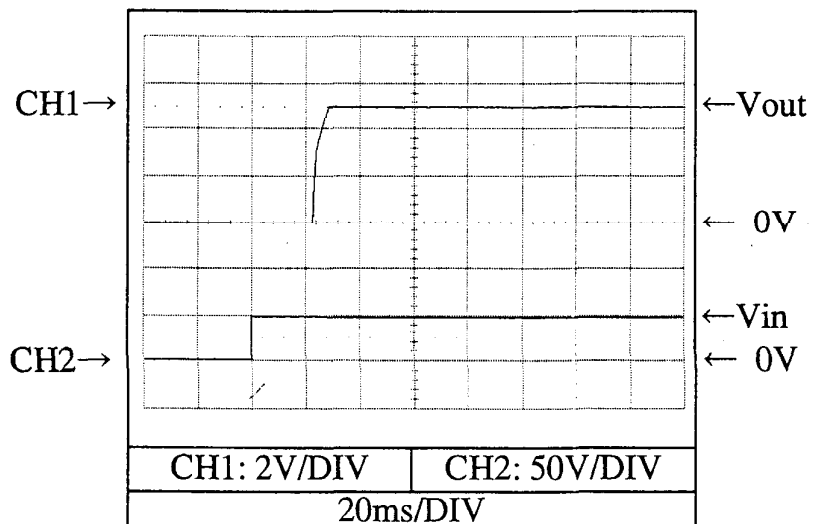

2.6 出力立ち下がり特性
Output fall characteristics

PAQ100S48-*

Conditions Vin : 48 VDC
Iout : 0 %
Ta : 25 °C

1.8V

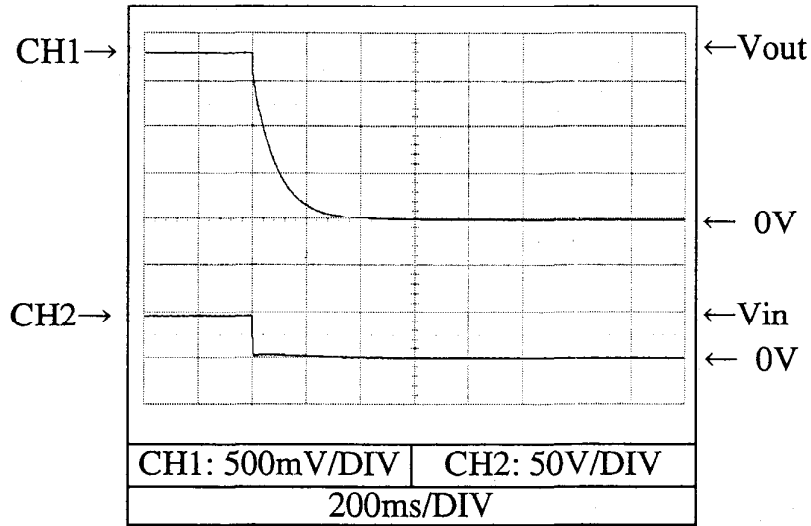

3.3V

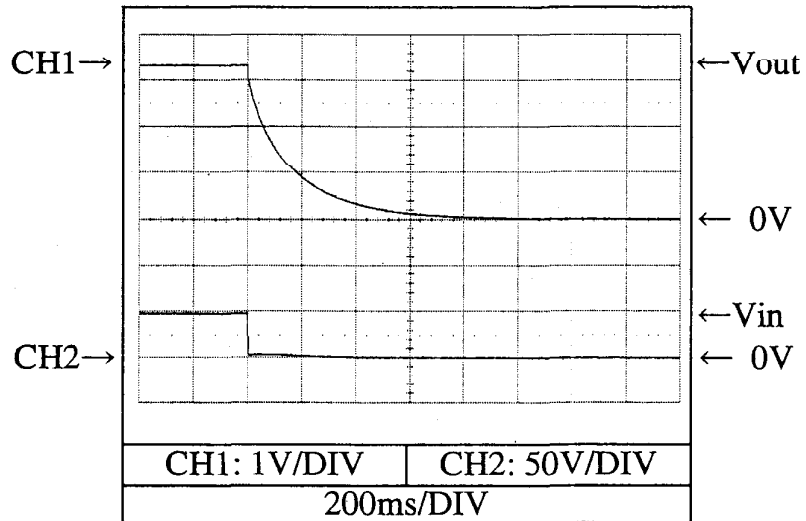

5V

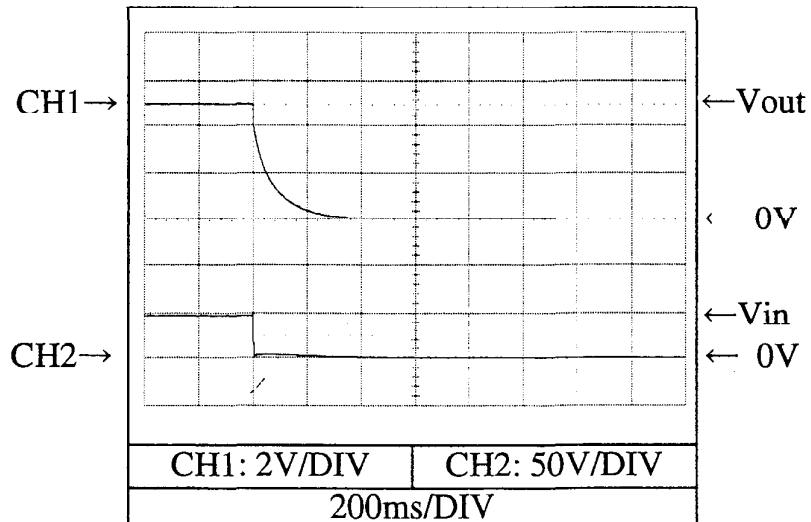

出力立ち下がり特性
Output fall characteristics

PAQ100S48-*

Conditions Vin : 48 VDC
Iout : 100 %
Ta : 25 °C

1.8V

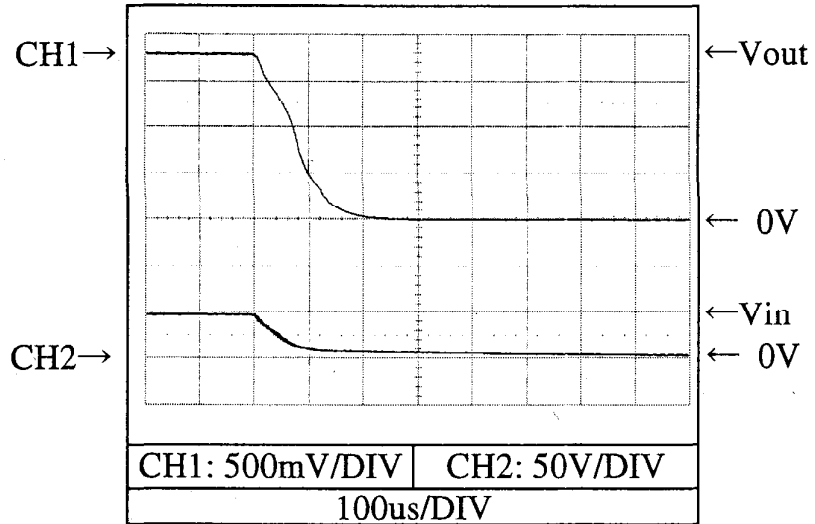

3.3V

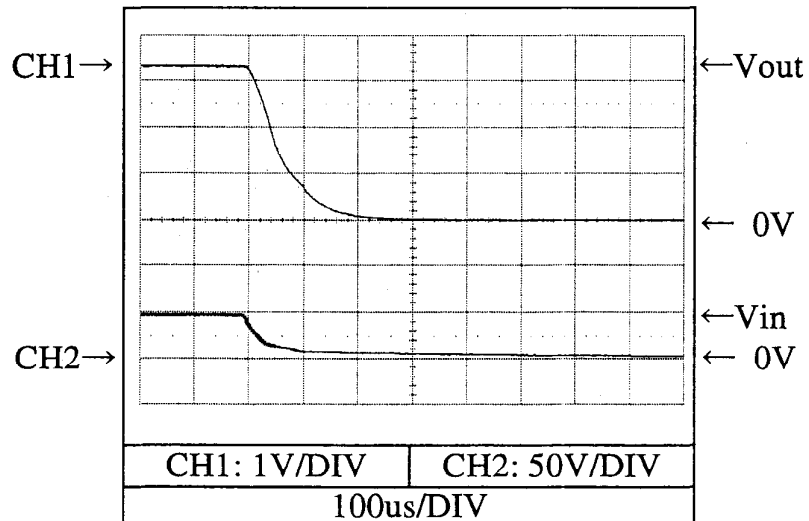

5V

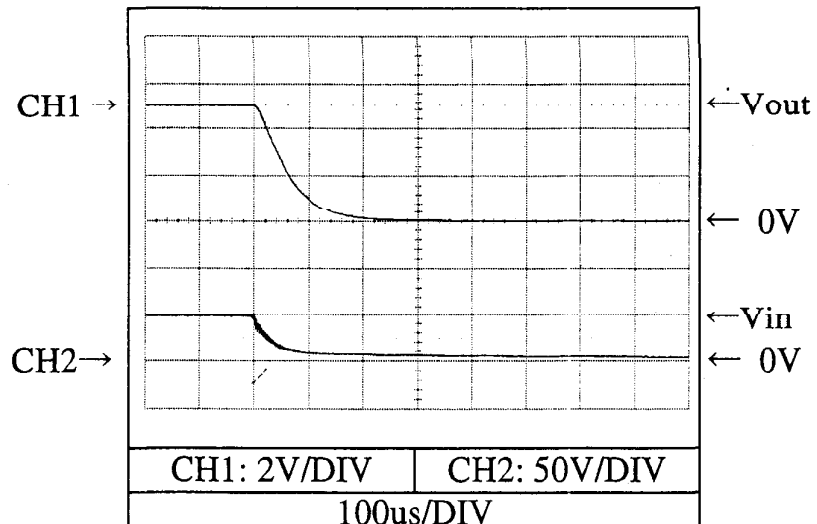

2.7 出力立ち上がり特性 (ON/OFFコントロール時)
Output rise characteristics with ON/OFF CONTROL

PAQ100S48-*

Conditions Vin : 48 VDC
Iout : 0 %
Ta : 25 °C

1.8V

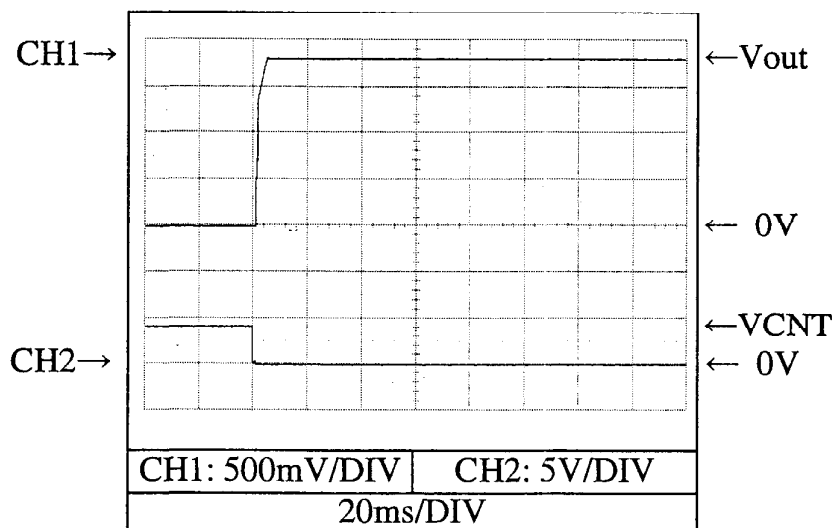

3.3V

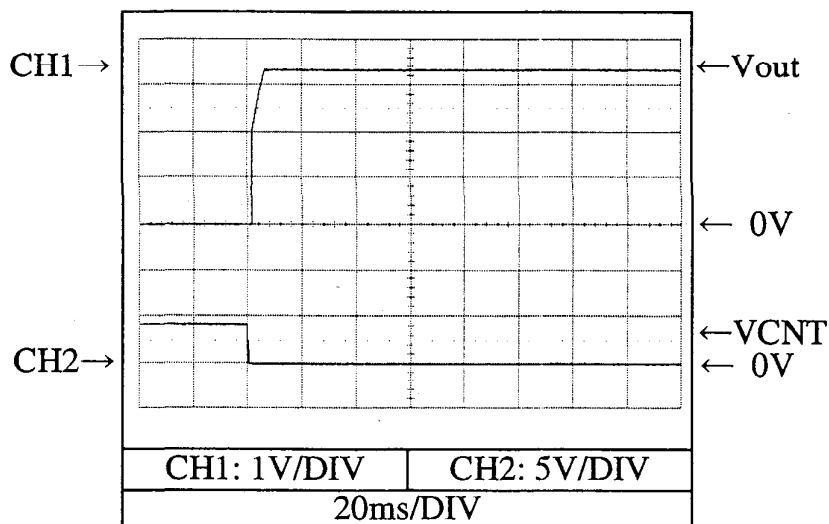

5V

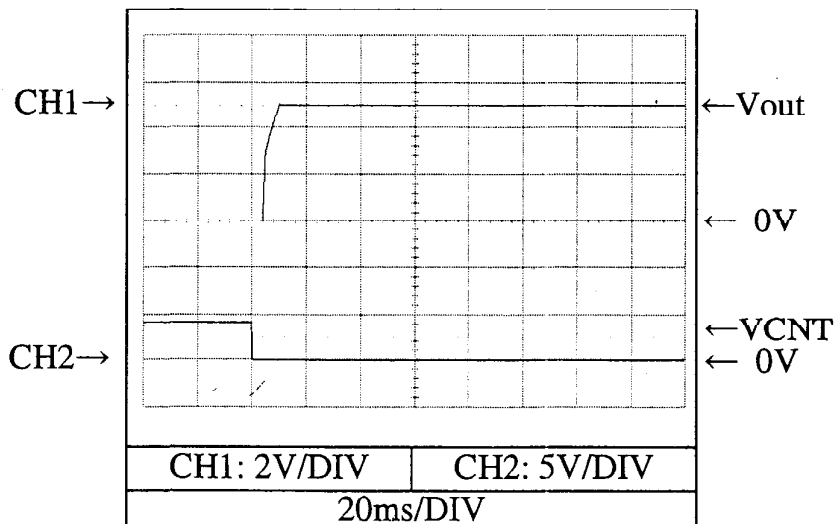

出力立ち上がり特性 (ON/OFFコントロール時)
Output rise characteristics with ON/OFF CONTROL

PAQ100S48-*

Conditions Vin : 48 VDC
Iout : 100 %
Ta : 25 °C

1.8V

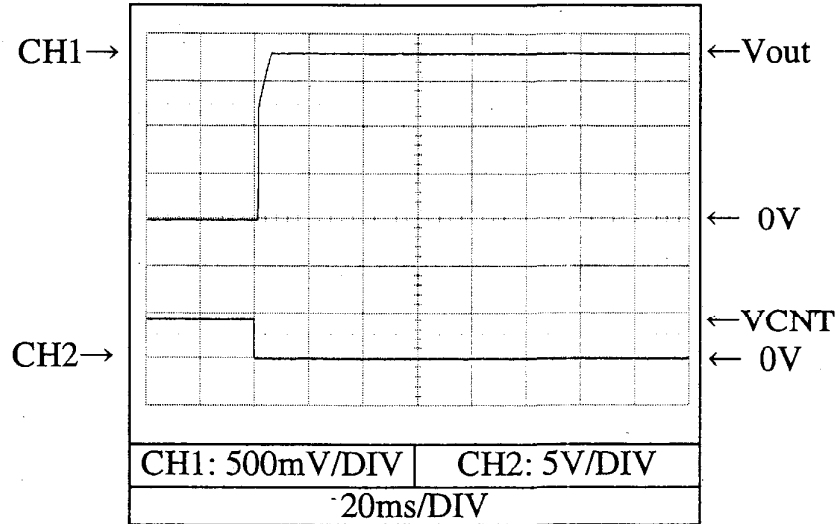

3.3V

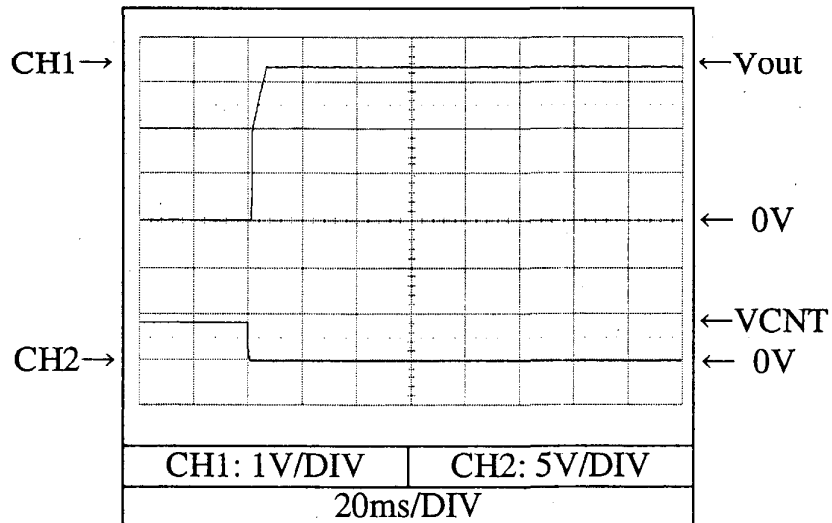

5V

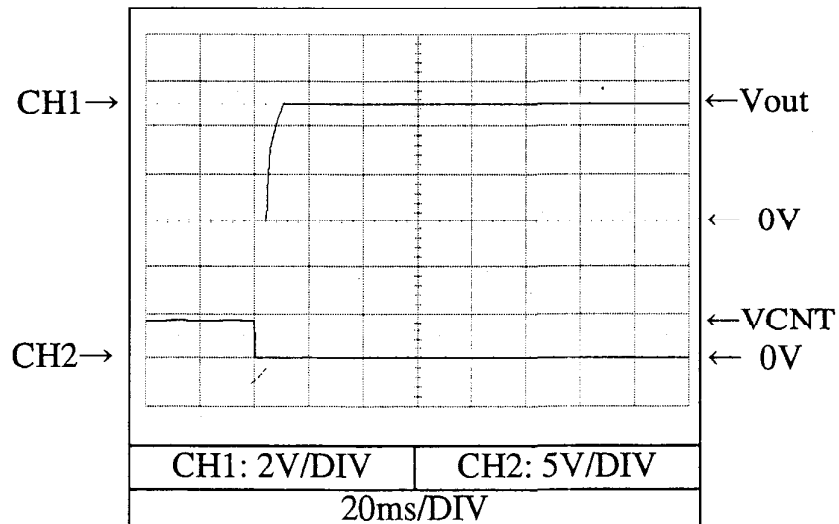

2.8 出力立ち下がり特性 (ON/OFFコントロール時)
Output fall characteristics with ON/OFF CONTROL

PAQ100S48-*

Conditions Vin : 48 VDC
Iout : 0 %
Ta : 25 °C

1.8V

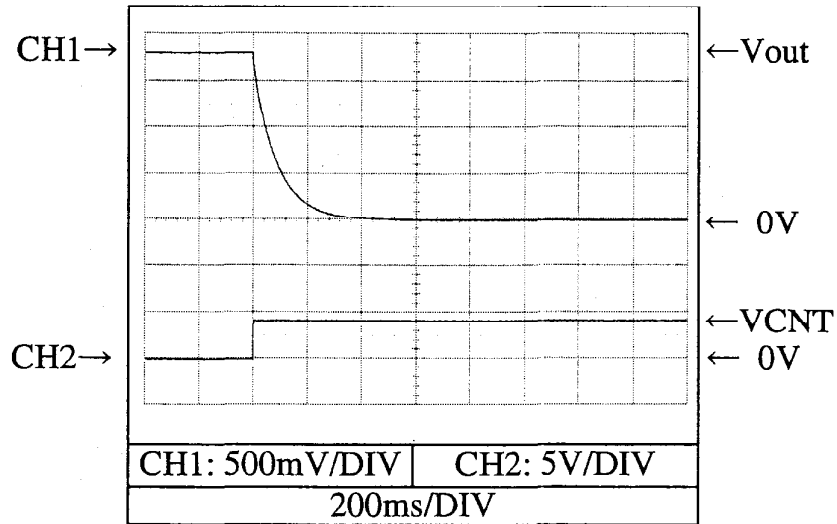

3.3V

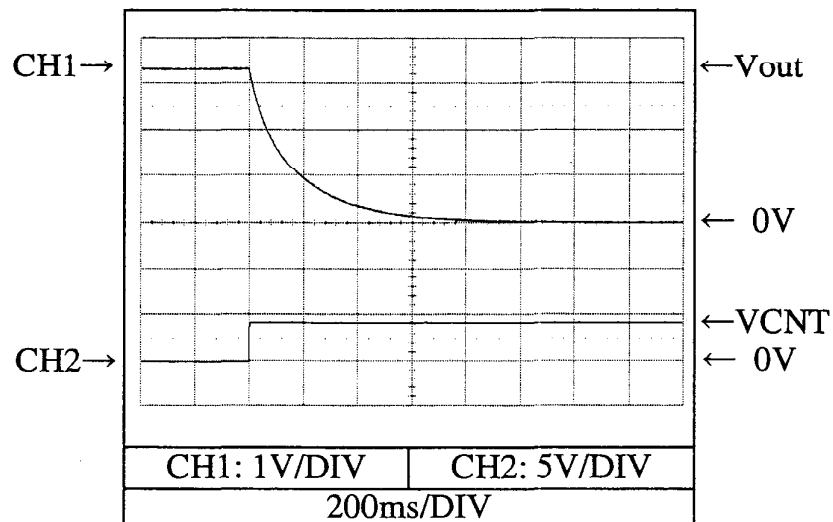

5V

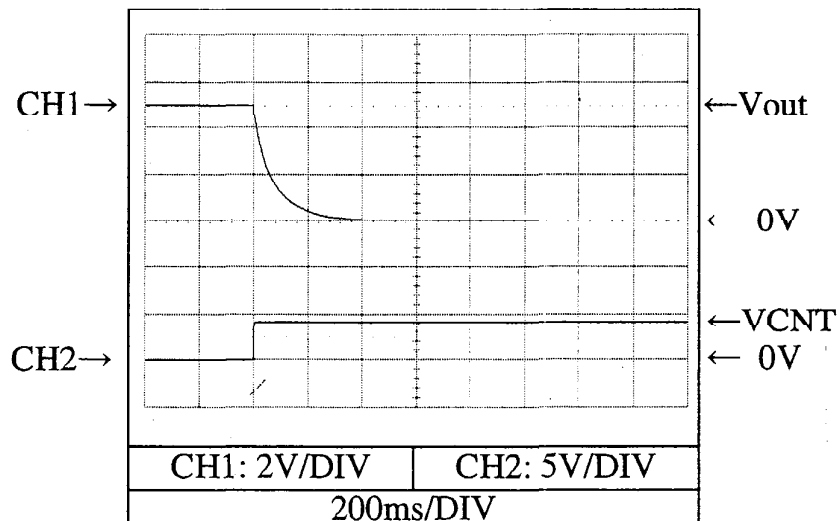

出力立ち下がり特性 (ON/OFFコントロール時)
Output fall characteristics with ON/OFF CONTROL

Conditions Vin : 48 VDC
Iout : 100 %
Ta : 25 °C

1.8V

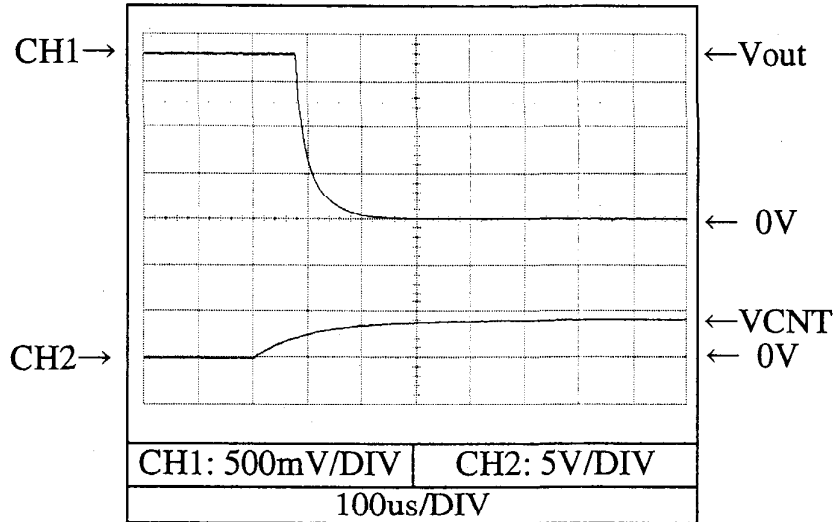

3.3V

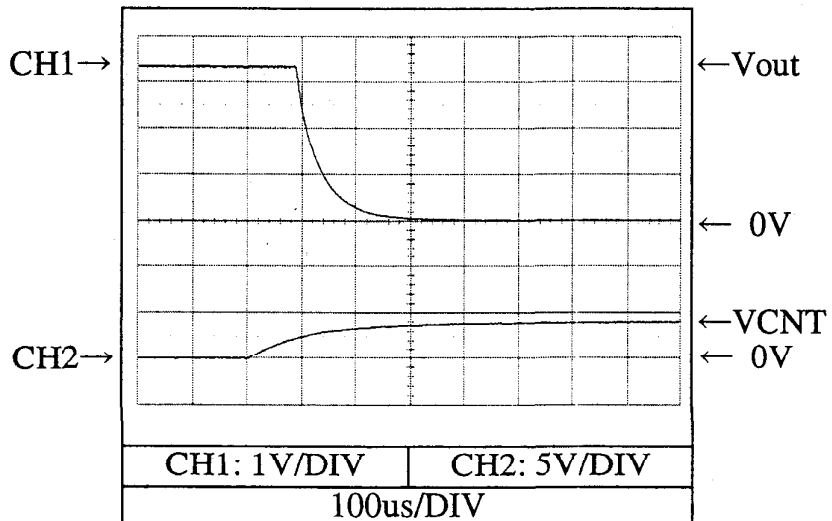

5V

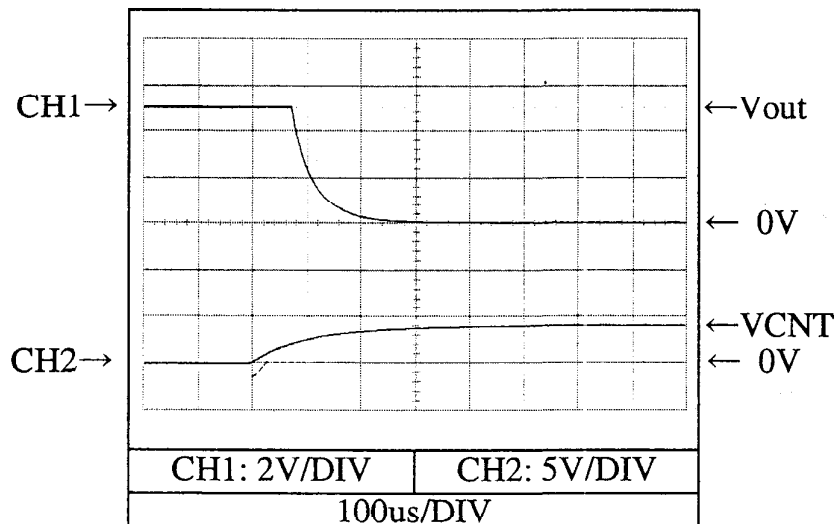

2.9 過渡応答（負荷急変）特性
Dynamic load response characteristics

Conditions Vin : 48 VDC
Ta : 25 °C

1.8V

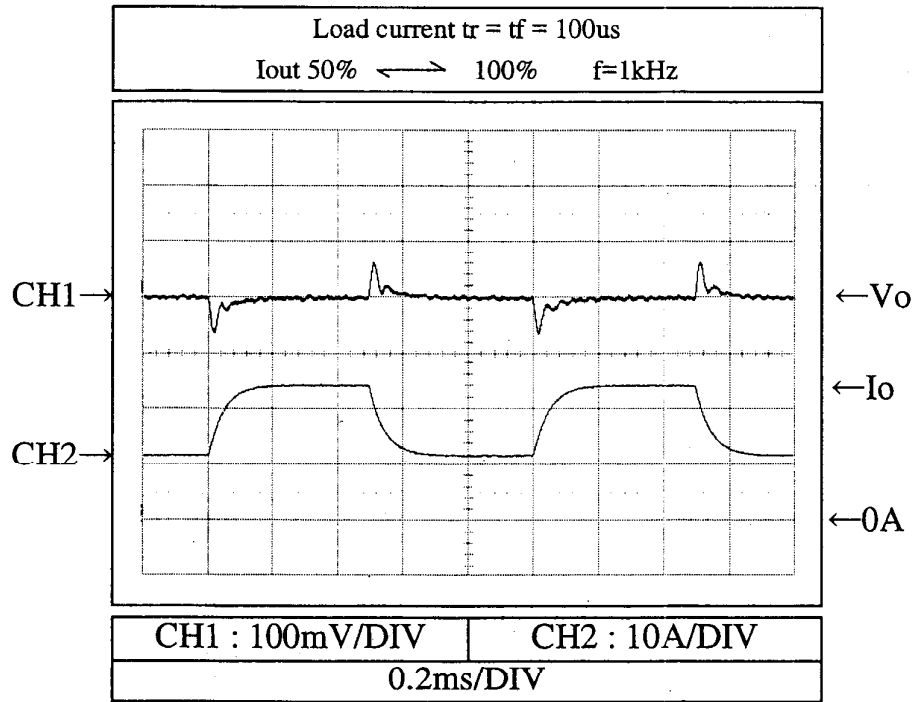

3.3V

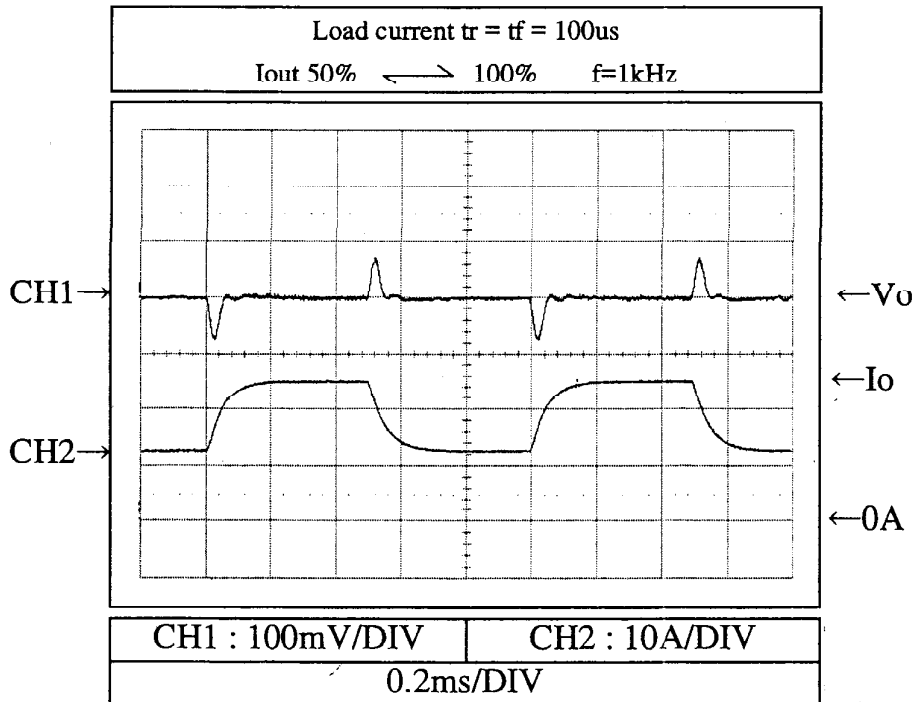

2.9 過渡応答 (負荷急変) 特性
 Dynamic load response characteristics

Conditions V_{in} : 48 VDC
 T_a : 25 °C

5V

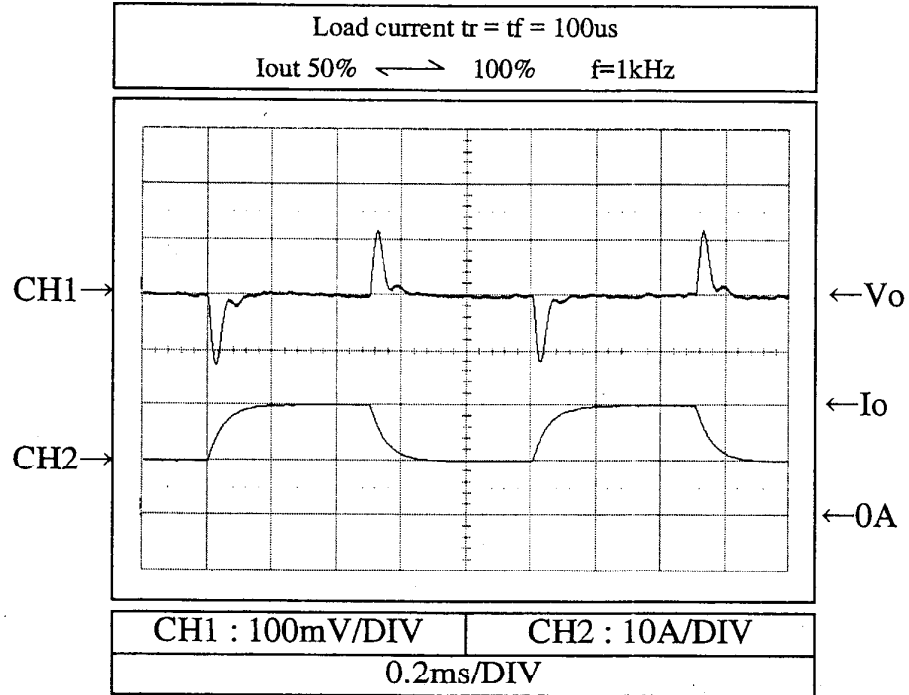

2.10 入力サージ電流 (突入電流) 特性
Inrush current waveform

Conditions Vin : 48 VDC
Iout : 100 %
Ta : 25 °C

3.3V

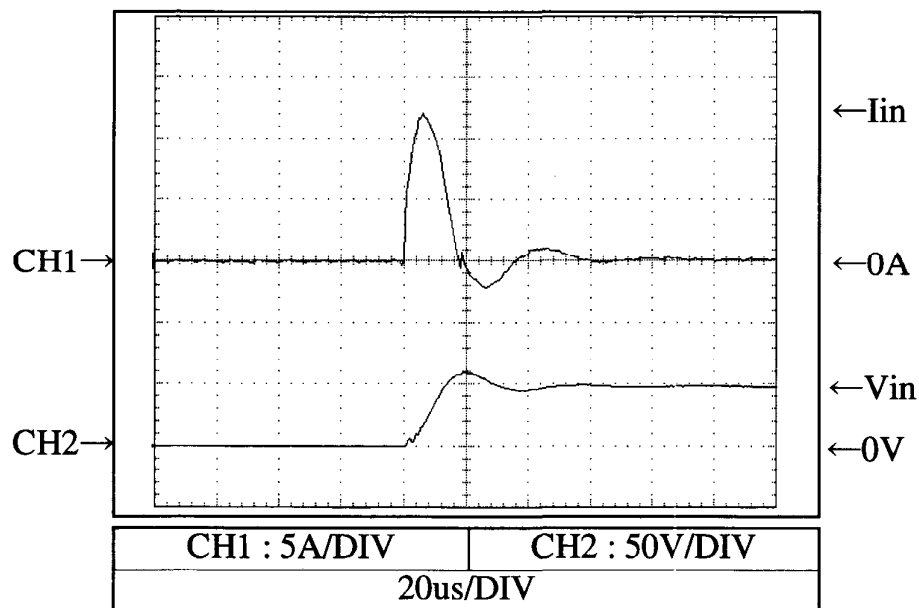

2.11 出力リップル、ノイズ波形
Output ripple and noise waveform

PAQ100S48-*

Conditions Vin : 48 VDC

Iout : 100 %

Ta : 25 °C

1.8V

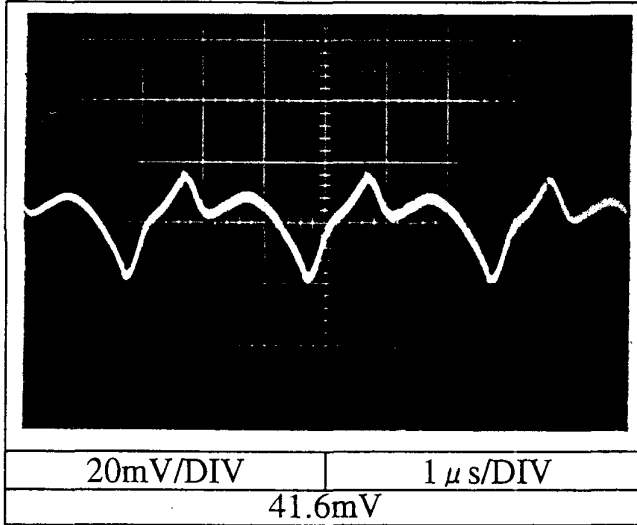

3.3V

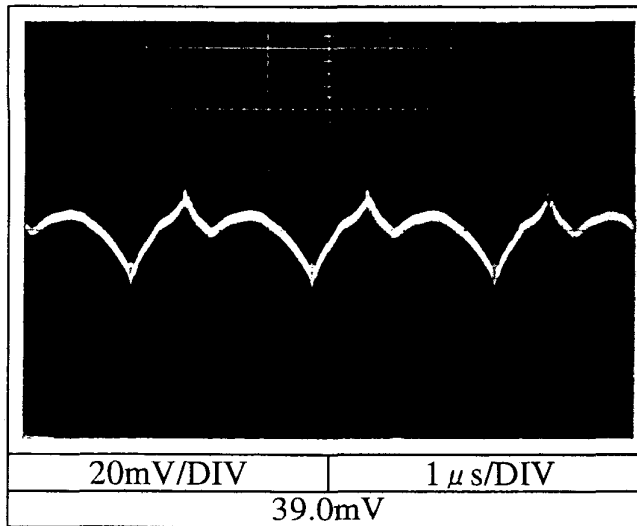

5V

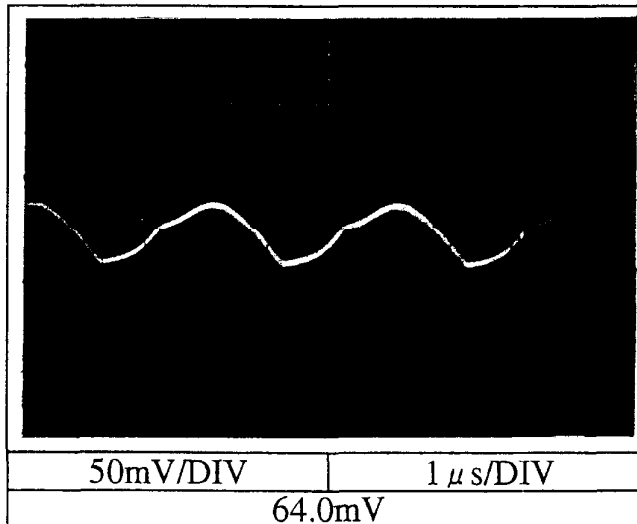

2.12 EMI特性

Electro-Magnetic Interference characteristics

(a) 雑音端子電圧 (帰還ノイズ)

Conditions Vin : 48 VDC

Conducted Emission

Iout : 100 %

(1) VCCI class A 対応アプリケーションシステム

Ta : 25 °C

VCCI class A application system

1.8V

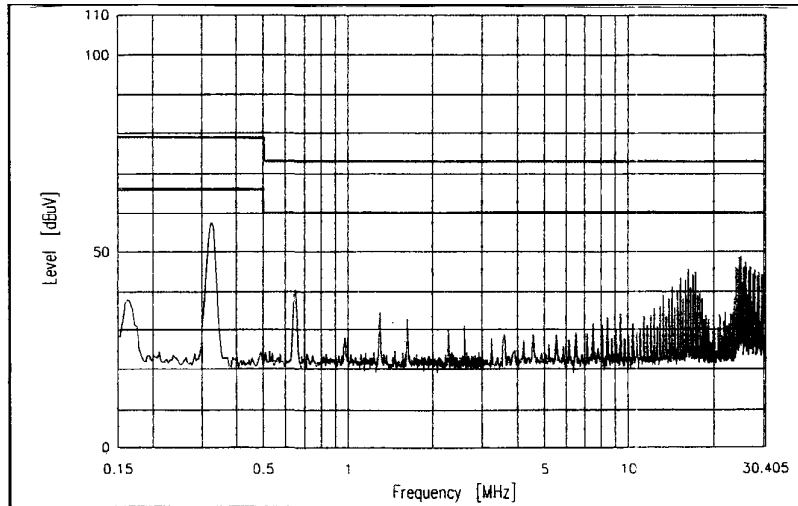

3.3V

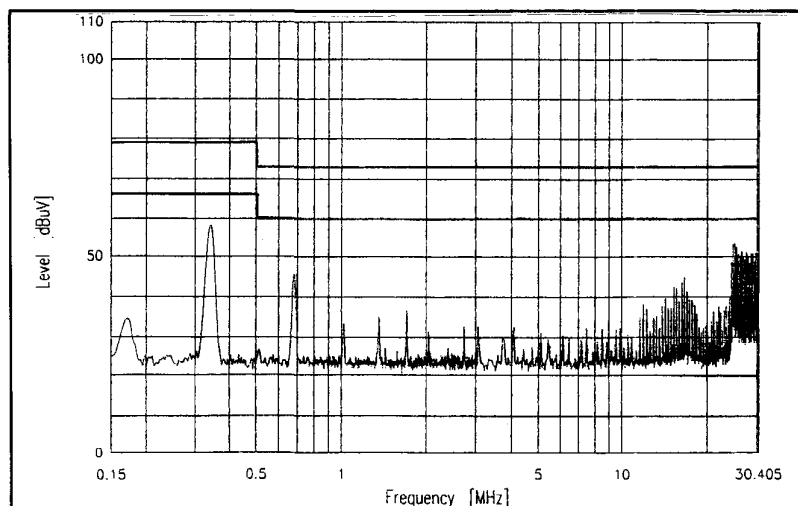

FMT特性

Electro-Magnetic Interference characteristics

(a) 雑音端子電圧 (帰還ノイズ)

Conditions Vin : 48 VDC

Conducted Emission

Iout : 100 %

(1) VCCI class A 対応アプリケーションシステム

Ta : 25 °C

VCCI class A application system

5V

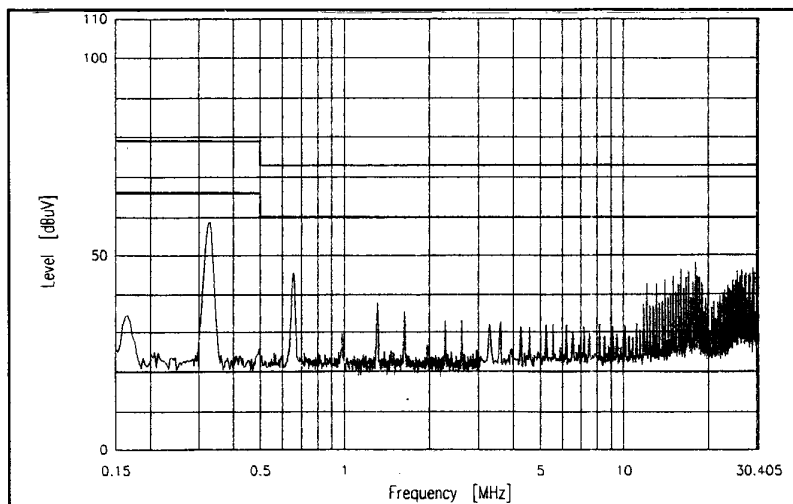

EMI特性

Electro-Magnetic Interference characteristics

(b) 雑音電界強度 (輻射ノイズ)

Radiated Emission

(1) VCCI class A 対応アプリケーションシステム

VCCI class A application system

Conditions Vin : 48 VDC

Iout : 100 %

Ta : 25 °C

1.8V

HORIZONTAL:

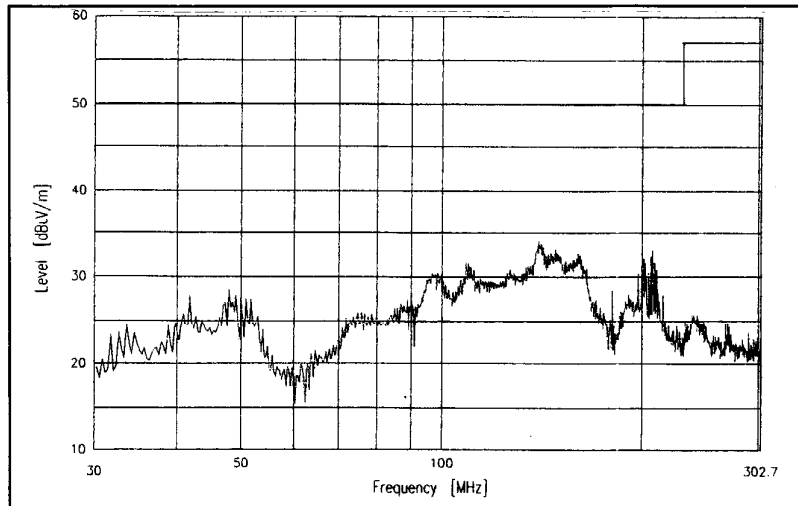

VERTICAL:

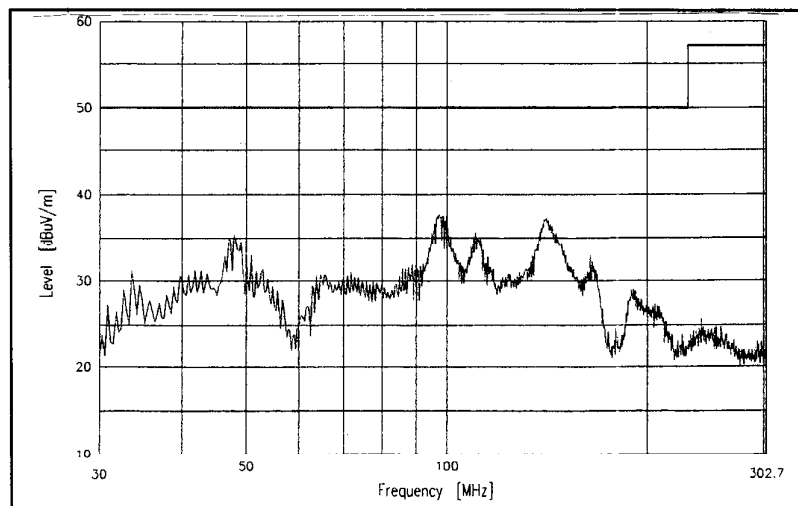

EMI特性

Electro-Magnetic Interference characteristics

(b) 雑音電界強度 (輻射ノイズ)

Conditions Vin : 48 VDC

Radiated Emission

Iout : 100 %

(1) VCCI class A 対応アプリケーションシステム

Ta : 25 °C

VCCI class A application system

3.3V

HORIZONTAL:

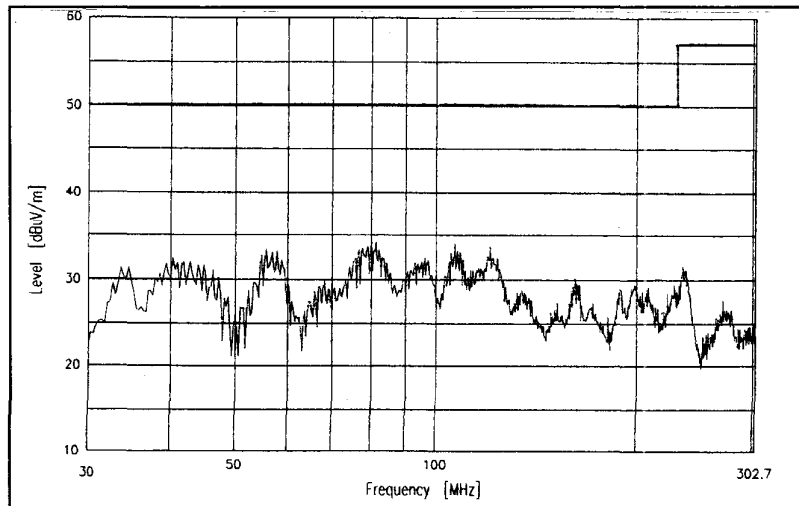

VERTICAL:

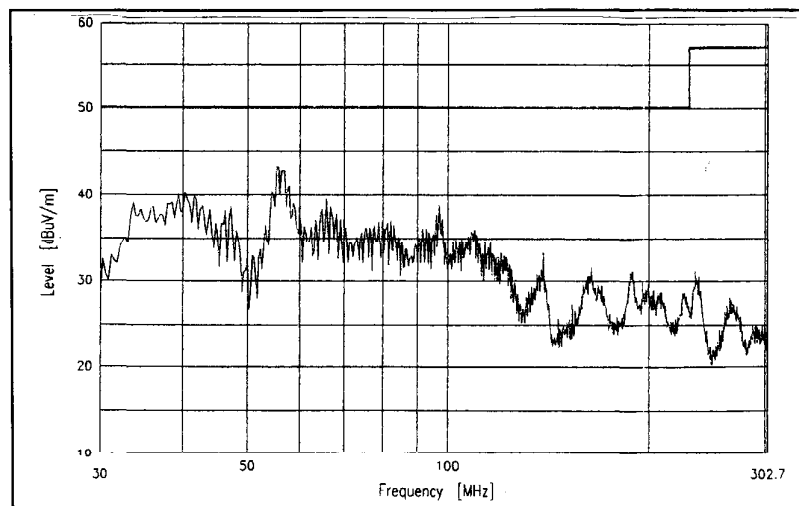

EMT特性

Electro-Magnetic Interference characteristics

(b) 雑音電界強度 (輻射ノイズ)

Radiated Emission

(1) VCCI class A 対応アプリケーションシステム

VCCI class A application system

Conditions Vin : 48 VDC

Iout : 100 %

Ta : 25 °C

5V

HORIZONTAL:

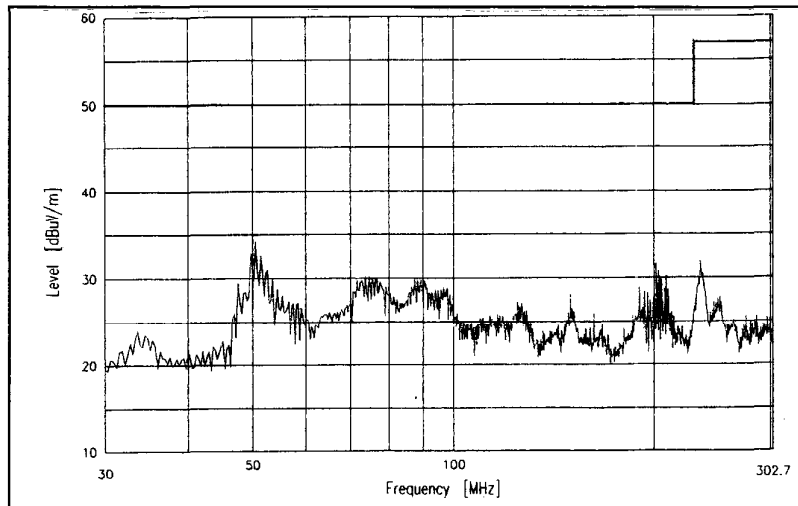

VERTICAL:

