

PSS1R5-5- *

EVALUATION DATA

型式データ

DWG.No. C180-53-01		
承認	査閲	担当
N. Uegono 27. Jan '05	S. Kamegama 27. Jan '05	H. Yasuda 27. Jan '05

DENSEI-LAMBDA

INDEX

1. 測定方法	Evaluation Method	PAGE
1.1	測定回路 Circuits used for determination	T-1~5
	(1) 静特性 Steady state data	
	(2) 通電ドリフト特性 Warm up voltage drift characteristics	
	(3) 過電流保護特性 Over current protection (OCP) characteristics	
	(4) 出力立ち上がり特性 Output rise characteristics	
	(5) 出力立ち下がり特性 Output fall characteristics	
	(6) 過渡応答 (負荷急変) 特性 Dynamic load response characteristics	
	(7) 入力サージ電流 (突入電流) 特性 Inrush current characteristics	
	(8) 出力リップル、ノイズ波形 Output ripple and noise waveform	
	(9) スイッチング周波数対出力電力 Switching frequency v.s. output power	
	(10) EMI特性 Electro-Magnetic Interference characteristics	
1.2	使用測定機器 List of equipments used	T-6
2.	特性データ Characteristics	
2.1	(1) 入力・負荷・温度変動	T-7~8
	(2) 出力電圧・リップル電圧対入力電圧 Output voltage and ripple voltage v.s. input voltage	T-9~10
	(3) 効率・入力電流対出力電流 Efficiency and input current v.s. output current	T-11~12
	(4) 効率対入力電圧 Efficiency v.s. input voltage	T-13~14
2.2	通電ドリフト特性 Warm up voltage drift characteristics	T-15
2.3	過電流保護特性 Over current protection (OCP) characteristics	T-16~17
2.4	出力立ち上がり特性 Output rise characteristics	T-18~19
2.5	出力立ち下がり特性 Output fall characteristics	T-20~21
2.6	過渡応答 (負荷急変) 特性 Dynamic load response characteristics	T-22~23
2.7	入力サージ電流 (突入電流) 特性 Inrush current waveform	T-24
2.8	出力リップル、ノイズ波形 Output ripple and noise waveform	T-25
2.9	スイッチング周波数対出力電力 Switching frequency v.s. output power	T-26
2.10	EMI特性 Electro-Magnetic Interference characteristics.....	T-27~28

使用記号 Terminology used

	Definition	
Vin	入力電圧 Input Voltage
Vout	出力電圧 Output Voltage
Iin	入力電流 Input Current
Iout	出力電流 Output Current
Ta	周囲温度 Ambient Temperature

1. 測定方法 Evaluation Method
 1.1 測定回路 Circuits used for determination
 (1) 静特性 Steady state data

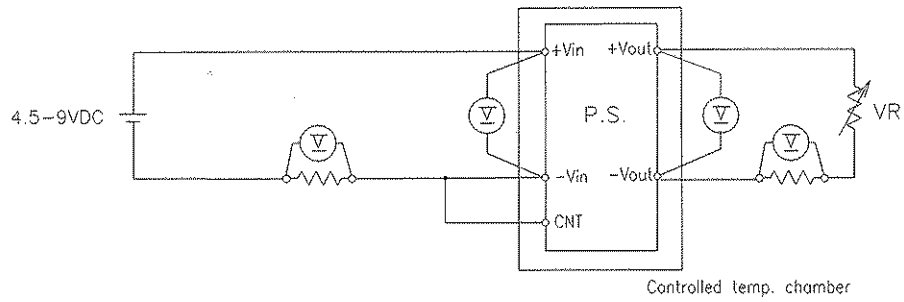

- (2) 通電ドリフト特性 Warm up voltage drift characteristics

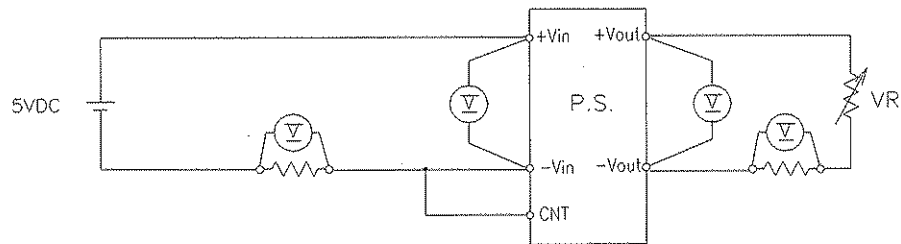

(3) 過電流保護特性 Over current protection (OCP) characteristics

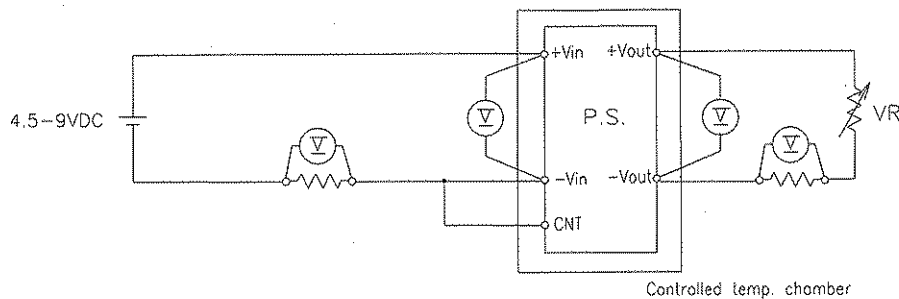

(4) 出力立ち上がり特性 Output rise characteristics

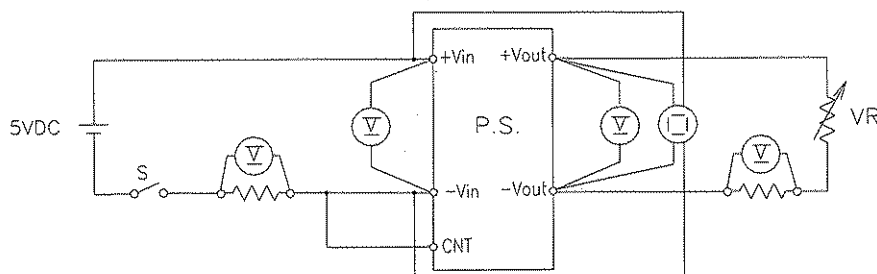

(5) 出力立ち下がり特性 Output fall characteristics

出力立ち上がり特性と同じ

Same as output rise characteristics

(6) 過渡応答(負荷急変)特性 Dynamic load response characteristics

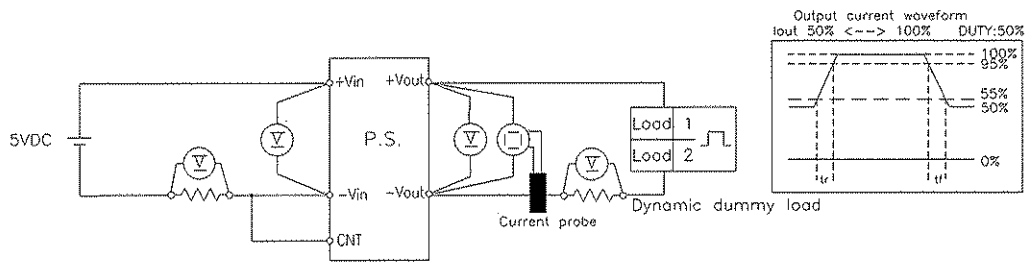

(7) 入力サージ電流(突入電流)特性 Inrush current characteristics

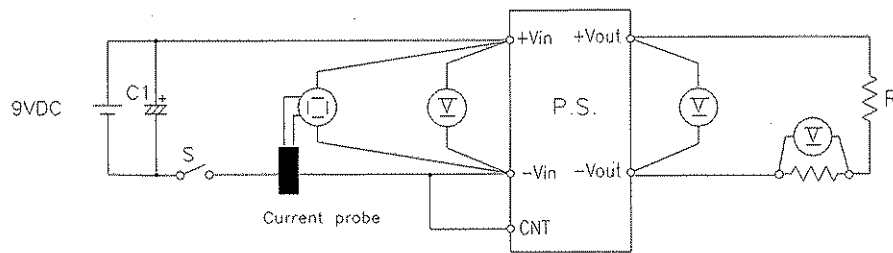

C1: 4000uF Electrolytic Capacitor

(8) 出力リップル、ノイズ波形 Output ripple and noise waveform

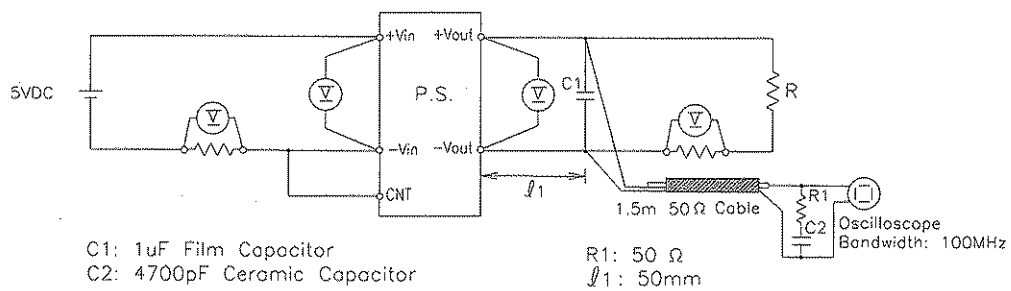

(9) スイッチング周波数対出力電力 Switching frequency v.s. output power

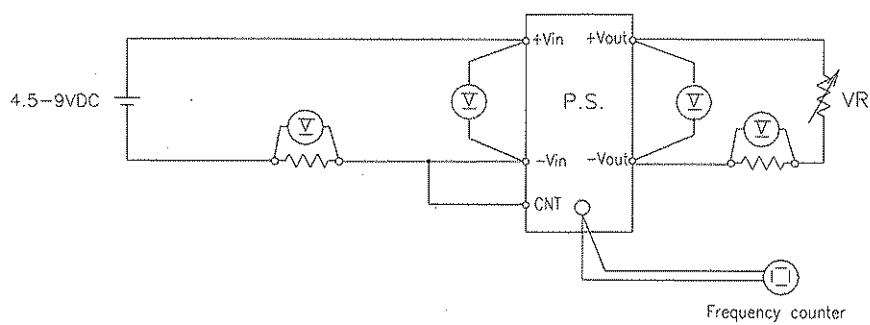

(10) EMI 特性 Electro-Magnetic Interference characteristics

(a) 雑音端子電圧 (帰還ノイズ) Conducted Emission Noise

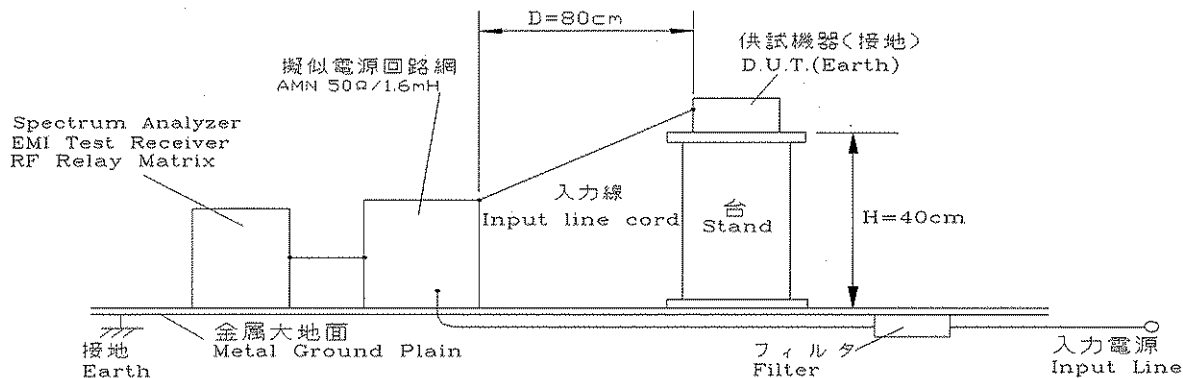

(b) 雑音電界強度 (輻射ノイズ) Radiated Emission Noise

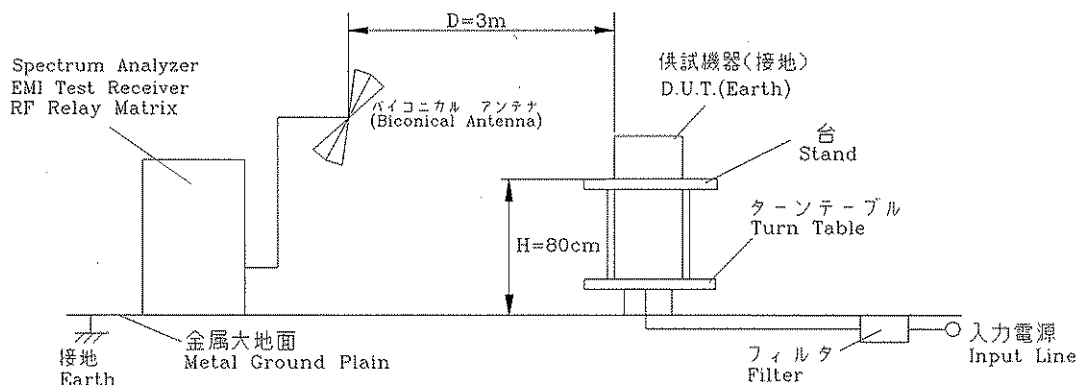

(1) VCCI class A 対応アプリケーションシステム

VCCI class A application system

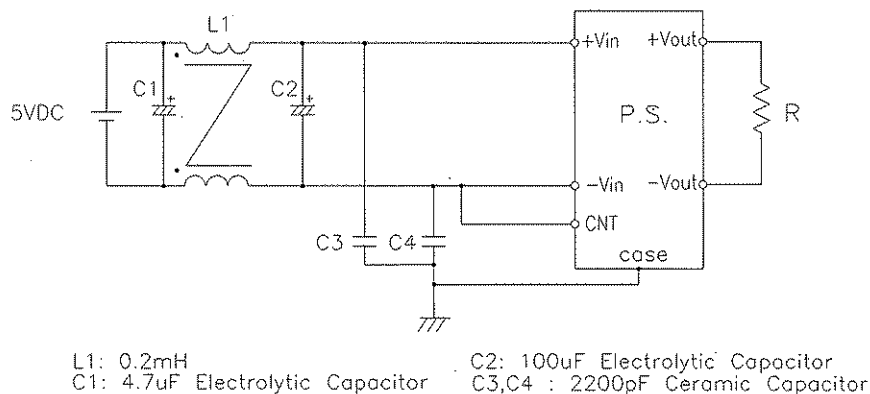

1.2 使用測定機器 List of equipment used

	EQUIPMENT USED	MANUFACTURER	MODEL NO.
1	OSCILLO SCOPE	HITACHI DENSHI	V-1100A
2	DIGITAL STORAGE OSCILLOSCOPE	YOKOGAWA ELECT.	DL1740
3	DIGITAL MULTIMETER	AGILENT	34970A
4	CURRENT PROBE/AMPLIFIER	TEKTRONIX	A6303/TM503B
5	SHUNT RESISTER	YOKOGAWA ELECT.	2215
6	DYNAMIC DUMMY LOAD	TAKASAGO	FK-400L
7	INPUT POWER SUPPLY	DENSEI-LAMBDA	GEN100-7.5
8	CONTROLLED TEMP. CHAMBER	TABAI ESPEC	SU-261
9	SPECTRUM ANALYZER	ROHDE & SCHWARZ	FSA
10	EMI TEST RECEIVER	ROHDE & SCHWARZ	ESHS10
11	EMI TEST RECEIVER	ROHDE & SCHWARZ	ESVS10
12	RF RELAY MATRIX	ROHDE & SCHWARZ	PSU
13	AMN	KYORITU DENSHI	KNW-242
14	ANTENNA(BICONICAL ANTENNA)	SCHWARZBECK	BBA9106

2. 特性データ Characteristics

2.1 静特性 Steady state data

(1) 入力・負荷・温度変動 Regulation - line and load, temperature drift

3.3V

1. Regulation - line and load

Condition Ta : 25°C

Iout \ Vin	4.5VDC	5VDC	9VDC	line regulation	
0%	3.262V	3.263V	3.263V	1.0mV	0.031%
50%	3.261V	3.262V	3.262V	1.0mV	0.031%
100%	3.261V	3.261V	3.261V	0.0mV	0.000%
load	1.0mV	2.0mV	2.0mV		
regulation	0.03%	0.06%	0.06%		

2. Temperature drift

Conditions Vin : 5VDC

Iout : 100%

Ta	-40°C	25°C	85°C	temperature stability	
Vout	3.230V	3.261V	3.268V	38.0mV	1.17%

5V

1. Regulation - line and load

Condition Ta : 25°C

Iout \ Vin	4.5VDC	5VDC	9VDC	line regulation	
0%	4.974V	4.974V	4.975V	1.0mV	0.020%
50%	4.974V	4.974V	4.974V	0.0mV	0.000%
100%	4.973V	4.973V	4.973V	0.0mV	0.000%
load	1.0mV	1.0mV	2.0mV		
regulation	0.02%	0.02%	0.04%		

2. Temperature drift

Conditions Vin : 5VDC

Iout : 100%

Ta	-40°C	25°C	85°C	temperature stability	
Vout	4.955V	4.973V	4.970V	18.0mV	0.36%

2. 特性データ Characteristics

2.1 静特性 Steady state data

(1) 入力・負荷・温度変動 Regulation - line and load, temperature drift

12V

1. Regulation - line and load

Condition Ta : 25°C

Iout \ Vin	4.5VDC	5VDC	9VDC	line regulation	
0%	12.049V	12.050V	12.051V	2.0mV	0.017%
50%	12.049V	12.049V	12.049V	0.0mV	0.000%
100%	12.048V	12.048V	12.048V	0.0mV	0.000%
load	1.0mV	2.0mV	3.0mV		
regulation	0.01%	0.02%	0.02%		

2. Temperature drift

Conditions Vin : 5VDC

Iout : 100%

Ta	-40°C	25°C	85°C	temperature stability	
Vout	11.998V	12.048V	12.050V	52.0mV	0.43%

2.1 (2) 出力電圧・リップル電圧対入力電圧
Output voltage and ripple voltage v.s. input voltage

Conditions Iout : 100 %

Ta : -40 °C -----
25 °C - - - - -
85 °C _____

3.3V

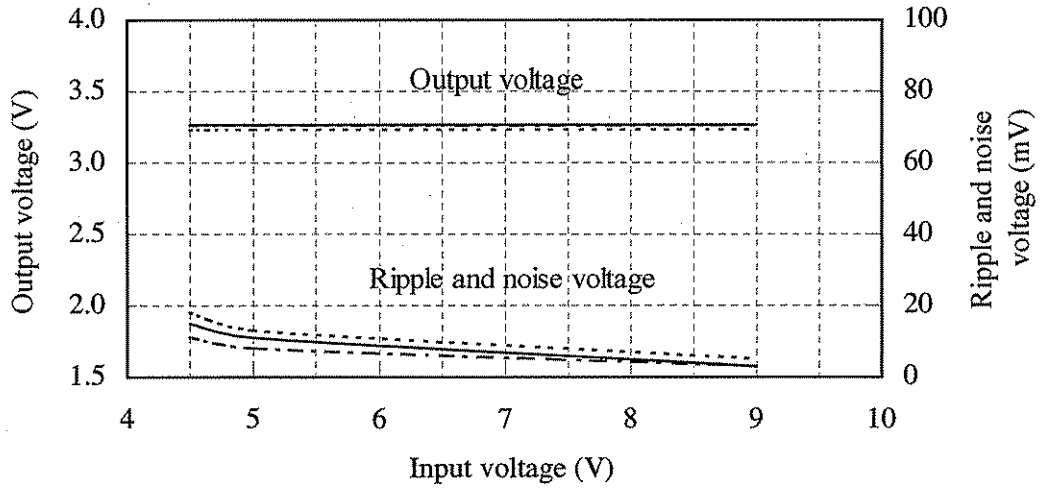

Ta : -40 °C -----
25 °C - - - - -
85 °C _____

5V

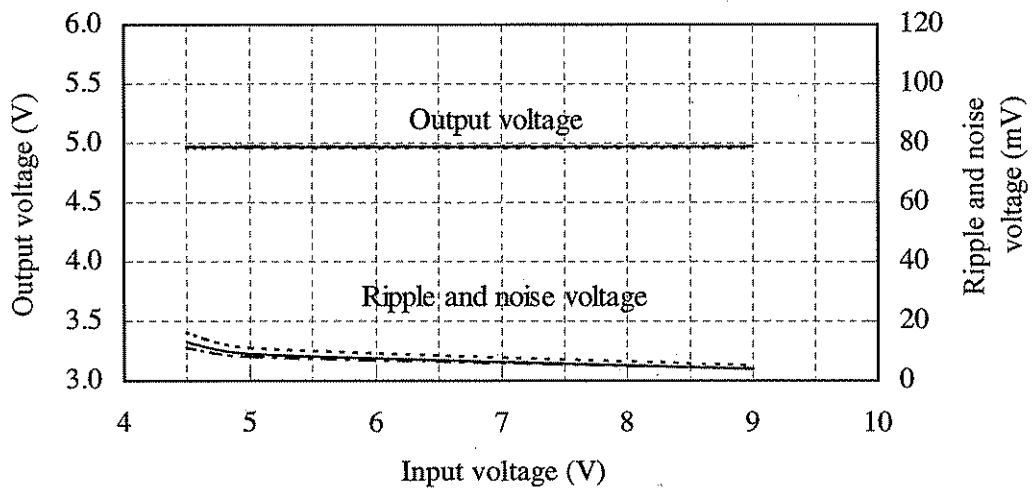

2.1 (2) 出力電圧・リップル電圧対入力電圧

Output voltage and ripple voltage v.s. input voltage

Conditions Iout : 100 %

Ta : -40 °C -----

25 °C - - - - -

85 °C _____

12V

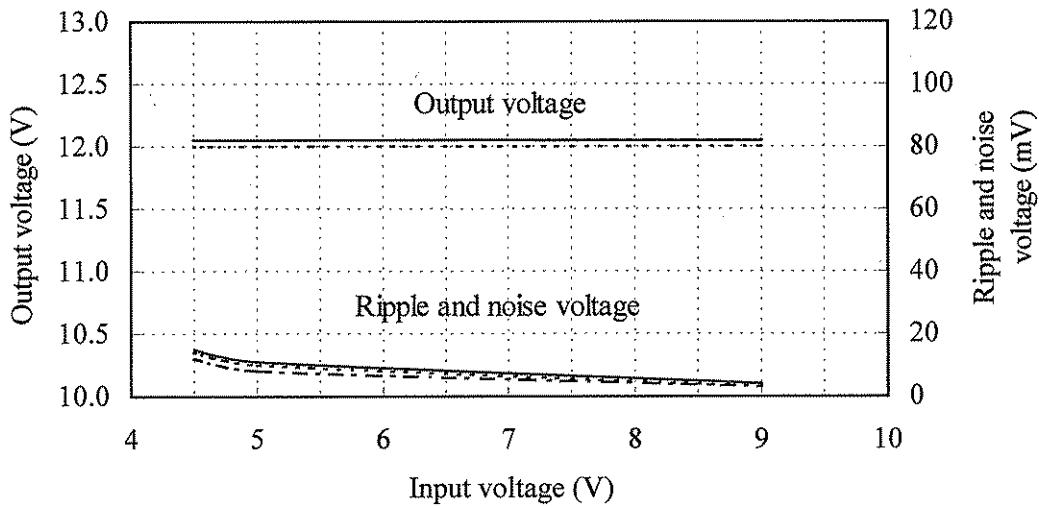

2.1 (3) 効率・入力電流対出力電流

Efficiency and input current v.s. output current

Conditions V_{in} : 4.5 VDC -----
 : 5 VDC - - - - -
 : 9 VDC ————
 T_a : 25 °C

3.3V

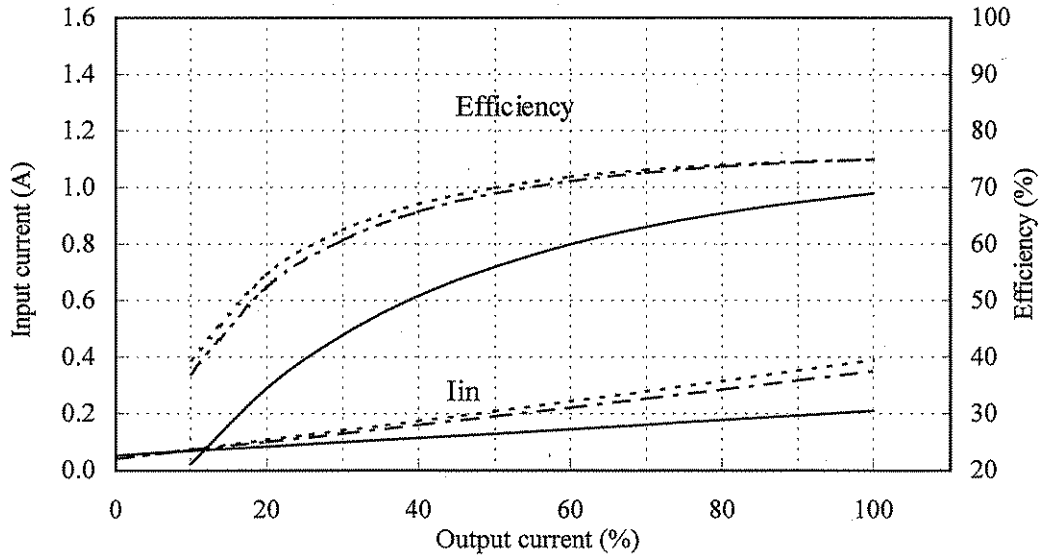

5V

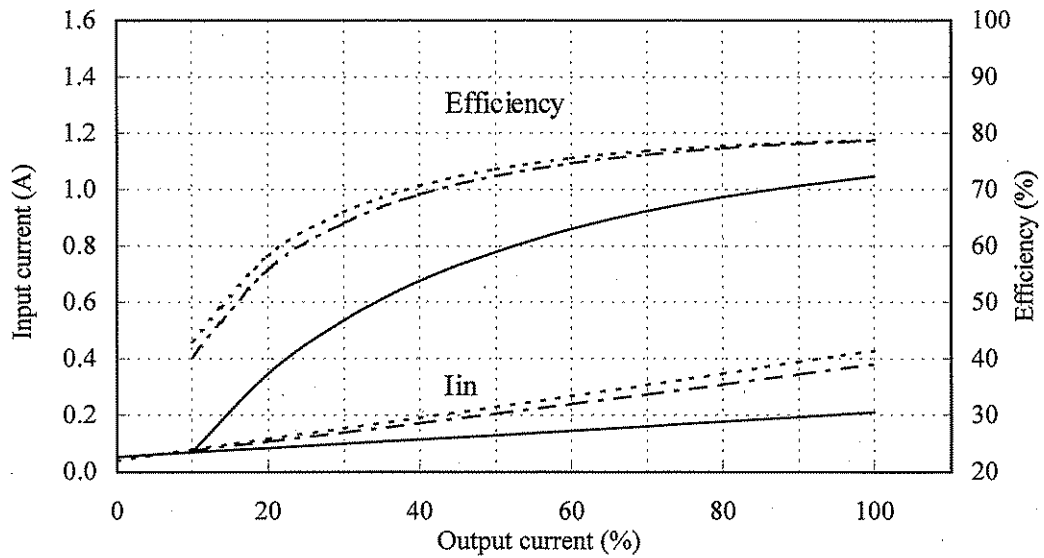

2.1 (3) 効率・入力電流対出力電流

Efficiency and input current v.s. output current

Conditions V_{in} : 4.5 VDC -----
 : 5 VDC - - - - -
 : 9 VDC ————
 T_a : 25 °C

12V

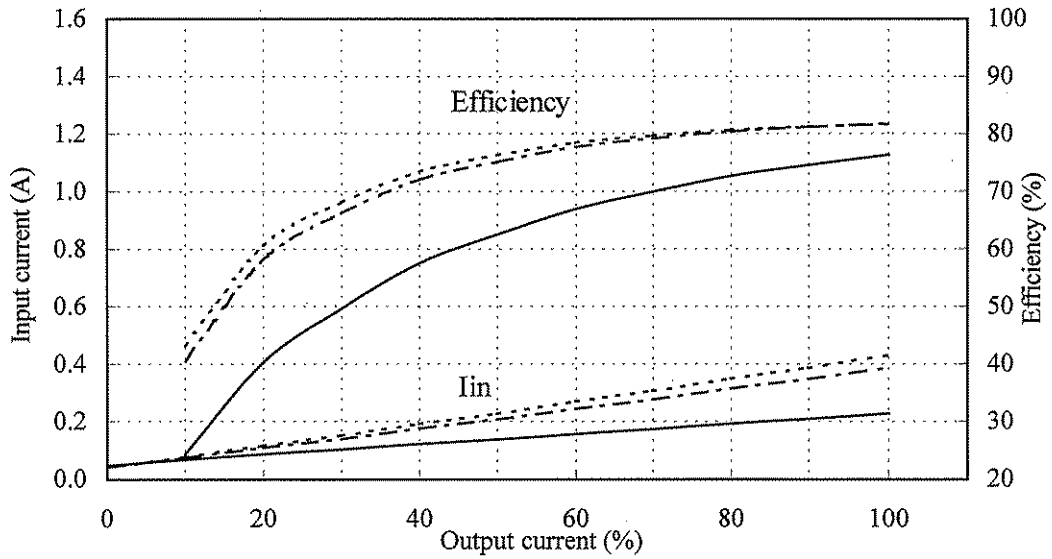

2.1 (4) 効率対入力電圧
Efficiency v.s. input voltage

Conditions Ta : 25 °C

Iout : 50 % -----

100 % _____

3.3V

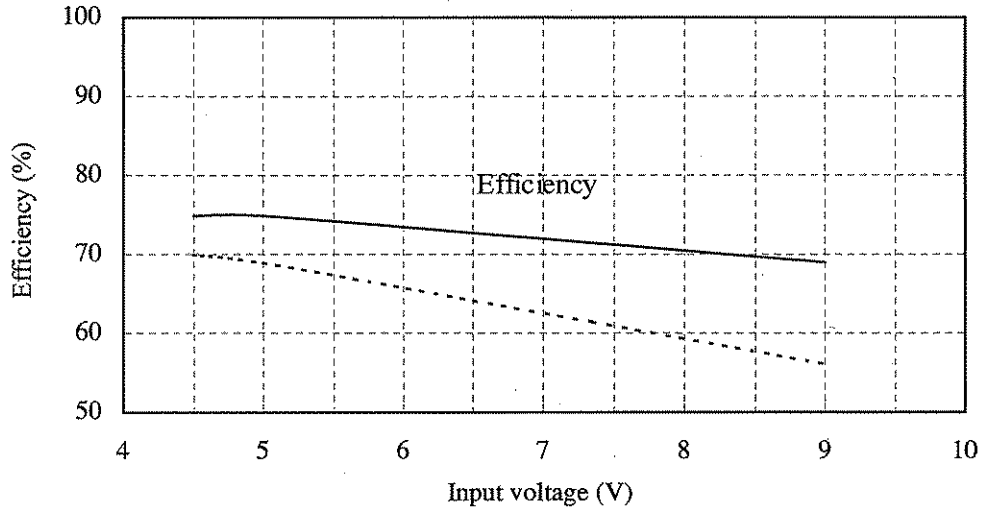

5V

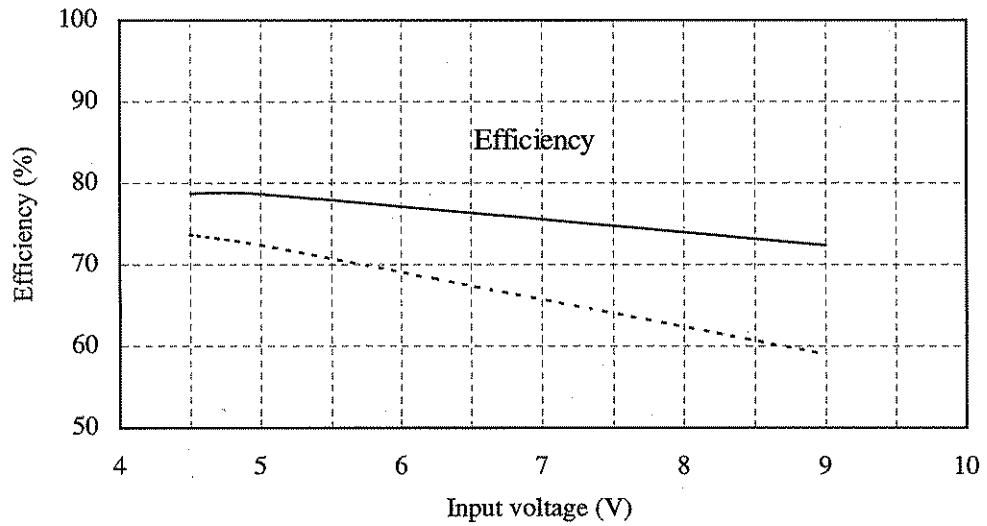

2.1 (4) 効率対入力電圧
Efficiency v.s. input voltage

Conditions Ta : 25 °C

Iout : 50 % -----

100 % _____

12V

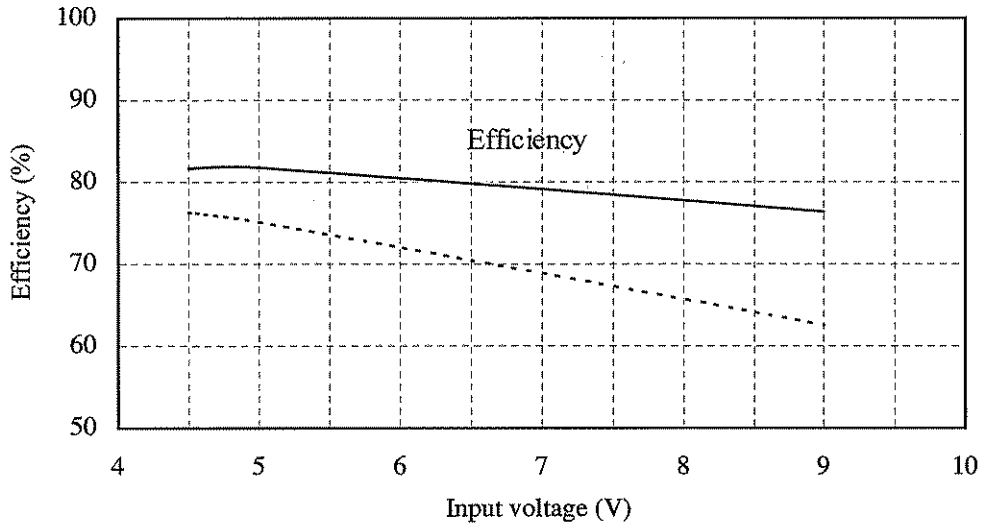

2.2 通電ドリフト特性

Warm up voltage drift characteristics

Conditions V_{in} : 5 VDC

I_{out} : 100 %

T_a : 25 °C

3.3V

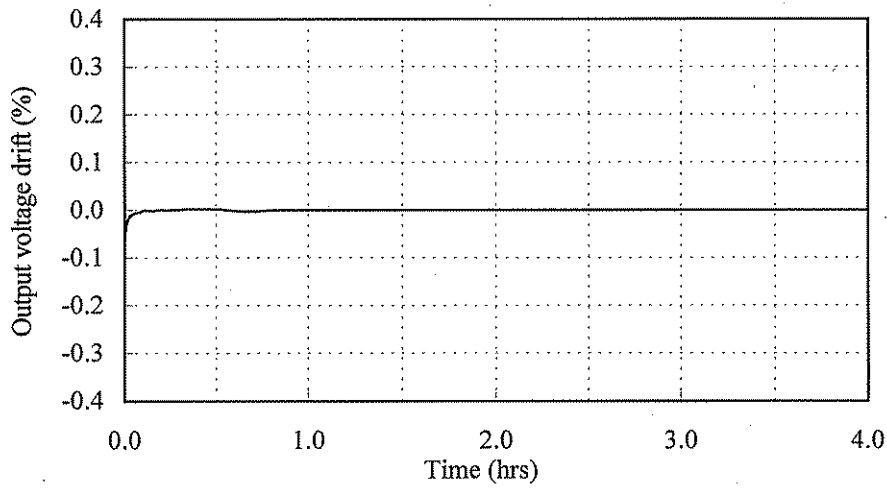

5V

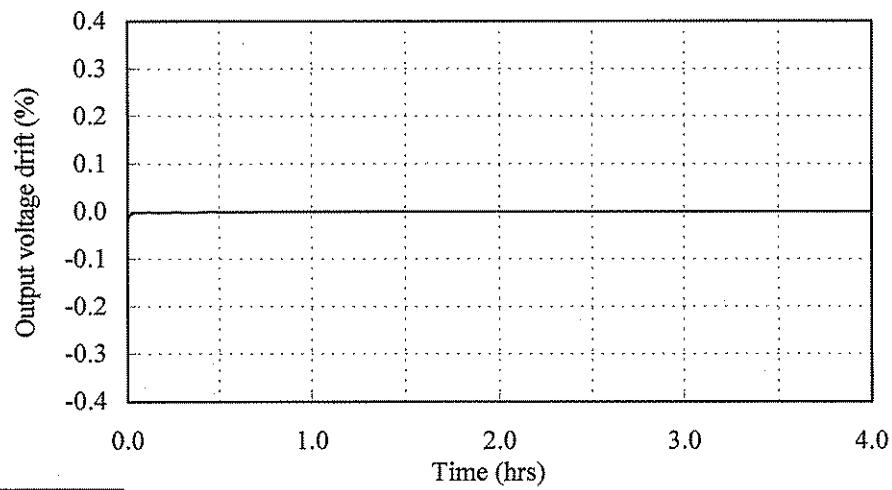

12V

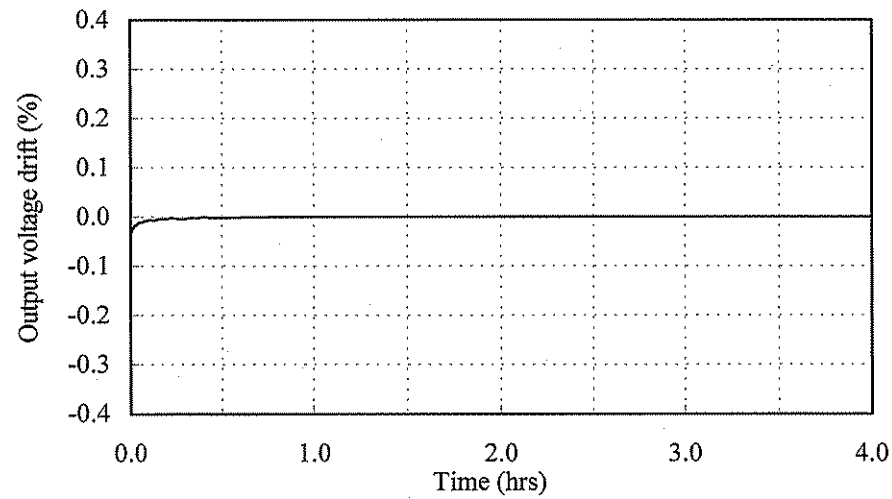

2.3 過電流保護特性

Over current protection (OCP) characteristics

Conditions Vin : 4.5 VDC -----
 5 VDC - - - - -
 9 VDC _____

Ta : 25 °C

3.3V

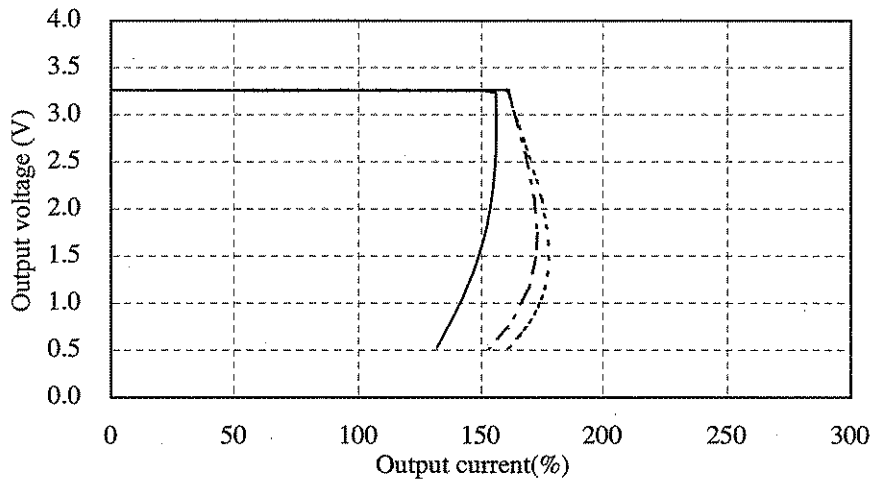

5V

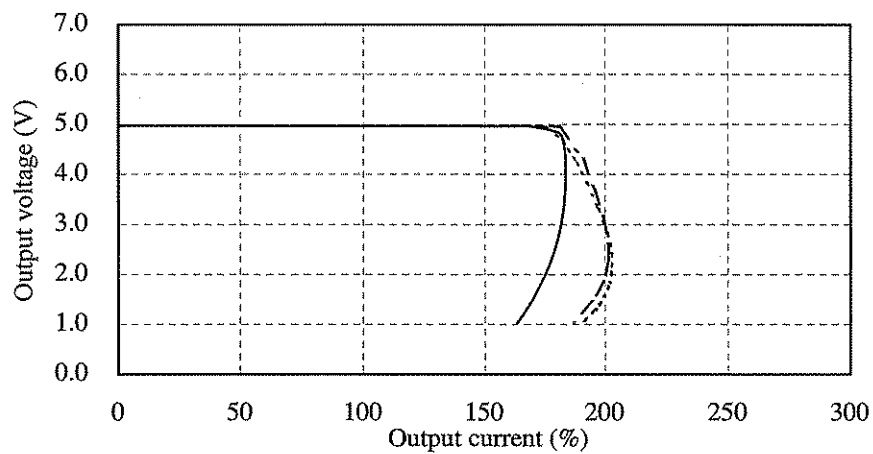

12V

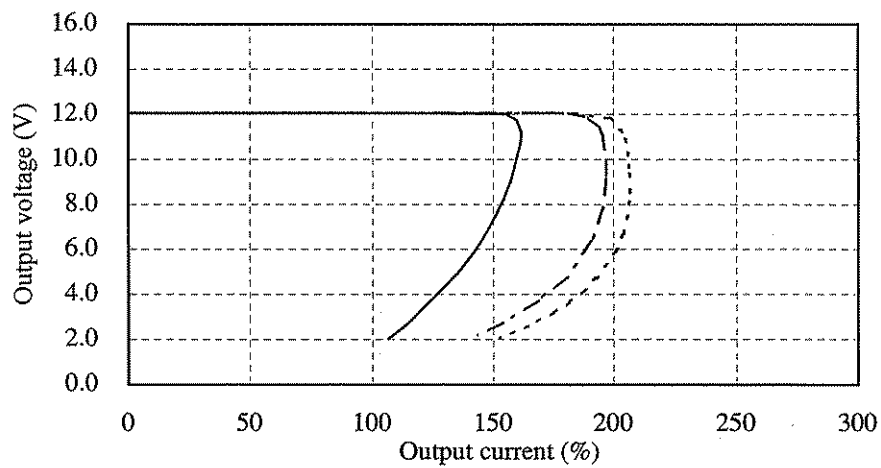

2.3 過電流保護特性
Over current protection (OCP) characteristics

Conditions Vin : 5 VDC
 Ta : -40 °C -----
 25 °C - - - - -
 85 °C ———

3.3V

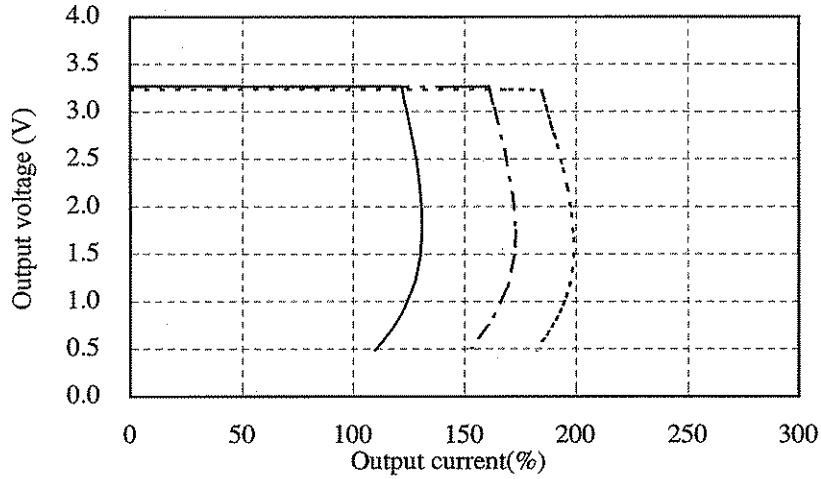

5V

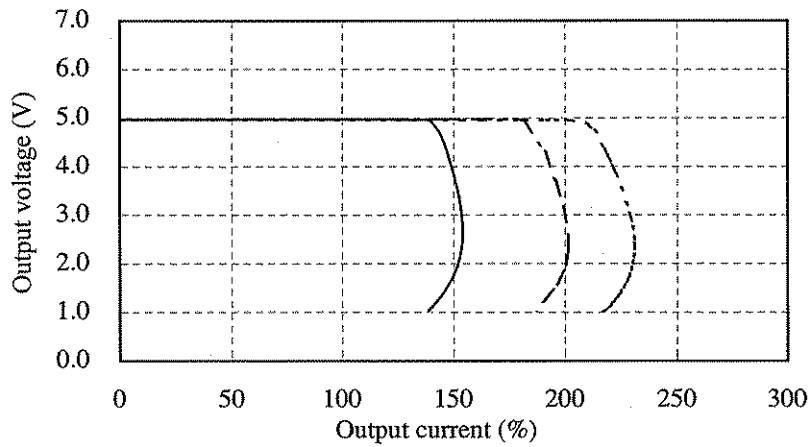

12V

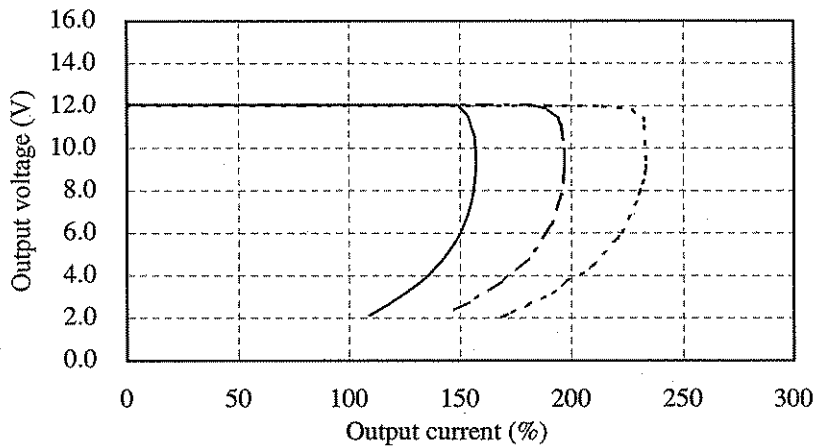

2.4 出力立ち上がり特性
Output rise characteristics

PSS1R5-5-*

Conditions Vin : 5 VDC
Iout : 0 %
Ta : 25 °C

3.3V

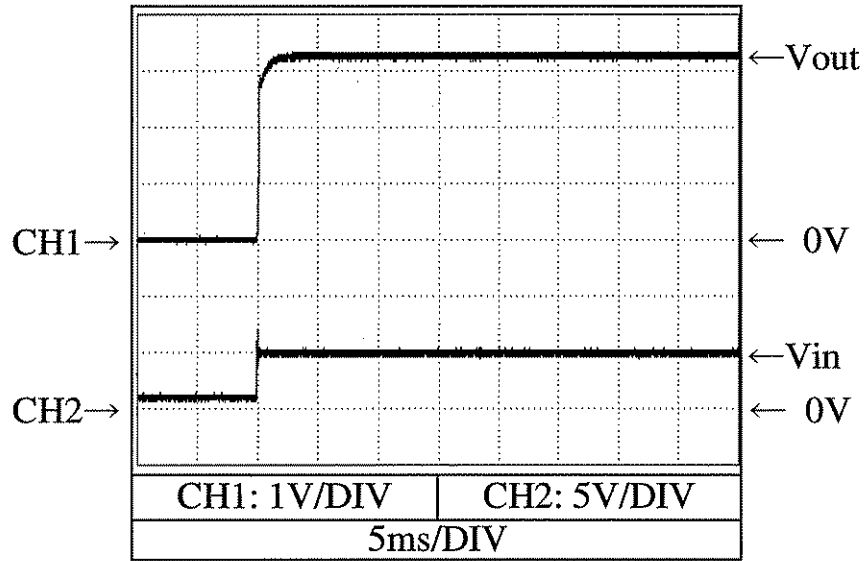

5V

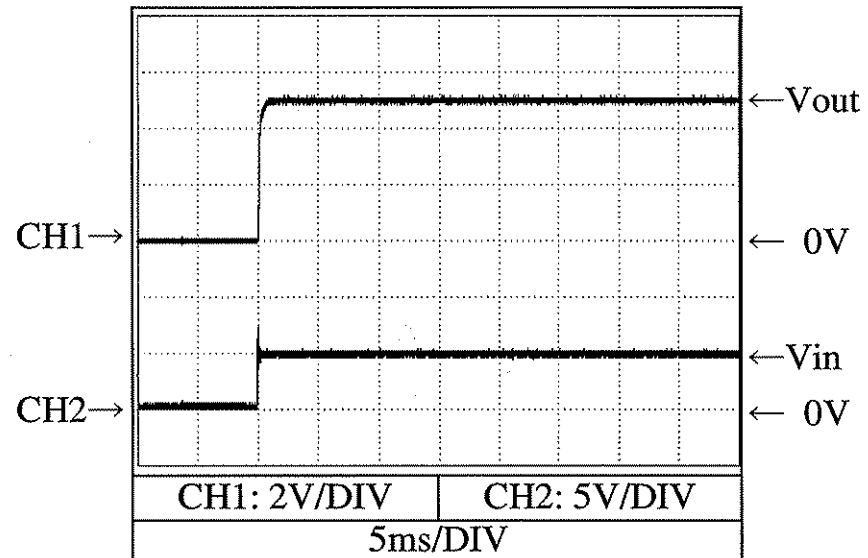

12V

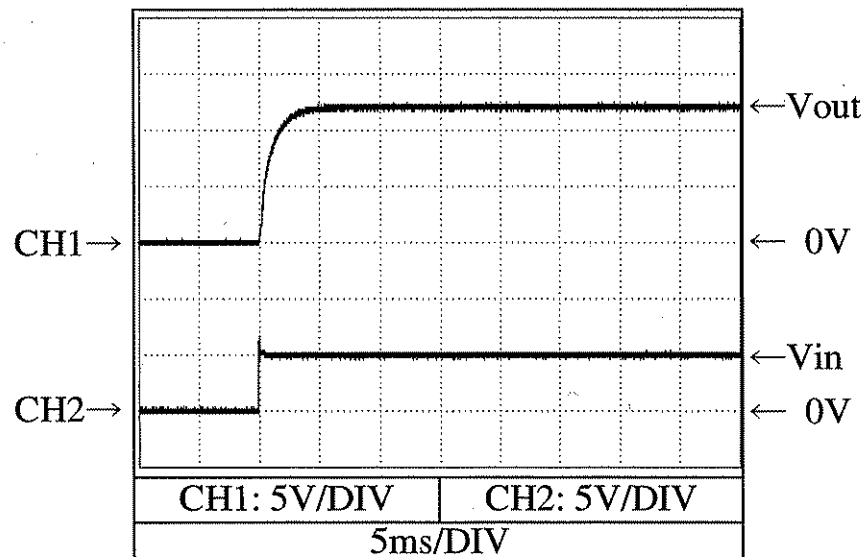

2.4 出力立ち上がり特性
Output rise characteristics

PSS1R5-5-*

Conditions Vin : 5 VDC
Iout : 100 %
Ta : 25 °C

3.3V

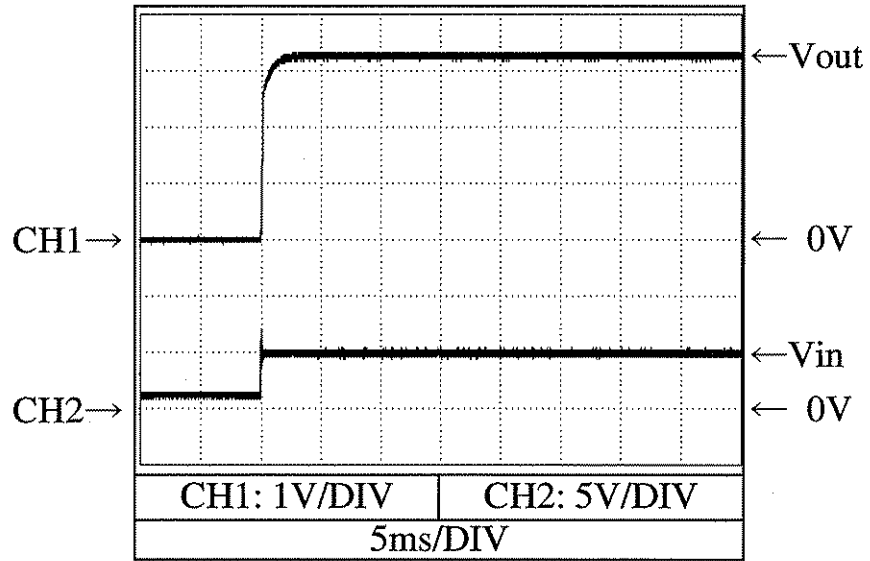

5V

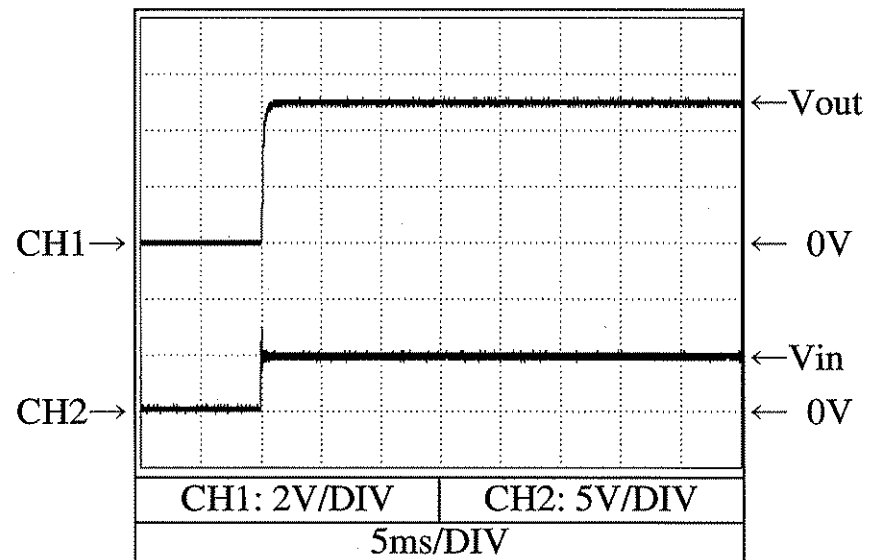

12V

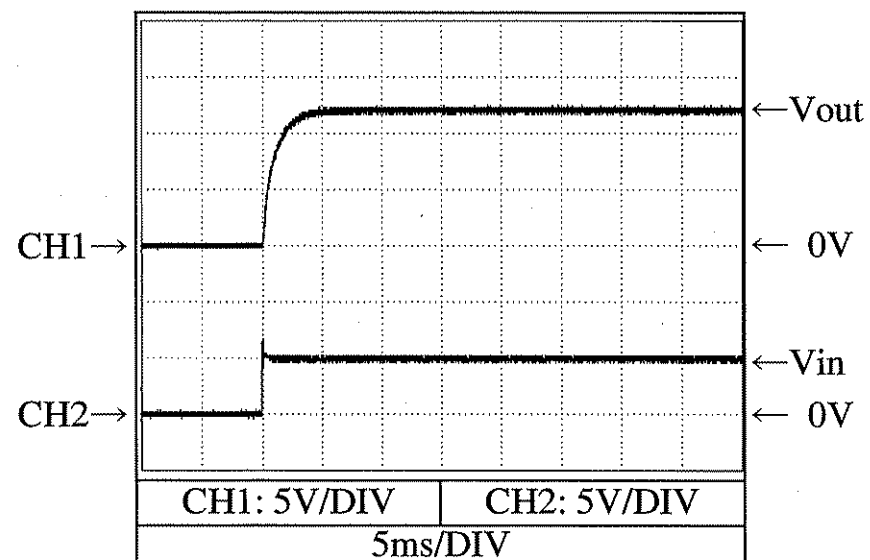

2.5 出力立ち下がり特性
Output fall characteristics

PSS1R5-5-*

Conditions Vin : 5 VDC
Iout : 0 %
Ta : 25 °C

3.3V

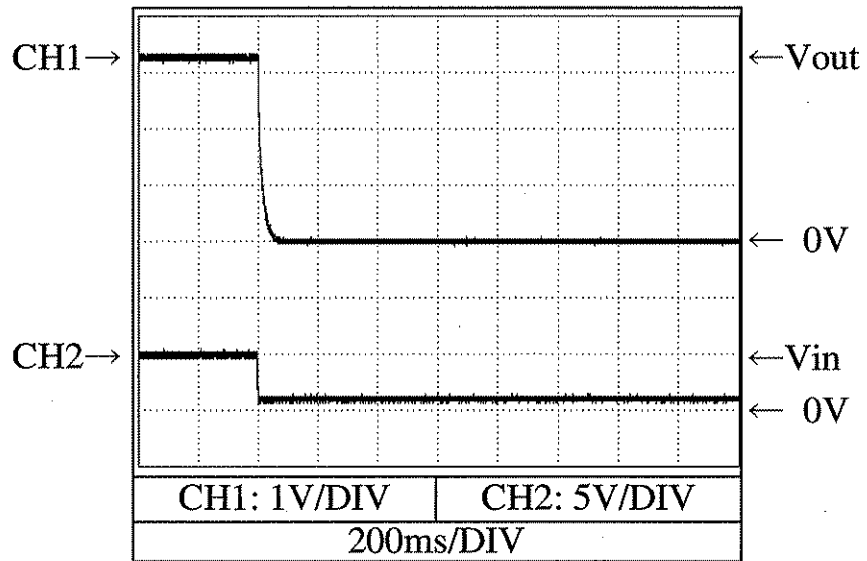

5V

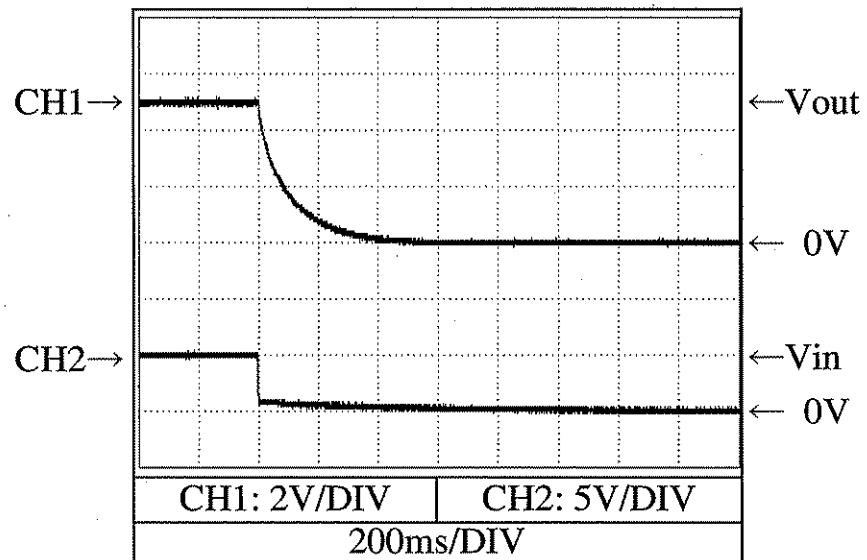

12V

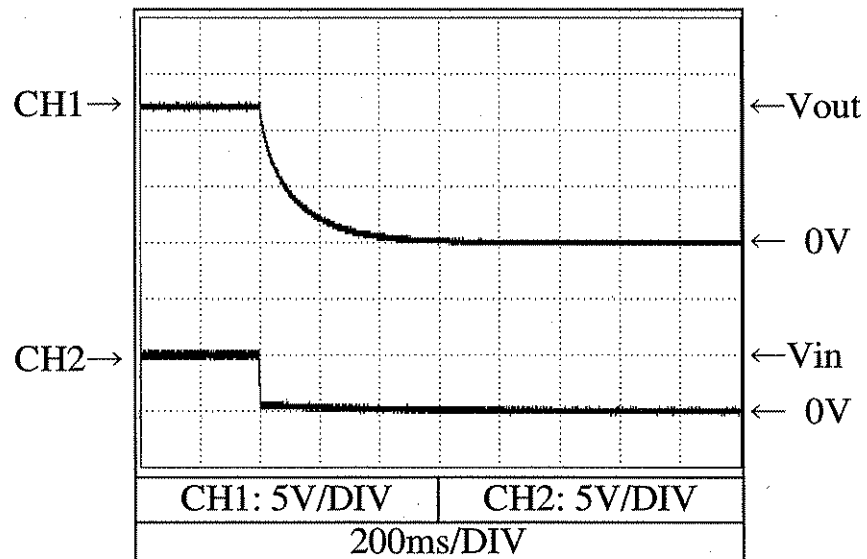

2.5 出力立ち下がり特性
Output fall characteristics

PSS1R5-5-*

Conditions Vin : 5 VDC
Iout : 100 %
Ta : 25 °C

3.3V

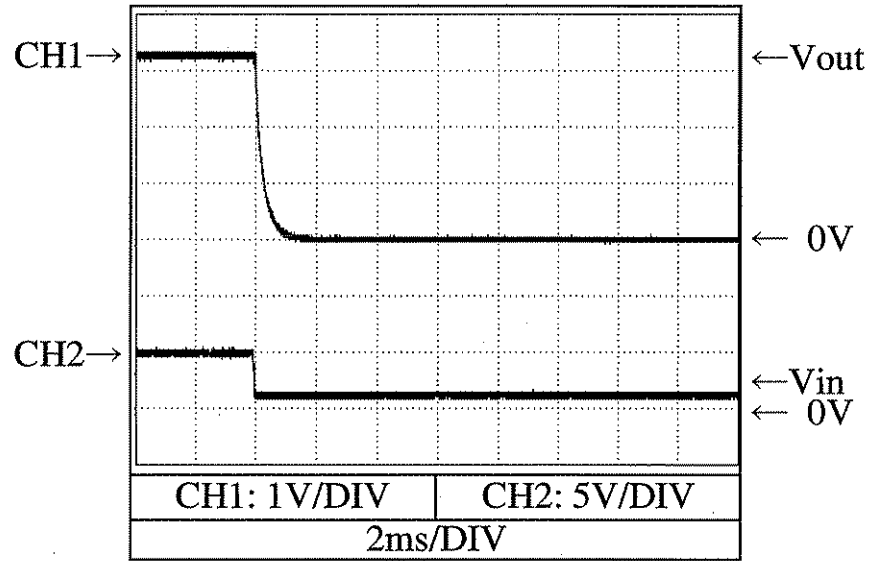

5V

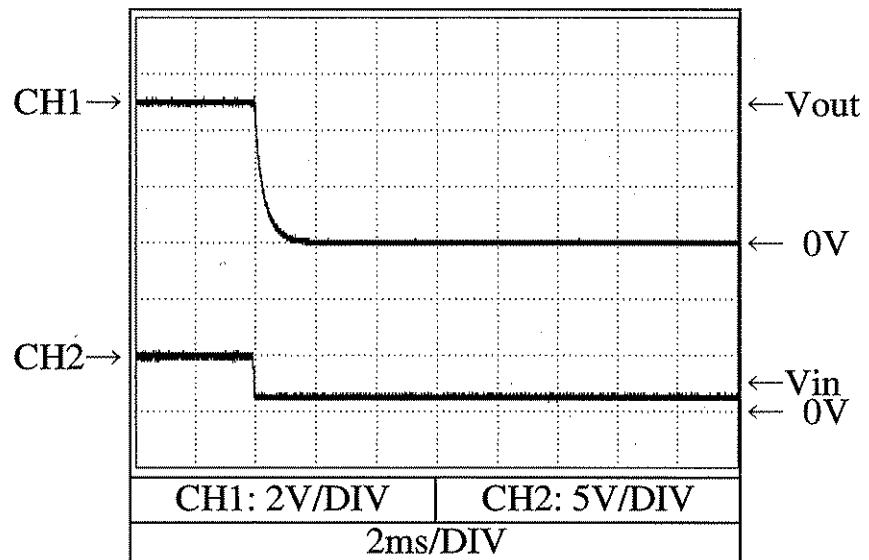

12V

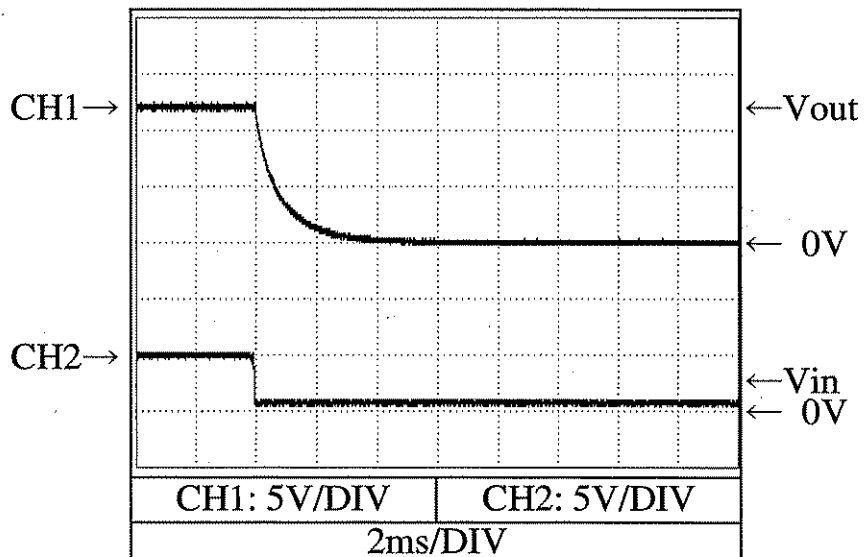

2.6 過渡応答 (負荷急変) 特性
Dynamic load response characteristics

Conditions Vin : 5 VDC
Ta : 25 °C

3.3V

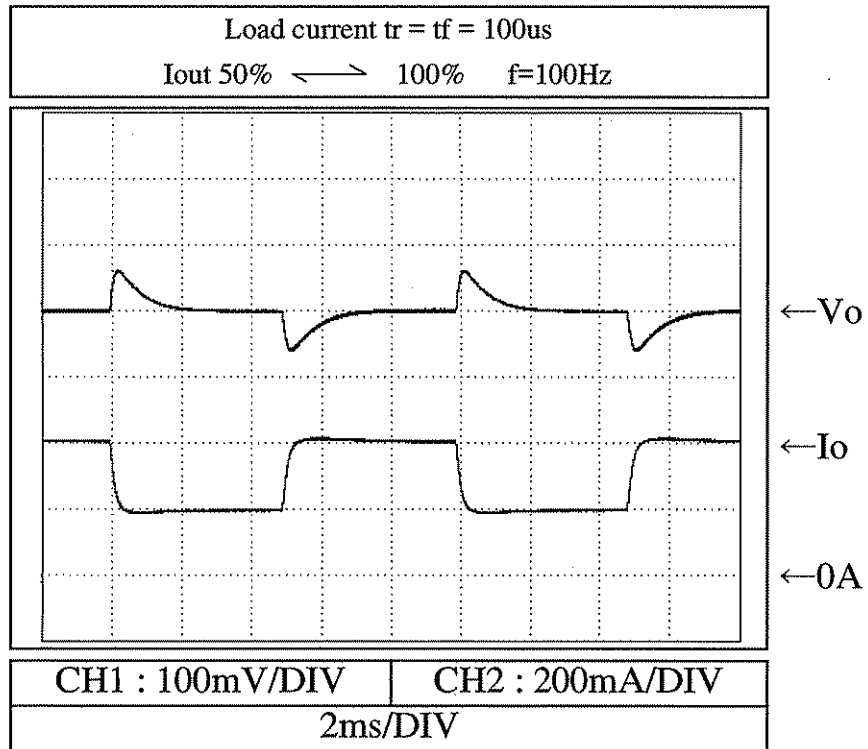

5V

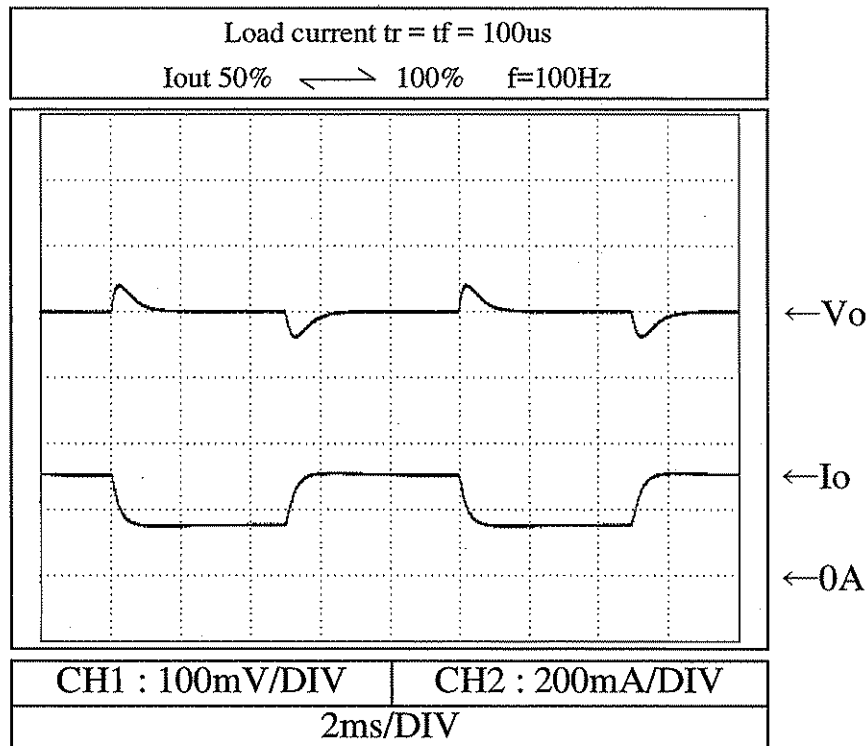

2.6 過渡応答 (負荷急変) 特性
Dynamic load response characteristics

Conditions Vin : 5 VDC
Ta : 25 °C

12V

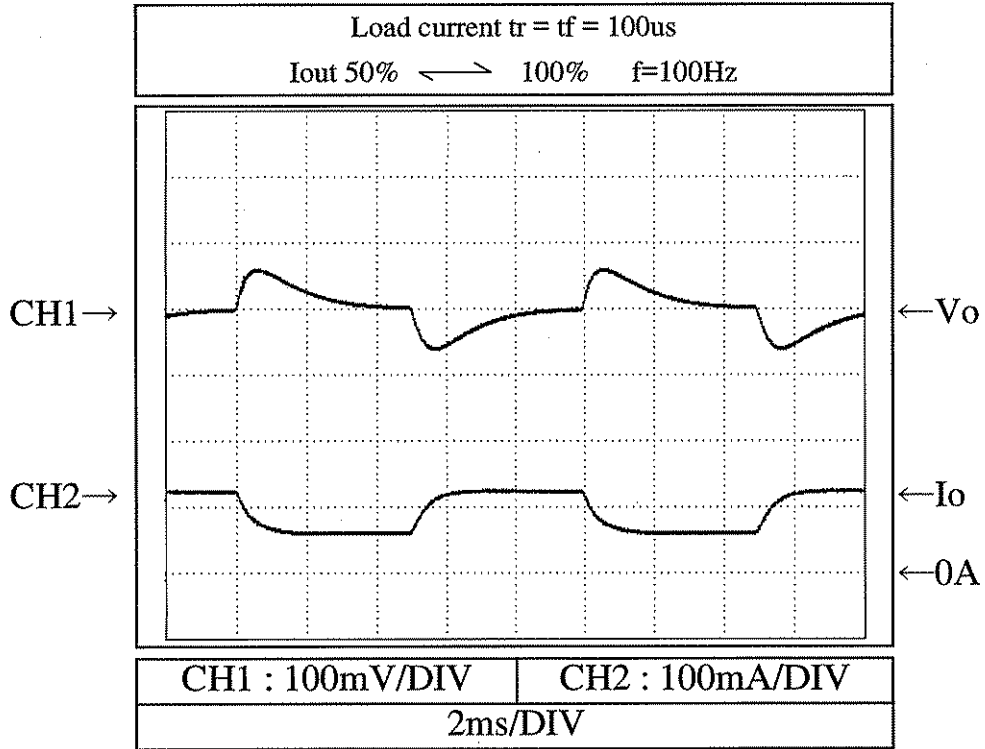

2.7 入力サージ電流 (突入電流) 特性
Inrush current waveform

Conditions Vin : 9 VDC
Iout : 100 %
Ta : 25 °C

5V

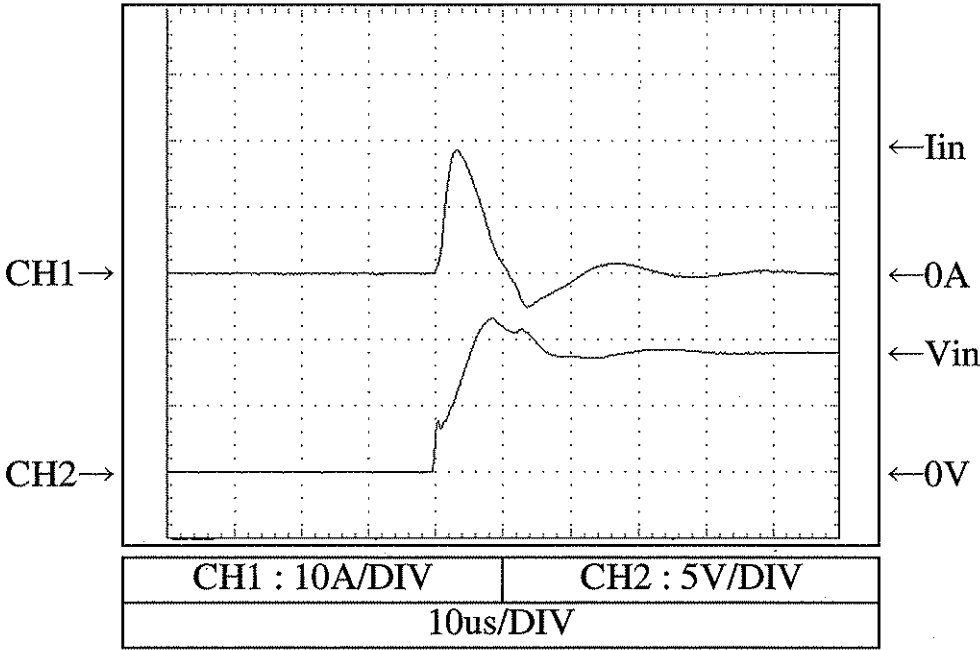

2.8 出力リップル、ノイズ波形
Output ripple and noise waveform

PSS1R5-5-*

Conditions Vin : 5 VDC

Iout : 100 %

Ta : 25 °C

3.3V

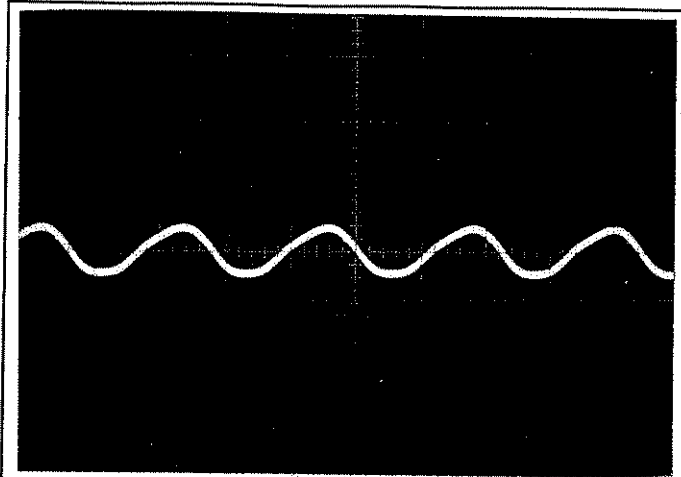

10mV/DIV

2 μ s/DIV

8mVp-p

5V

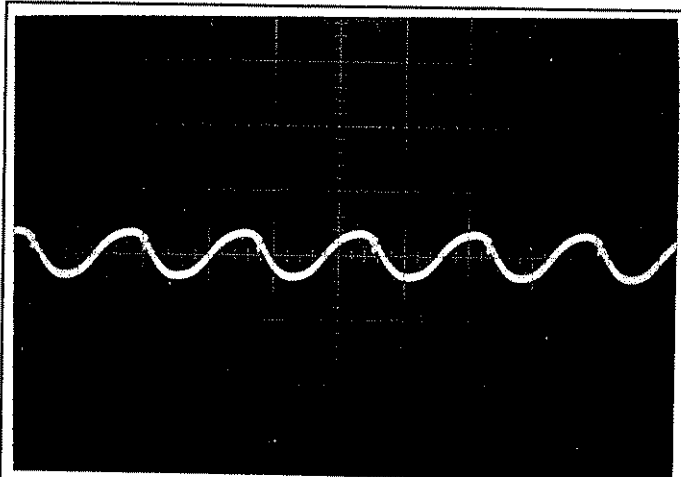

10mV/DIV

2 μ s/DIV

8mVp-p

12V

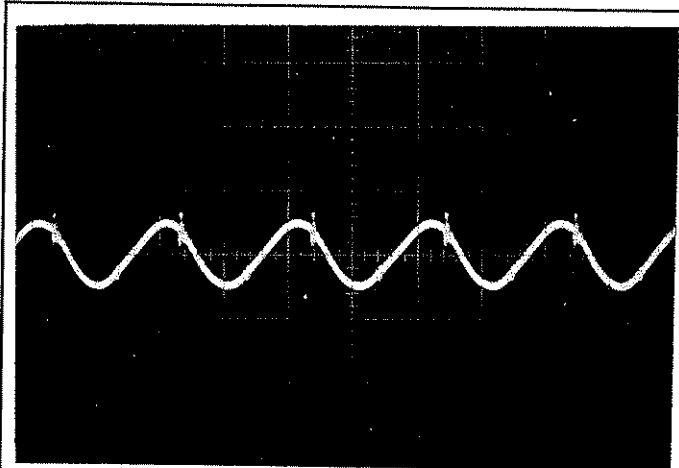

10mV/DIV

2 μ s/DIV

12mVp-p

2.9 スイッチング周波数対出力電力
Switching frequency v.s. output power

Conditions Vin : 4.5 VDC -----
5 VDC - - - - -
9 VDC ————
Ta : 25 °C

3.3V

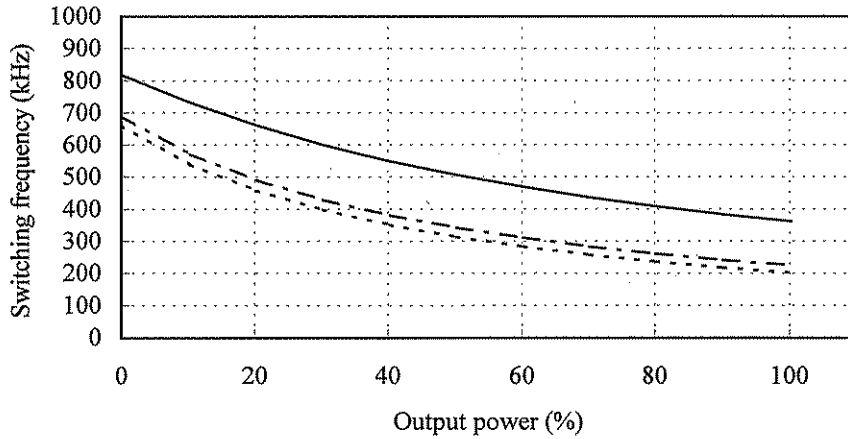

5V

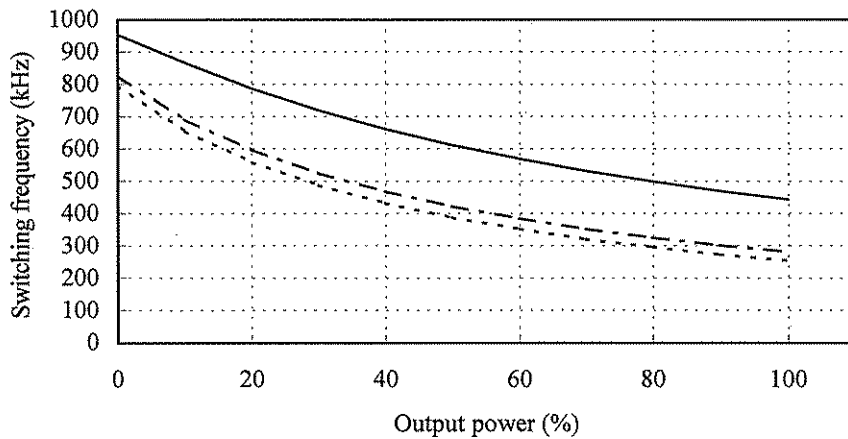

12V

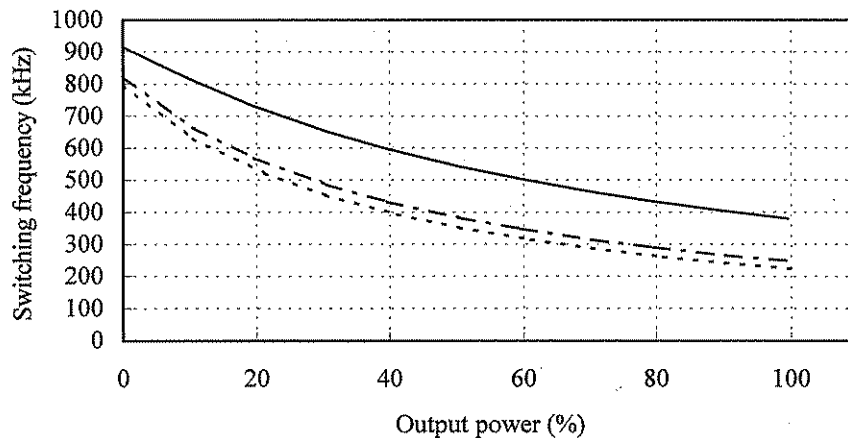

2.10 EMI特性

Electro-Magnetic Interference characteristics

(a) 雑音端子電圧 (帰還ノイズ)

Conducted Emission

VCCI class A 対応アプリケーションシステム

VCCI class A application system

Conditions Vin : 5 VDC

Iout : 100 %

Ta : 25 °C

5V

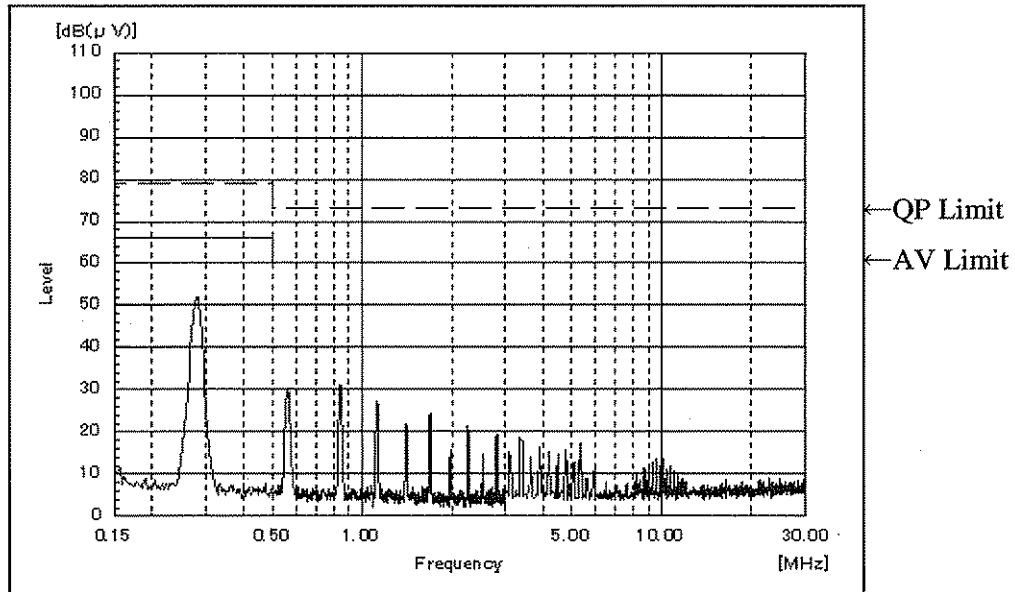

2.10 EMI特性

Electro-Magnetic Interference characteristics

(b) 雑音電界強度 (輻射ノイズ)

Radiated Emission

VCCI class A 対応アプリケーションシステム

VCCI class A application system

Conditions

Vin : 5 VDC

Iout : 100 %

Ta : 25 °C

5V

HORIZONTAL:

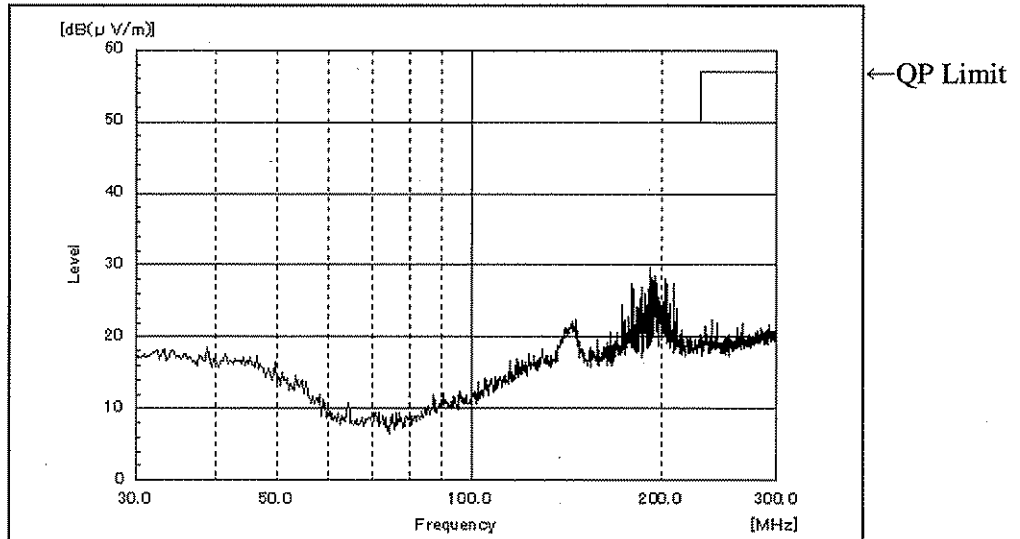

VERTICAL:

