

## DPX15-xxWSxx Single Output: DC-DC Converter Module

9.5 ~ 36VDC, 18 ~ 75VDC input; 3.3 to 15VDC Single Output  
15 Watts Output Power



CE MARKED

SAFETY MEETS: UL60950-1  
EN60950-1  
IEC60950-1

### FEATURES

- NO MINIMUM LOAD REQUIRED
- 1600VDC INPUT TO OUTPUT ISOLATION
- SCREW TERMINALS FOR INPUT AND OUTPUT CONNECTIONS
- RELIABLE SNAP-ON FOR DIN RAIL TS-35/7.5 OR TS-35/15
- CASE PROTECTION MEETS IP20(IEC60529)
- INPUT FUSE PROTECTION
- INPUT REVERSE POLARITY PROTECTION
- INPUT IN-RUSH CURRENT LIMIT CIRCUIT
- OUTPUT DC-OK INDICATOR
- 4:1 WIDE INPUT VOLTAGE RANGE
- FIXED SWITCHING FREQUENCY
- INPUT UNDER-VOLTAGE PROTECTION
- OUTPUT OVER-VOLTAGE PROTECTION
- OVER-CURRENT PROTECTION
- OUTPUT SHORT CIRCUIT PROTECTION
- MEETS EN55022 CLASS B
- REMOTE ON/OFF
- COMPLIANT TO RoHS II & REACH

### APPLICATIONS

- COMMUNICATION SYSTEMS
- INDUSTRY CONTROL SYSTEMS
- FACTORY AUTOMATION EQUIPMENT
- SEMICONDUCTOR EQUIPMENT

### OPTIONS

- REMOTE ON/OFF

### GENERAL DESCRIPTION

The DPX15xxWSxx series was designed for applications requiring din rail mountable DC-DC converters. Easy installation is provided with snap-on mounting to the DIN-rail. Internal circuits provide protection against reverse input voltage, input in-rush current, output short-circuit, output over-current, and output over-voltage conditions. A green LED at the front panel indicates the status of the output voltage.

## Contents

---

|                                 |    |
|---------------------------------|----|
| Output Specifications           | 3  |
| Input Specifications            | 4  |
| General Specifications          | 5  |
| Environmental Specifications    | 5  |
| EMC Characteristics             | 5  |
| Characteristic Curves           |    |
| DPX15-24WS3P3                   | 6  |
| DPX15-24WS05                    | 8  |
| DPX15-24WS5P1                   | 10 |
| DPX15-24WS12                    | 12 |
| DPX15-24WS15                    | 14 |
| DPX15-48WS3P3                   | 16 |
| DPX15-48WS05                    | 18 |
| DPX15-48WS5P1                   | 20 |
| DPX15-48WS12                    | 22 |
| DPX15-48WS15                    | 24 |
| Input Source Impedance          | 26 |
| Output Over Current Protection  | 26 |
| Output Short Circuit Protection | 26 |
| Output Over Voltage Protection  | 26 |
| Remote On/off Control           | 27 |
| EMS Considerations              | 28 |
| Mechanical Data                 | 28 |
| Packaging Information           | 28 |
| Part Number Structure           | 29 |
| MTBF and Reliability            | 29 |

### Output Specifications

| Parameter   | Model  | Min                                      | Typ                            | Max                                      | Unit      |
|---|--|--|--------------------------------|--|-----------|
| <b>Output Voltage</b><br>(Vin(nom); Full Load; Ta=25°C)   | xxWS3P3<br>xxWS05<br>xxWS5P1<br>xxWS12<br>xxWS15 | 3.234<br>4.94<br>5.04<br>11.856<br>14.82 | 3.3<br>5<br>5.1<br>12<br>15    | 3.366<br>5.06<br>5.16<br>12.144<br>15.18 | VDC       |
| <b>Output Regulation</b><br>Line (Vin(min) to Vin(max); Full Load)<br>Load (0% to 100% of Full Load)  | All<br>xxWS3P3<br>Other                          | -0.2<br>-2.0<br>-1.5                     |                                | +0.2<br>+2.0<br>+1.5                     | %         |
| <b>Output Ripple and Noise</b><br>Peak to Peak (20MHz Bandwidth)  | xxWS3P3<br>xxWS05<br>xxWS5P1<br>xxWS12<br>xxWS15 |  | 50<br>50<br>50<br>75<br>75     | 75<br>75<br>75<br>100<br>100             | mVp-p     |
| <b>Temperature Coefficient</b>  | All  | -0.02                                    |                                | +0.02                                    | %/°C      |
| <b>Output Voltage Overshoot</b><br>(Vin(min) to Vin(max) Full Load; Ta=25°C)  | All  |  | 0                              | 5  | % of Vout |
| <b>Dynamic Load Response</b><br>(Vin(nom); Ta=25°C)<br>Load step change from<br>75% to 100% or 100 to 75% of Full Load<br>Peak Deviation<br>Settling Time (Vo < 10% peak deviation) | All<br>All                                       |  | 250<br>250                     |  | mV<br>µs  |
| <b>Output Current</b>   | xxWS3P3<br>xxWS05<br>xxWS5P1<br>xxWS12<br>xxWS15 | 0<br>0<br>0<br>0<br>0                    |                                | 4.5<br>3<br>3<br>1.25<br>1               | A         |
| <b>Output Capacitance Load</b>  | xxWS3P3<br>xxWS05<br>xxWS5P1<br>xxWS12<br>xxWS15 |  |                                | 14700<br>7200<br>7200<br>1250<br>800     | µF        |
| <b>Output Over Voltage Protection</b> (see page 26)<br>(Zener diode clamp)  | xxWS3P3<br>xxWS05<br>xxWS5P1<br>xxWS12<br>xxWS15 |  | 3.9<br>6.2<br>6.2<br>15<br>18  |  | VDC       |
| <b>Output Indicator</b>   | All  |  | Green LED                      |  |           |
| <b>Output Over Current Protection</b> (see page 26)<br>(% of Iout rated; Hiccup mode)   | All  |  | 150                            |  | % of FL   |
| <b>Output Short Circuit Protection</b> (see page 26)  | All  |  | Continuous, automatic recovery |  |           |

### Input Specifications

| Parameter  | Model            | Min  | Typ                                      | Max | Unit  |
|--|------------------|------|--|-----|-------|
| <b>Operating Input Voltage</b><br>Continuous   | 24WSxx           | 9.5  | 24                                       | 36  | VDC   |
|  | 48WSxx           | 18   | 48                                       | 75  |       |
| Transient (100ms,max)  | 24WSxx           |      |  | 50  |       |
|  | 48WSxx           |      |  | 100 |       |
| <b>Input Standby Current</b><br>(Vin(nom); No Load)  | 24WS3P3          |      | 52                                       |     | mA    |
|  | 24WS05           |      | 67                                       |     |       |
|  | 24WS5P1          |      | 67                                       |     |       |
|  | 24WS12           |      | 26                                       |     |       |
|  | 24WS15           |      | 26                                       |     |       |
|  | 48WS3P3          |      | 37                                       |     |       |
|  | 48WS05           |      | 38                                       |     |       |
|  | 48WS5P1          |      | 38                                       |     |       |
|  | 48WS12           |      | 18                                       |     |       |
|  | 48WS15           |      | 18                                       |     |       |
| <b>Under Voltage Lockout Turn-on Threshold</b>   | 24WSxx           |      |  | 9.5 | VDC   |
|  | 48WSxx           |      |  | 18  |       |
| <b>Under Voltage Lockout Turn-off Threshold</b>  | 24WSxx           |      | 7.5                                      |     | VDC   |
|  | 48WSxx           |      | 15                                       |     |       |
| <b>Input Reflected Ripple Current</b> (see page 26)<br>(Vin(nom); Full Load)   | All              |      | 10                                       |     | mAp-p |
| <b>Start Up Time</b><br>(Vin(nom) and constant resistive load)   | All              |      | 100                                      |     | ms    |
| <b>Remote ON/OFF Control</b> (see page 27)<br>(The Ctrl pin voltage is referenced to negative input)<br><b>Positive Logic</b> (Optional)<br>On/Off pin High Voltage (Remote ON)<br>On/Off pin Low Voltage (Remote OFF)<br><b>Negative Logic</b> (Optional)<br>On/Off pin Low Voltage (Remote ON)<br>On/Off pin High Voltage (Remote OFF) | xxWSxx- <b>P</b> |      | Open or 3 ~ 12VDC<br>Short or 0 ~ 1.2VDC |     |       |
|  | xxWSxx- <b>N</b> |      | Short or 0 ~ 1.2VDC<br>Open or 3 ~ 12VDC |     |       |
| <b>Input Current of Remote Control Pin</b>   |                  | -0.5 |  | 0.5 | mA    |
| <b>Remote Off State Input Current</b>  |                  |      | 2.5                                      |     | mA    |
| <b>Input Fuse</b> (Slow Blow)  | 24WSxx           |      | 6  |     | A     |
|  | 48WSxx           |      | 4  |     |       |
| <b>In-rush Current</b>   | All              |      | 15                                       |     | A     |

### General Specifications

| Parameter   | Model   | Min                              | Typ | Max  | Unit  |
|---|---------|----------------------------------|-----|------|-------|
| <b>Efficiency</b><br>(Vin(nom); Full Load; Ta=25°C)   | 24WS3P3 |                                  | 84  |      | %     |
|   | 24WS05  |                                  | 85  |      |       |
|   | 24WS5P1 |                                  | 85  |      |       |
|   | 24WS12  |                                  | 85  |      |       |
|   | 24WS15  |                                  | 85  |      |       |
|   | 48WS3P3 |                                  | 84  |      |       |
|   | 48WS05  |                                  | 86  |      |       |
|   | 48WS5P1 |                                  | 86  |      |       |
|   | 48WS12  |                                  | 85  |      |       |
|   | 48WS15  |                                  | 85  |      |       |
| <b>Isolation Voltage</b> (1 minute)<br>Input to Output<br>Input to Chassis, Output to Chassis | All     | 1600<br>1600                     |     |      | VDC   |
| <b>Isolation Resistance</b> (500VDC)  | All     | 1                                |     |      | GΩ    |
| <b>Isolation Capacitance</b>  | All     |                                  |     | 4000 | pF    |
| <b>Switching Frequency</b>  | All     | 360                              | 400 | 440  | kHz   |
| <b>Safety Meets</b>   | All     | IEC60950-1, UL60950-1, EN60950-1 |     |      |       |
| <b>Weight</b>   | All     | 147.5                            |     |      | g     |
| <b>MTBF</b> (see page 29)<br>MIL-HDBK-217F Ta=25°C, Full load                                 | All     | 1.681 x 10 <sup>6</sup>          |     |      | hours |
| <b>Chassis Material</b>   | All     | Aluminum                         |     |      |       |

### Environmental Specifications

| Parameter                            | Model            | Min          | Typ | Max | Unit |
|--------------------------------------|------------------|--------------|-----|-----|------|
| <b>Operating Ambient Temperature</b> | Without derating | -40          |     | +85 | °C   |
|                                      | With derating    | +85          |     | +93 |      |
| <b>Storage Temperature</b>           | All              | -40          |     | 105 | °C   |
| <b>Relative Humidity</b>             | All              | 5            |     | 95  | % RH |
| <b>Thermal Shock</b>                 | All              | MIL-STD-810F |     |     |      |
| <b>Vibration</b>                     | All              | IEC60068-2-6 |     |     |      |

### EMC Characteristics

| Characteristic                        | Standard    | Condition                           | Level            |
|---------------------------------------|-------------|-------------------------------------|------------------|
| <b>EMI</b>                            | EN55022     | Module stand-alone                  | Class B          |
| <b>ESD</b>                            | EN61000-4-2 | Air                                 | ±8kV             |
|                                       |             | Contact                             | ±6kV             |
| <b>Radiated Immunity</b>              | EN61000-4-3 | 10V/m                               | Perf. Criteria A |
| <b>Fast Transient</b> (see page 28)   | EN61000-4-4 | ±2kV                                | Perf. Criteria A |
| <b>Surge</b> (see page 28)            | EN61000-4-5 | ±0.5kV                              | Perf. Criteria A |
| <b>Conducted Immunity</b>             | EN61000-4-6 | 10V r.m.s                           | Perf. Criteria A |
| <b>Power Frequency Magnetic Field</b> | EN61000-4-8 | 100A/m continuous; 1000A/m 1 second | Perf. Criteria A |

### Characteristic Curves

All test conditions are at 25°C. The figures are for DPX15-24WS3P3

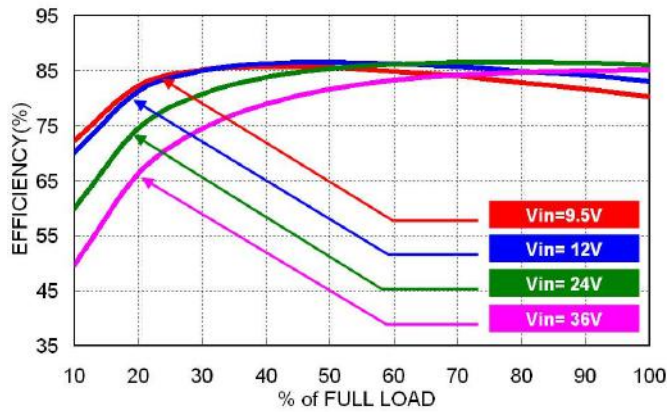

Efficiency versus Output Load

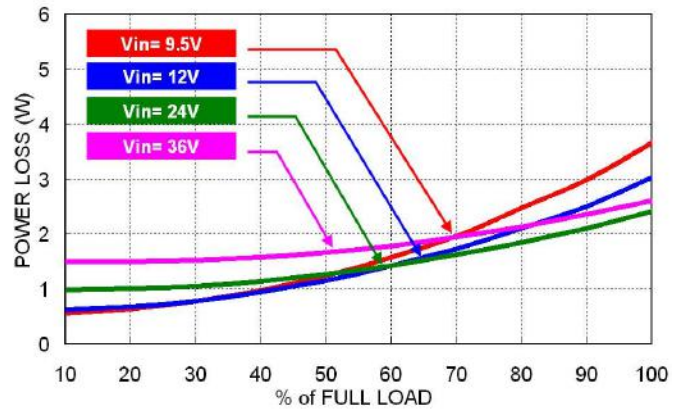

Power Dissipation versus Output Load

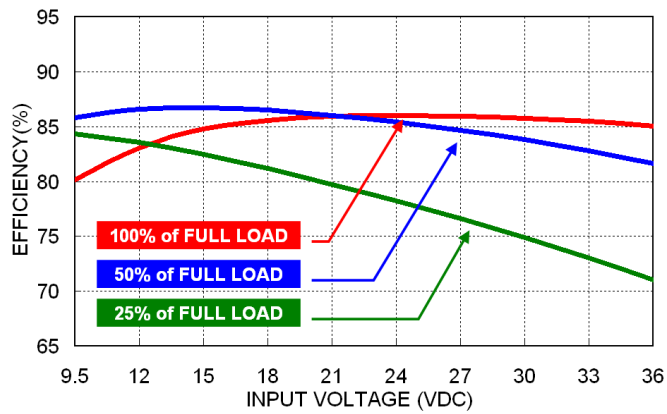

Efficiency versus Input Voltage

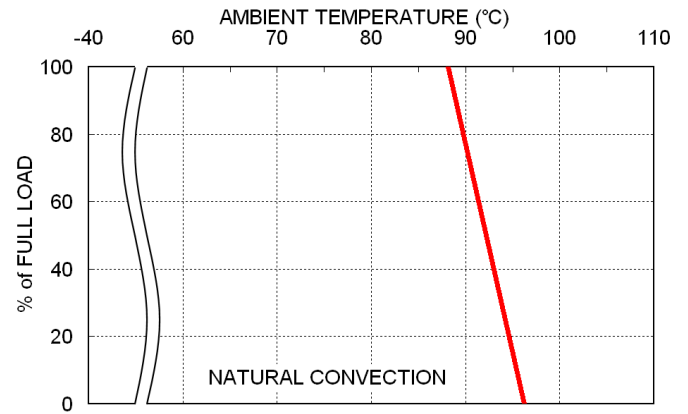

Derating Output Current versus Ambient Temperature and Airflow  
Vin(nom)

### Characteristic Curves (Continued)

All test conditions are at 25°C. The figures are for DPX15-24WS3P3

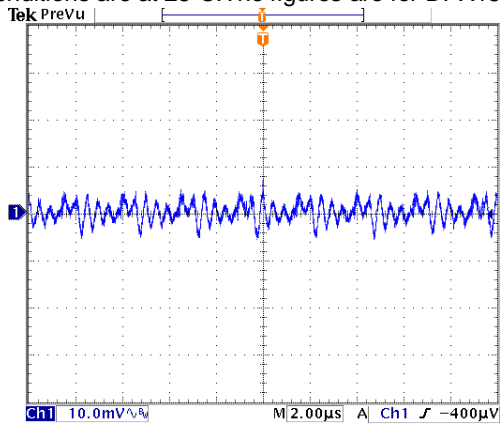

Typical Output Ripple and Noise.  
Vin(nom); Full Load

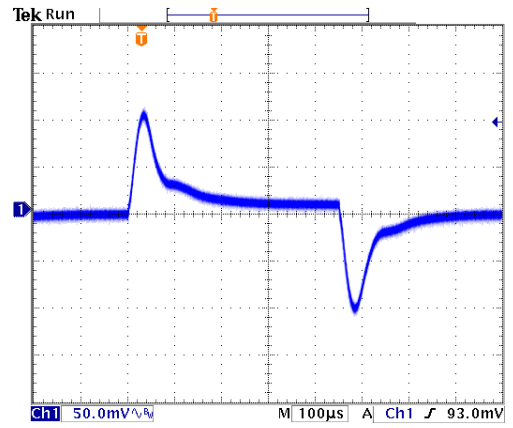

Transient Response to Dynamic Load Change from  
100% to 75% to 100% of Full Load; Vin(nom)

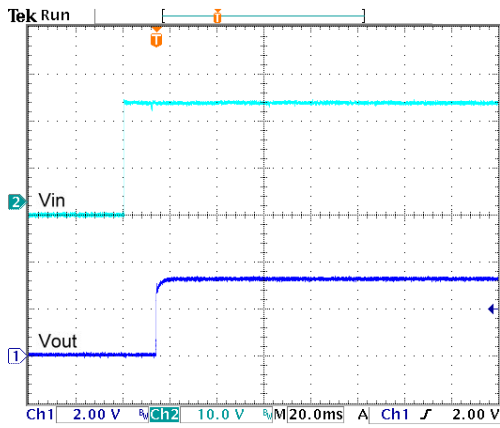

Typical Input Start-Up and Output Rise Characteristic  
Vin(nom); Full Load

### Characteristic Curves (Continued)

All test conditions are at 25°C. The figures are for DPX15-24WS05

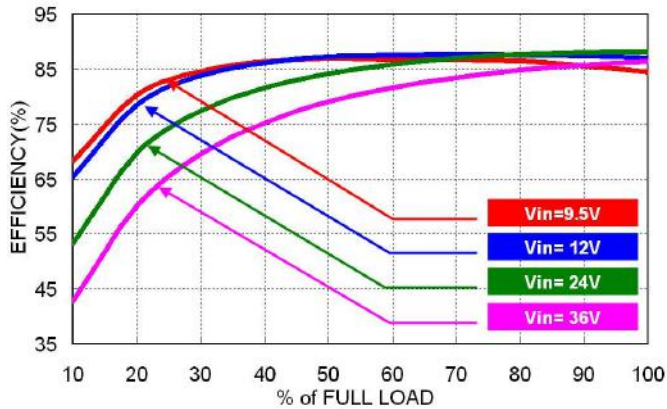

Efficiency versus Output Load

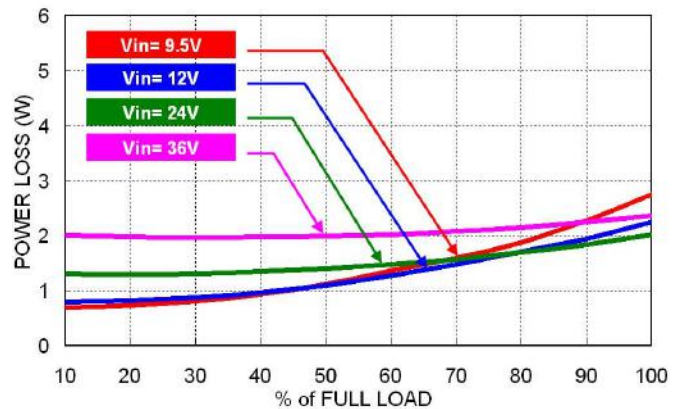

Power Dissipation versus Output Load

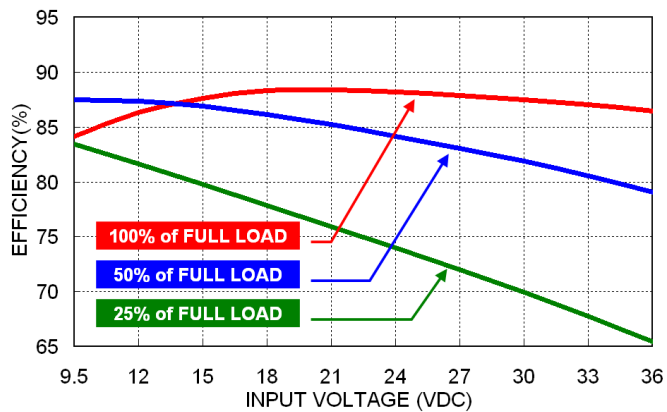

Efficiency versus Input Voltage

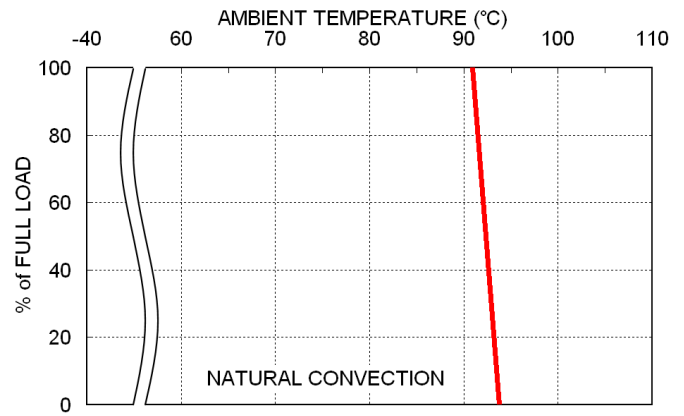

Derating Output Current versus Ambient Temperature and Airflow  
V<sub>in</sub>(nom)



### Characteristic Curves (Continued)

All test conditions are at 25°C. The figures are for DPX15-24WS05

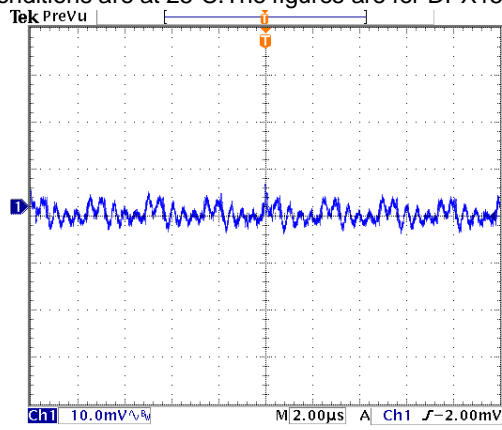

Typical Output Ripple and Noise.  
Vin(nom); Full Load

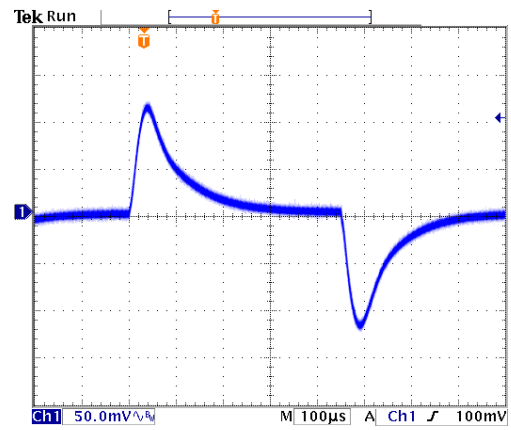

Transient Response to Dynamic Load Change from  
100% to 75% to 100% of Full Load; Vin(nom)

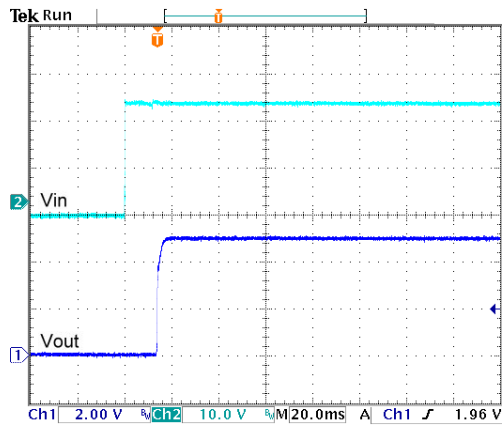

Typical Input Start-Up and Output Rise Characteristic  
Vin(nom); Full Load

### Characteristic Curves (Continued)

All test conditions are at 25°C. The figures are for DPX15-24WS5P1W

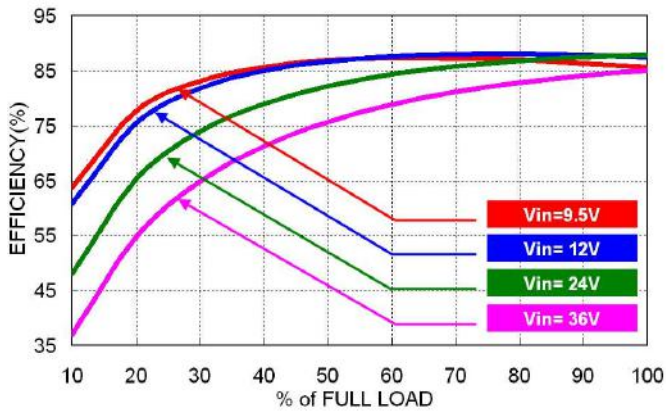

Efficiency versus Output Load

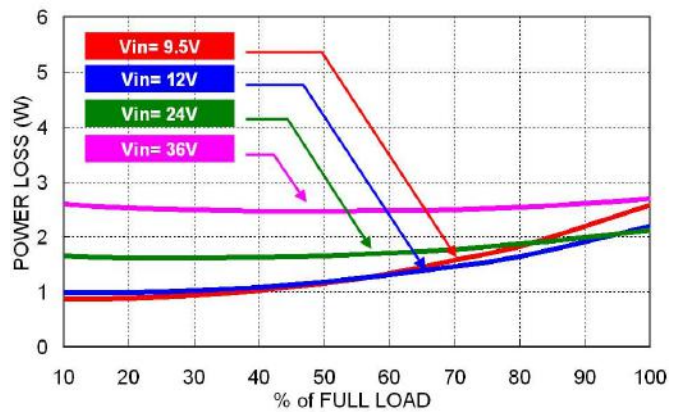

Power Dissipation versus Output Load

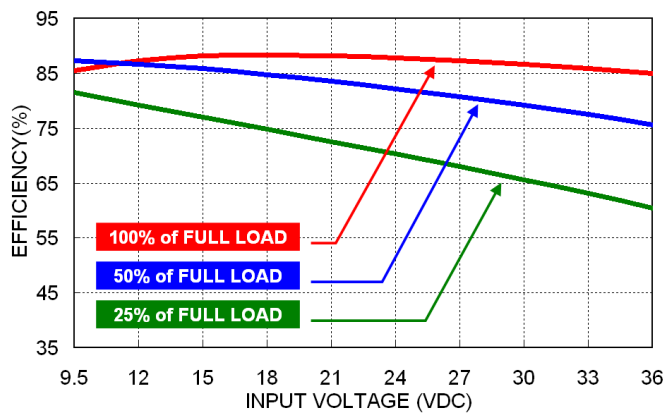

Efficiency versus Input Voltage

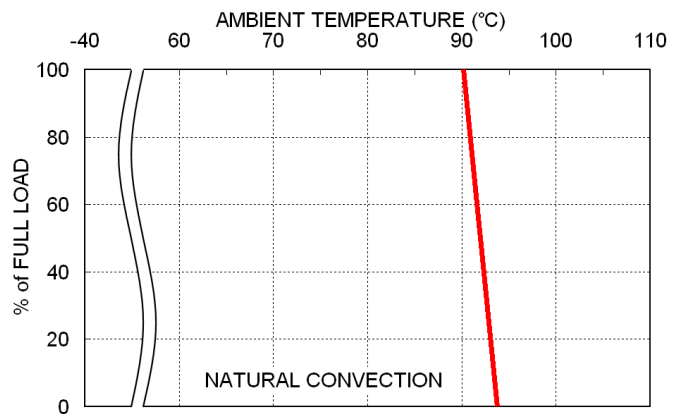

Derating Output Current versus Ambient Temperature and Airflow  
Vin(nom)

### Characteristic Curves (Continued)

All test conditions are at 25°C. The figures are for DPX15-24WS5P1

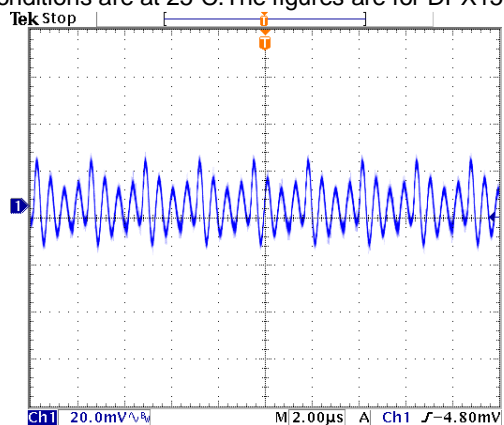

Typical Output Ripple and Noise.  
Vin(nom); Full Load

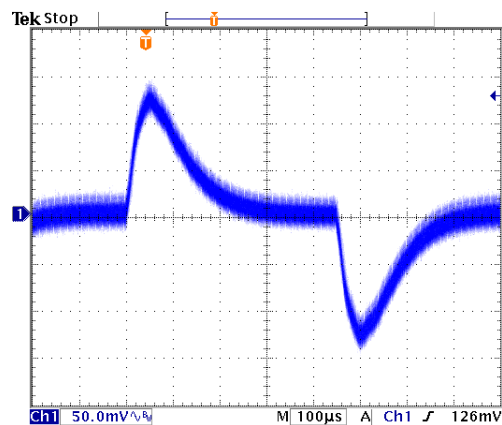

Transient Response to Dynamic Load Change from  
100% to 75% to 100% of Full Load; Vin(nom)

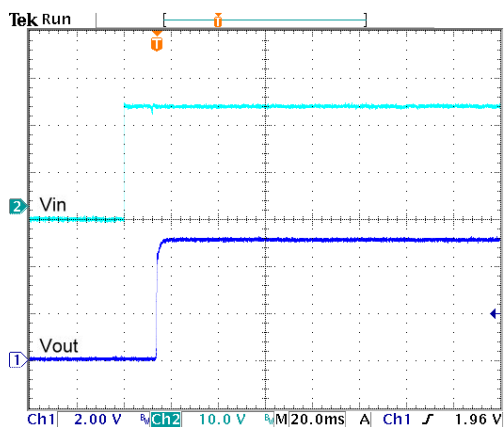

Typical Input Start-Up and Output Rise Characteristic  
Vin(nom); Full Load

### Characteristic Curves (Continued)

All test conditions are at 25°C. The figures are for DPX15-24WS12

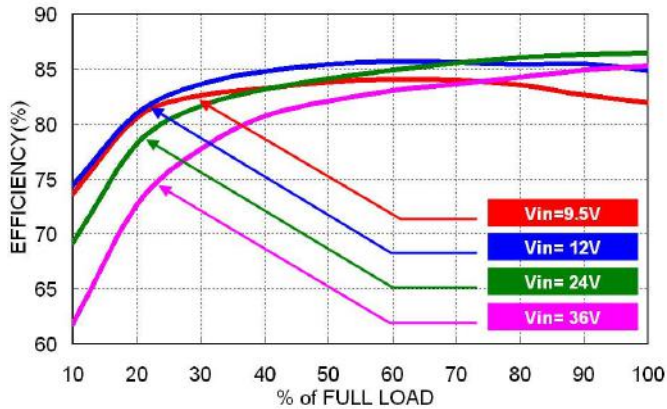

Efficiency versus Output Load

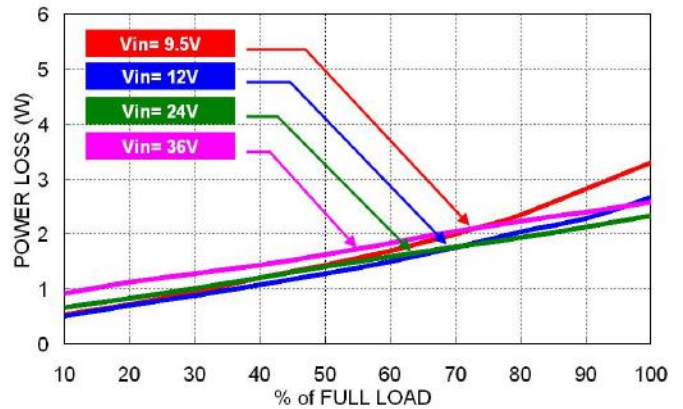

Power Dissipation versus Output Load

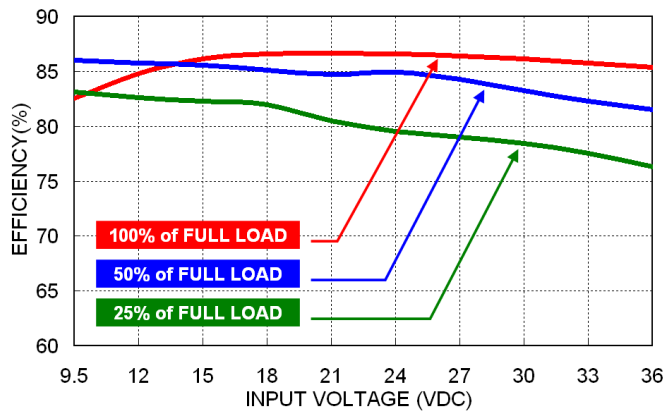

Efficiency versus Input Voltage

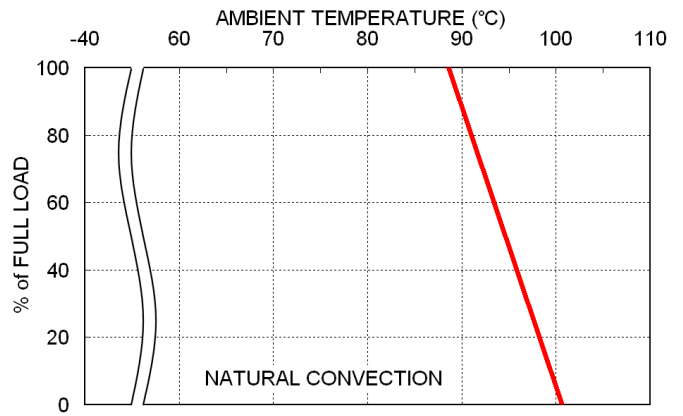

Derating Output Current versus Ambient Temperature and Airflow  
V<sub>in</sub>(nom)

### Characteristic Curves (Continued)

All test conditions are at 25°C. The figures are for DPX15-24WS12

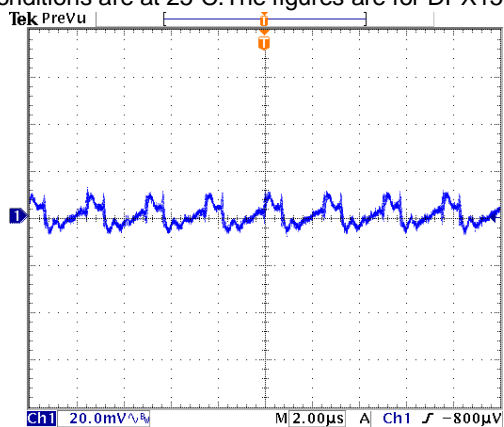

Typical Output Ripple and Noise.  
Vin(nom); Full Load

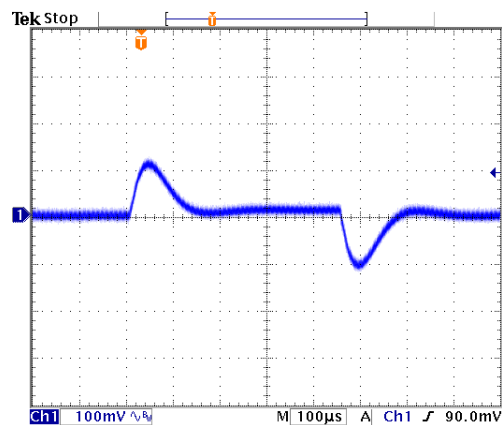

Transient Response to Dynamic Load Change from  
100% to 75% to 100% of Full Load; Vin(nom)

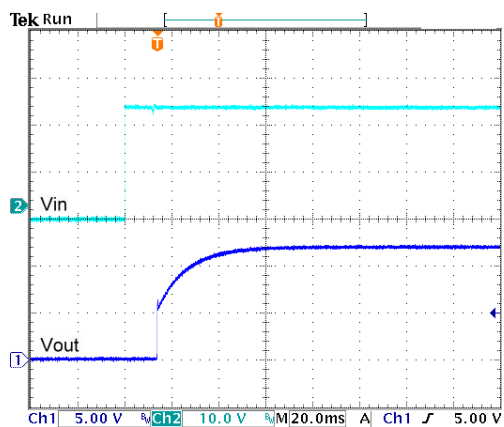

Typical Input Start-Up and Output Rise Characteristic  
Vin(nom); Full Load

### Characteristic Curves (Continued)

All test conditions are at 25°C. The figures are for DPX15-24WS15

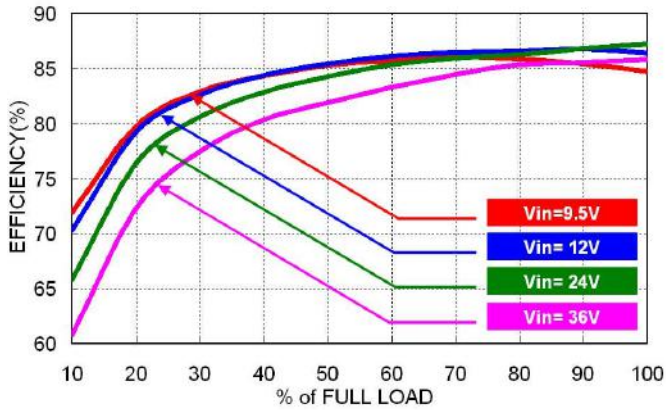

Efficiency versus Output Load

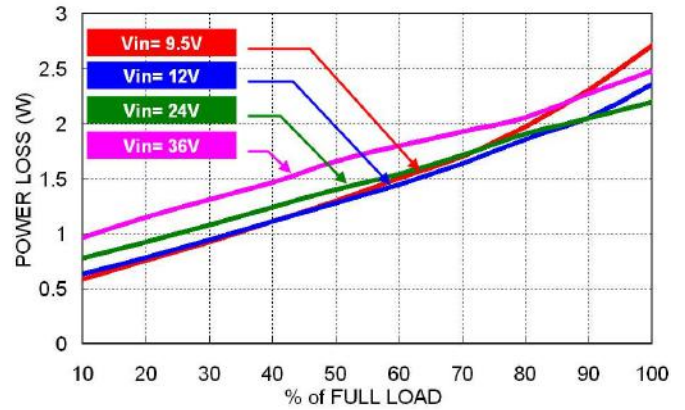

Power Dissipation versus Output Load

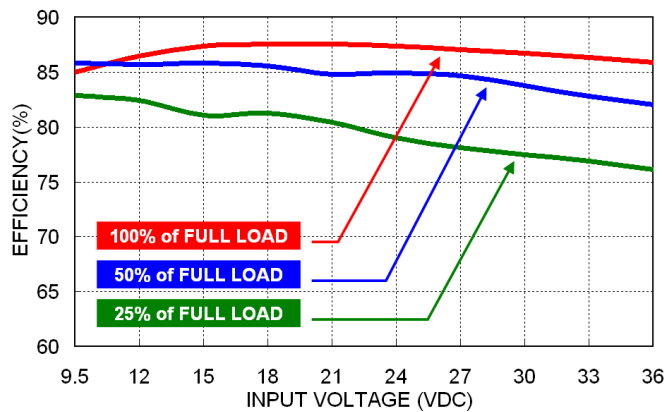

Efficiency versus Input Voltage

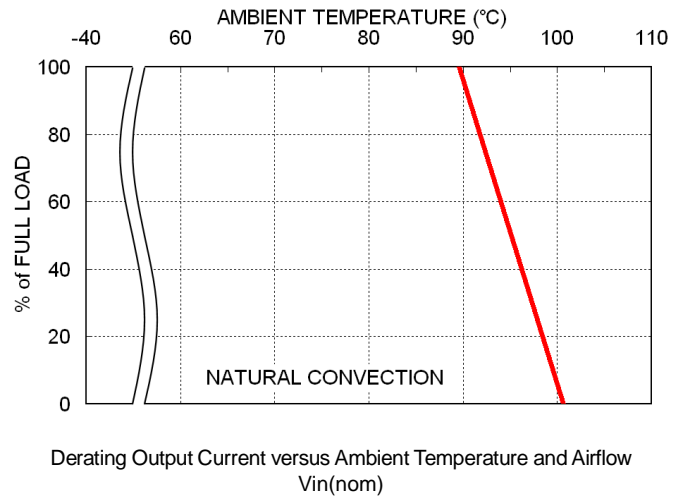

Derating Output Current versus Ambient Temperature and Airflow  
Vin(nom)

### Characteristic Curves (Continued)

All test conditions are at 25°C. The figures are for DPX15-24WS15

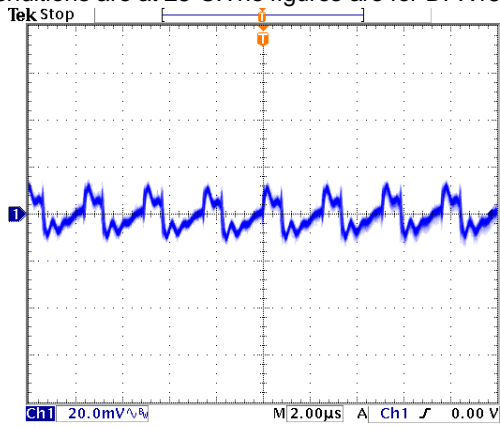

Typical Output Ripple and Noise.  
Vin(nom); Full Load

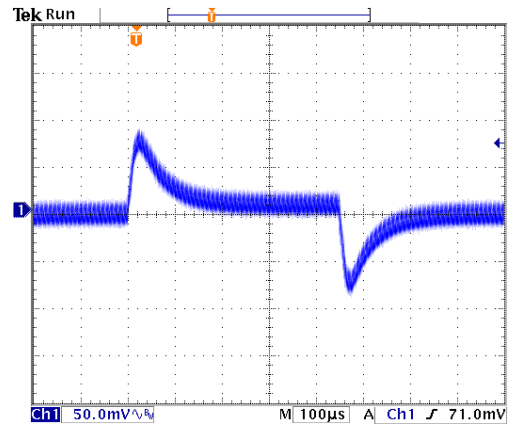

Transient Response to Dynamic Load Change from  
100% to 75% to 100% of Full Load; Vin(nom)

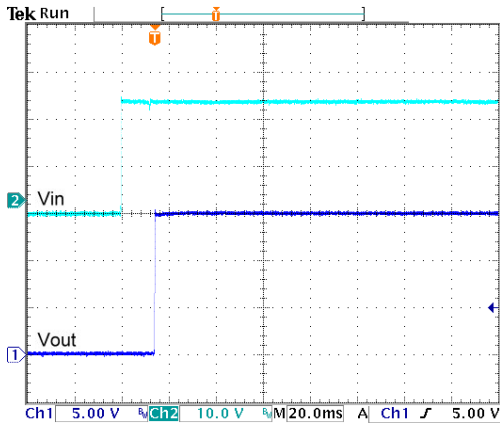

Typical Input Start-Up and Output Rise Characteristic  
Vin(nom); Full Load

### Characteristic Curves (Continued)

All test conditions are at 25°C. The figures are for DPX15-48WS3P3

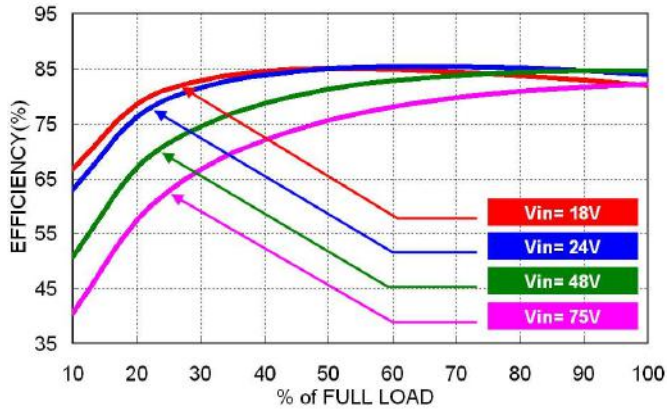

Efficiency versus Output Load

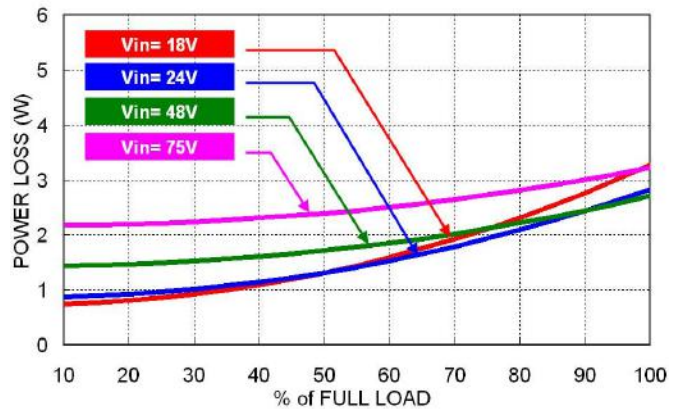

Power Dissipation versus Output Load

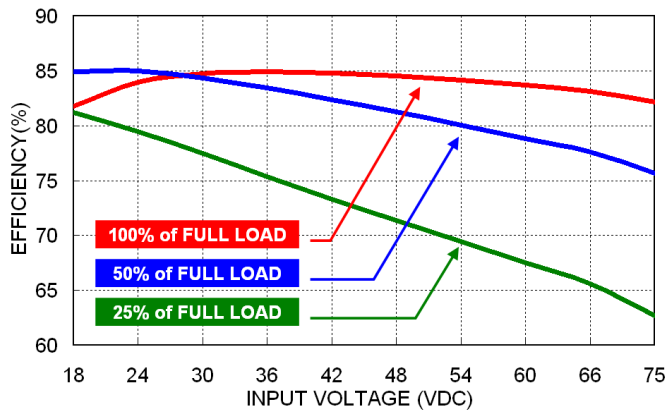

Efficiency versus Input Voltage

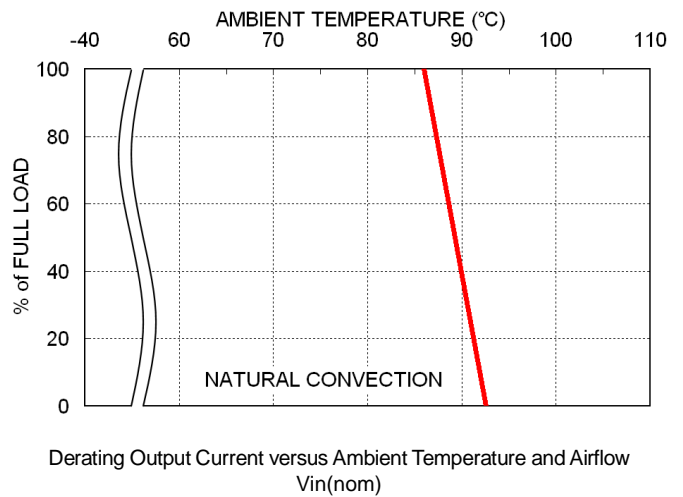

Derating Output Current versus Ambient Temperature and Airflow  
Vin(nom)



### Characteristic Curves (Continued)

All test conditions are at 25°C. The figures are for DPX15-48WS3P3

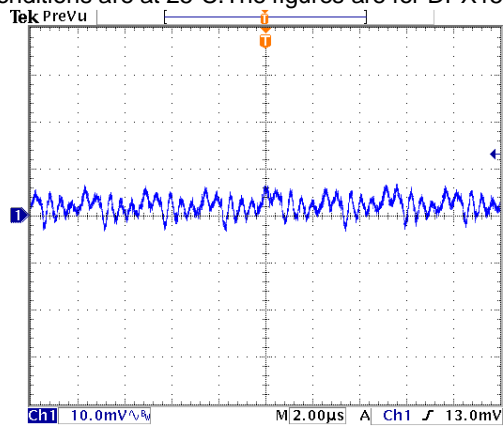

Typical Output Ripple and Noise.  
Vin(nom); Full Load

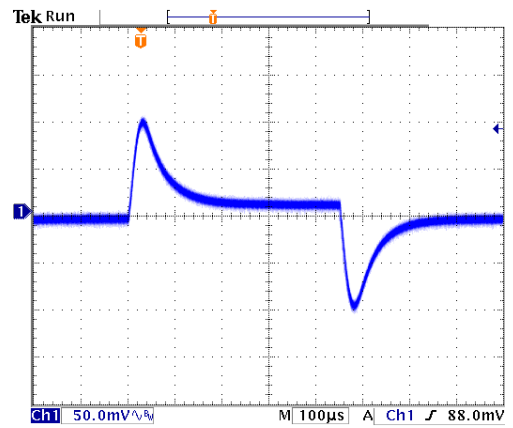

Transient Response to Dynamic Load Change from  
100% to 75% to 100% of Full Load; Vin(nom)

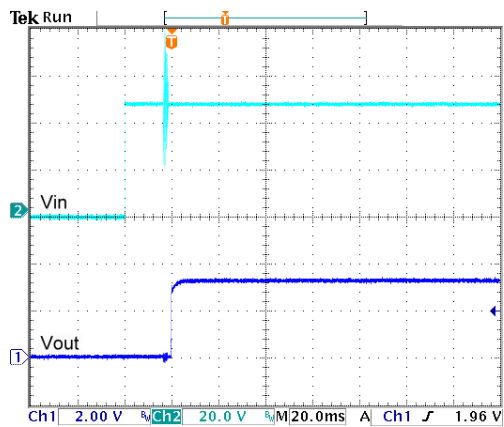

Typical Input Start-Up and Output Rise Characteristic  
Vin(nom); Full Load

### Characteristic Curves (Continued)

All test conditions are at 25°C. The figures are for DPX15-48WS05

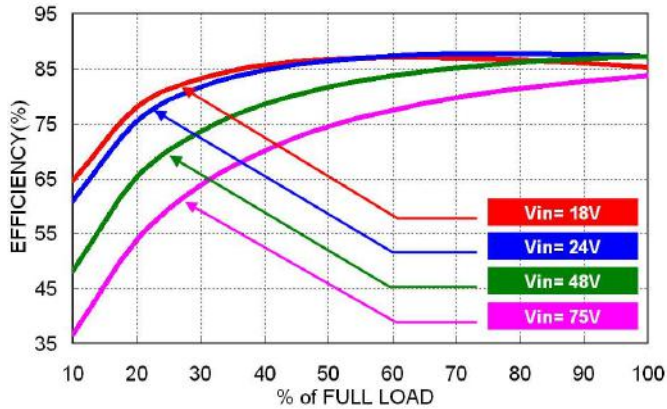

Efficiency versus Output Load

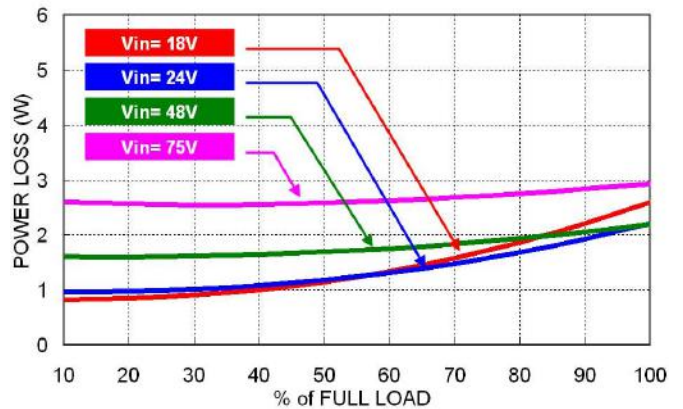

Power Dissipation versus Output Load

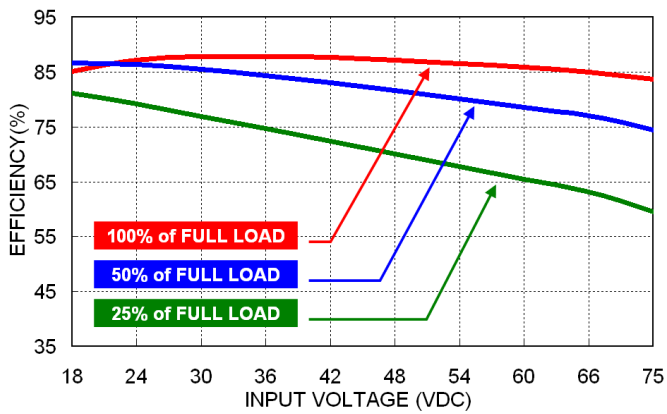

Efficiency versus Input Voltage

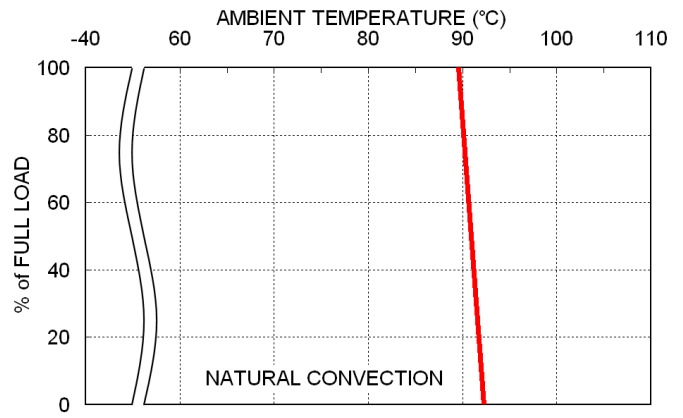

Derating Output Current versus Ambient Temperature and Airflow  
V<sub>in</sub>(nom)

### Characteristic Curves (Continued)

All test conditions are at 25°C. The figures are for DPX15-48WS05

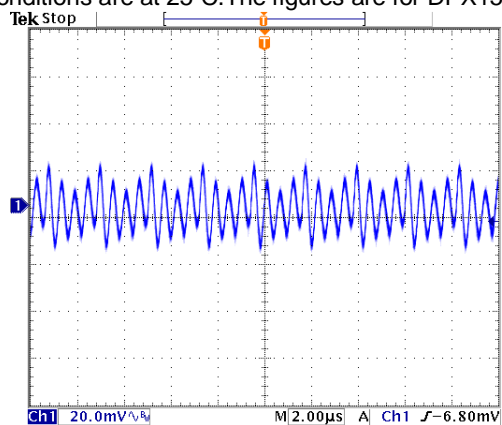

Typical Output Ripple and Noise.  
Vin(nom); Full Load

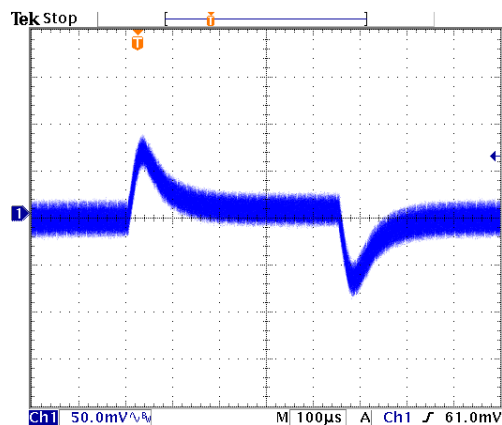

Transient Response to Dynamic Load Change from  
100% to 75% to 100% of Full Load; Vin(nom)

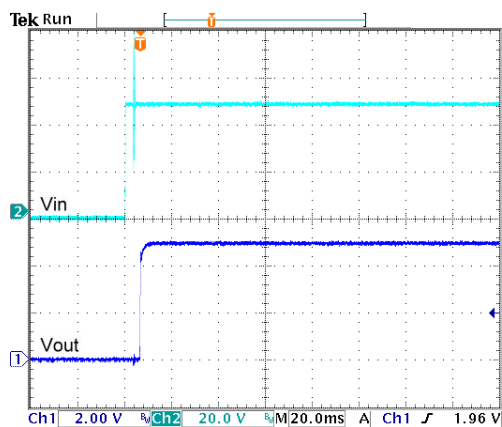

Typical Input Start-Up and Output Rise Characteristic  
Vin(nom); Full Load

### Characteristic Curves (Continued)

All test conditions are at 25°C. The figures are for DPX15-48WS5P1

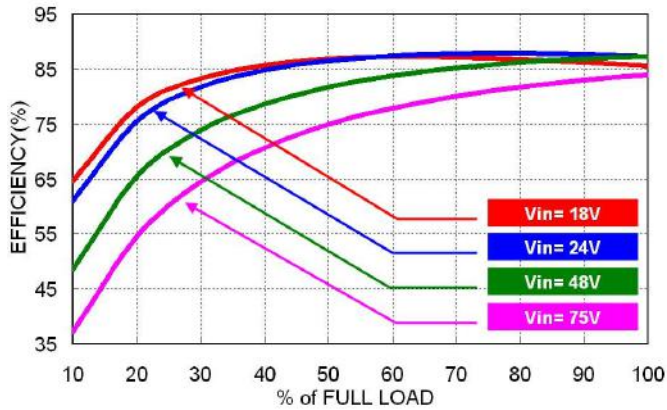

Efficiency versus Output Load

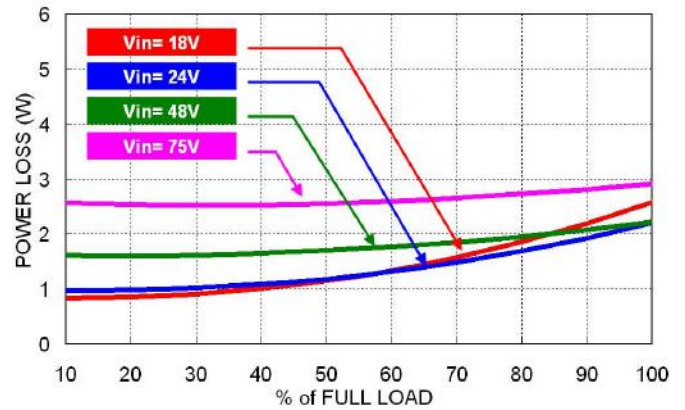

Power Dissipation versus Output Load

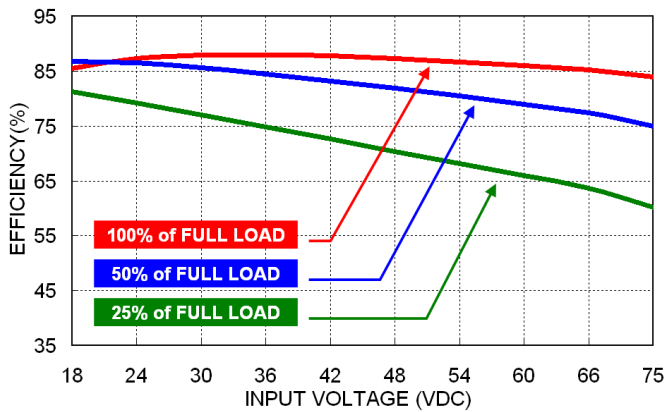

Efficiency versus Input Voltage

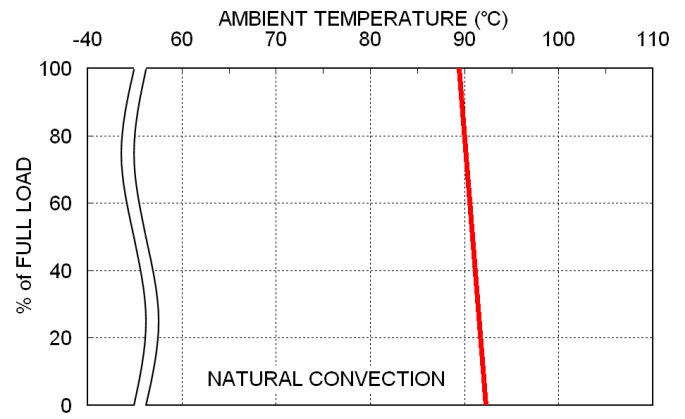

Derating Output Current versus Ambient Temperature and Airflow  
V<sub>in</sub>(nom)

### Characteristic Curves (Continued)

All test conditions are at 25°C. The figures are for DPX15-48WS5P1

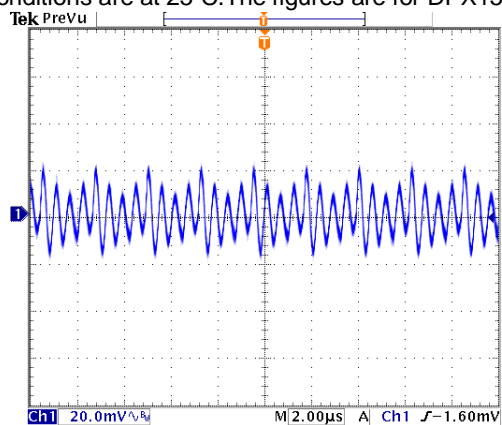

Typical Output Ripple and Noise.  
Vin(nom); Full Load

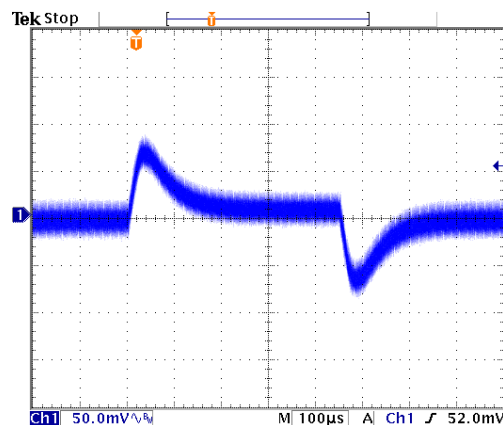

Transient Response to Dynamic Load Change from  
100% to 75% to 100% of Full Load; Vin(nom)

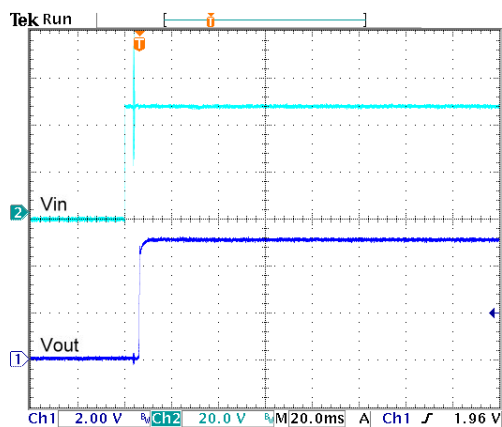

Typical Input Start-Up and Output Rise Characteristic  
Vin(nom); Full Load

### Characteristic Curves (Continued)

All test conditions are at 25°C. The figures are for DPX15-48WS12

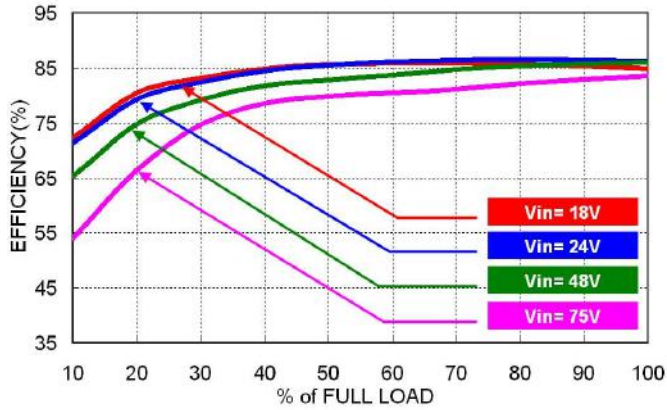

Efficiency versus Output Load

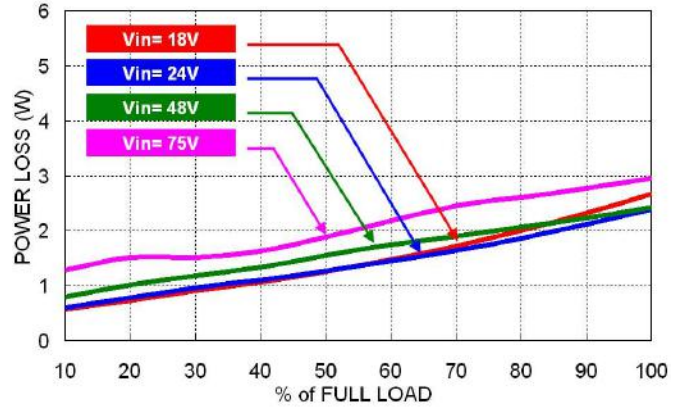

Power Dissipation versus Output Load

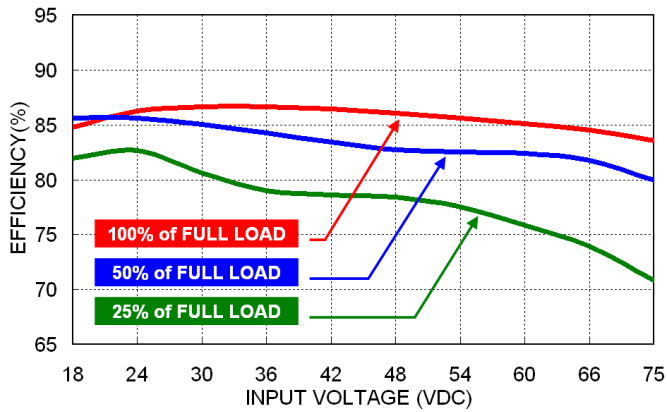

Efficiency versus Input Voltage

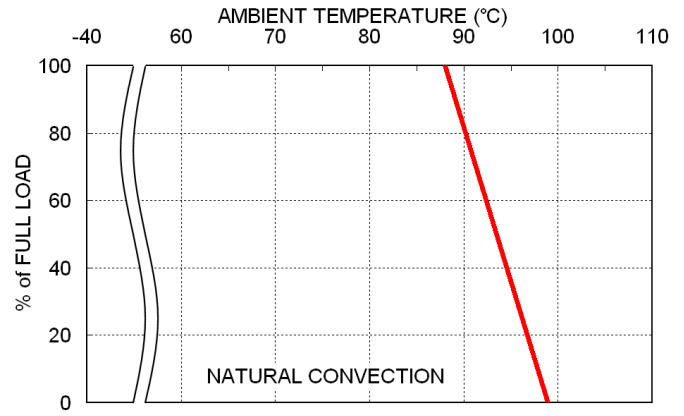

Derating Output Current versus Ambient Temperature and Airflow  
V<sub>in</sub>(nom)

### Characteristic Curves (Continued)

All test conditions are at 25°C. The figures are for DPX15-48WS12

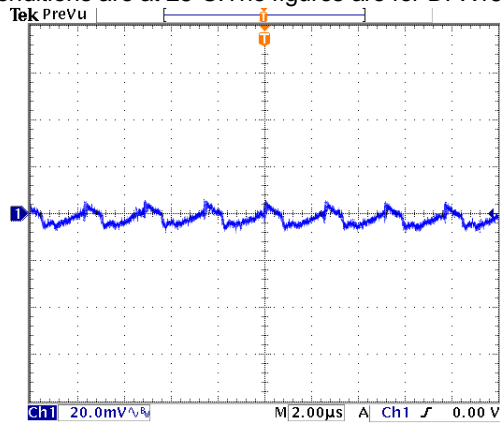

Typical Output Ripple and Noise.  
Vin(nom); Full Load

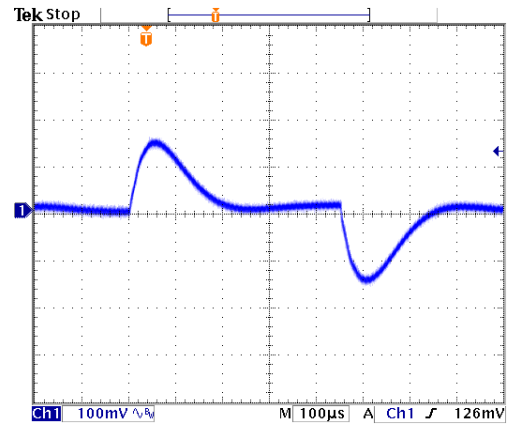

Transient Response to Dynamic Load Change from  
100% to 75% to 100% of Full Load; Vin(nom)

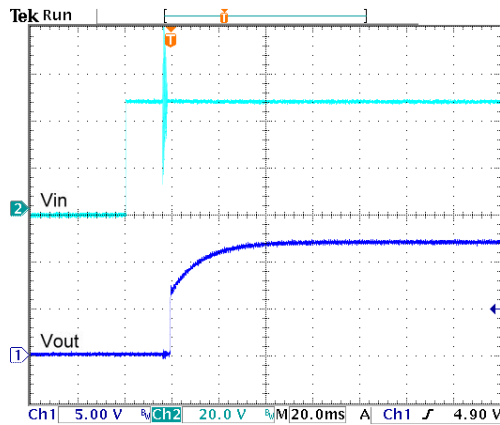

Typical Input Start-Up and Output Rise Characteristic  
Vin(nom); Full Load

### Characteristic Curves (Continued)

All test conditions are at 25°C. The figures are for DPX15-48WS15

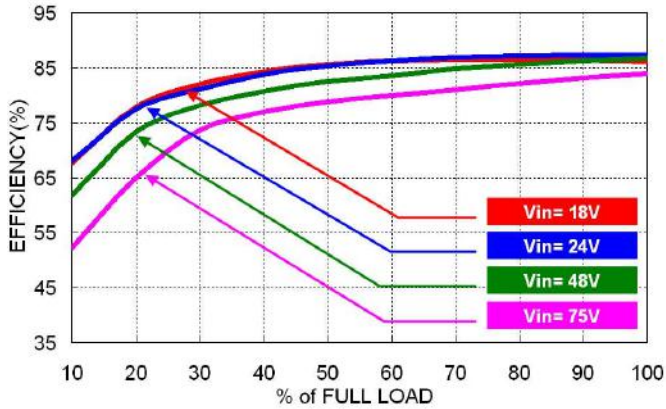

Efficiency versus Output Load

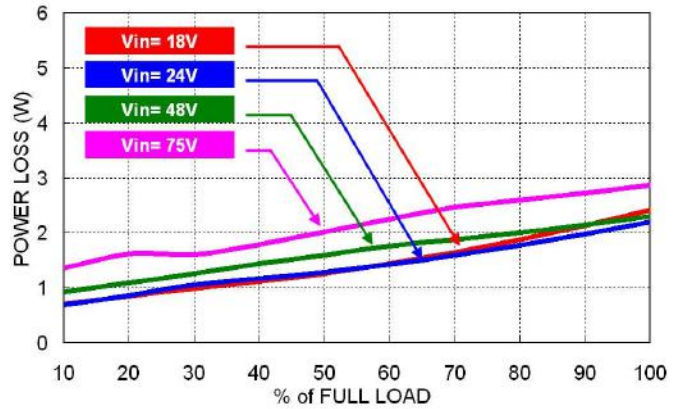

Power Dissipation versus Output Load

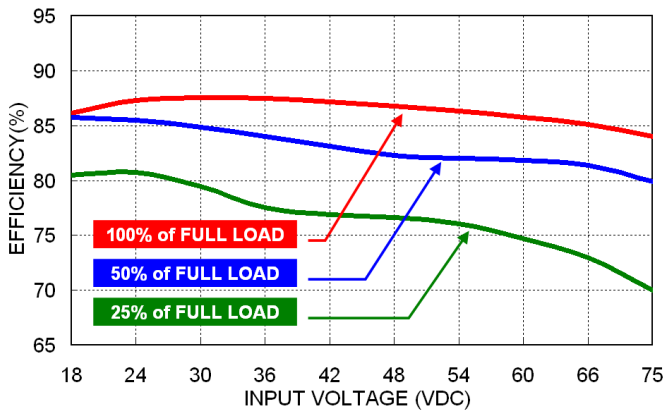

Efficiency versus Input Voltage

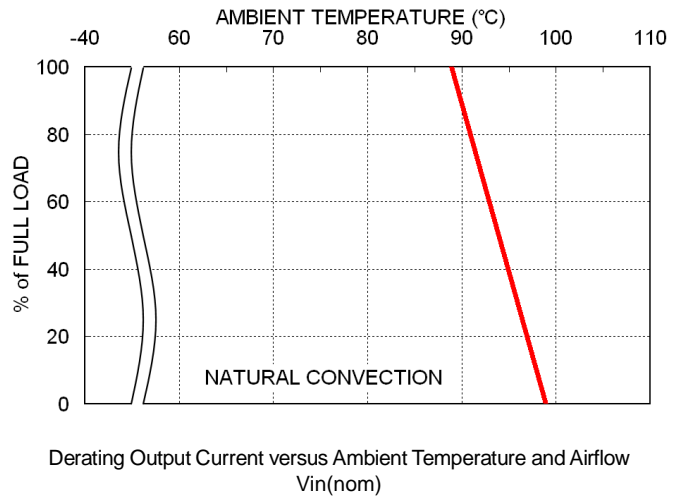

Derating Output Current versus Ambient Temperature and Airflow  
V<sub>in</sub>(nom)



### Characteristic Curves (Continued)

All test conditions are at 25°C. The figures are for DPX15-48WS15

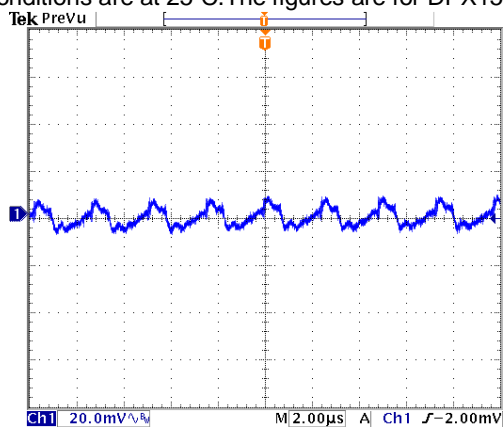

Typical Output Ripple and Noise.  
Vin(nom); Full Load

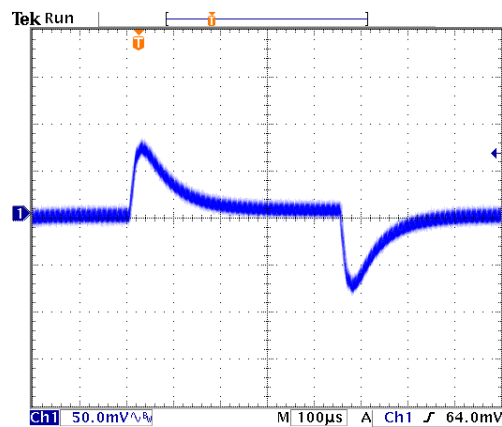

Transient Response to Dynamic Load Change from  
100% to 75% to 100% of Full Load; Vin(nom)

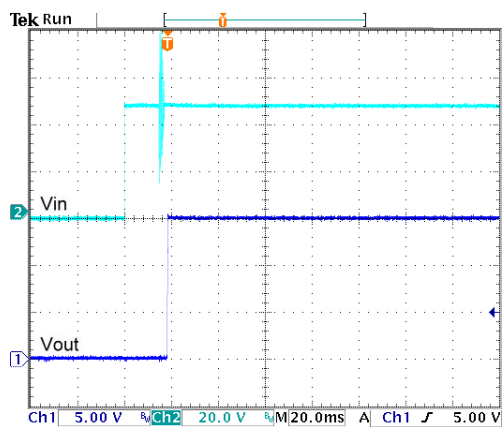

Typical Input Start-Up and Output Rise Characteristic  
Vin(nom); Full Load

### Input Source Impedance

The power module should be connected to a low impedance input source. Highly inductive source impedance can affect the stability of the power module. The test configuration for the input reflected-ripple current measurement is shown below:

#### Input reflected-ripple current measurement setup

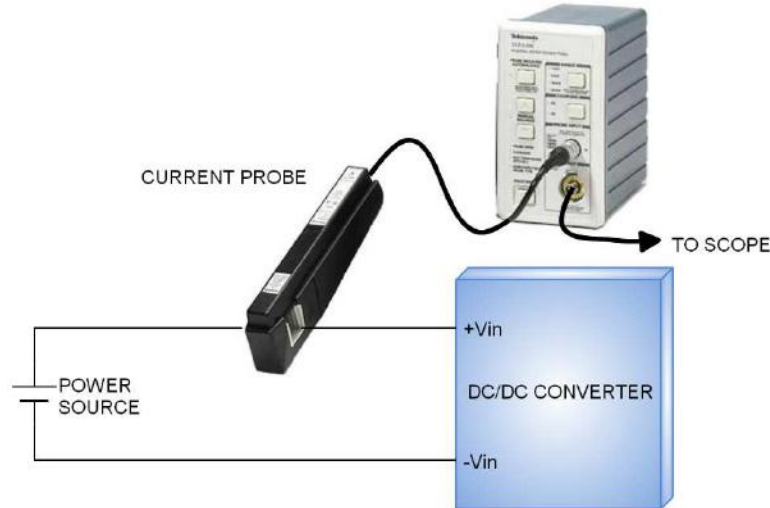

### Output Over Current Protection

When excessive output currents occur in the system, circuit protection is required on all power supplies. Normally, overload current is maintained at approximately 150 percent of rated current for DPX15-xxWSxx series.

Hiccup-mode is a method of operation in a power supply whose purpose is to protect the power supply from being damaged during an over-current fault condition. It also enables the power supply to restart when the fault is removed. There are other ways of protecting the power supply when it is over-loaded, such as the maximum current limiting or current fold-back methods.

One of the problems resulting from over current is that excessive heat may be generated in power devices; especially MOSFET and Schottky diodes and the temperature of those devices may exceed their specified limits. A protection mechanism has to be used to prevent those power devices from being damaged.

The operation of hiccup is as follows. When the current sense circuit sees an over-current event, the controller shuts off the power supply for a given time and then tries to start up the power supply again. If the over-load condition has been removed, the power supply will start up and operate normally; otherwise, the controller will see another over-current event and shut off the power supply again, repeating the previous cycle. Hiccup operation has none of the drawbacks of the other two protection methods, although its circuit is more complicated because it requires a timing circuit. The excess heat due to overload lasts for only a short duration in the hiccup cycle, hence the junction temperature of the power devices is much lower.

The hiccup operation can be done in various ways. For example, one can start hiccup operation any time an over-current event is detected; or prohibit hiccup during a designated start-up interval (usually a few milliseconds). The reason for the latter operation is that during start-up, the power supply needs to provide extra current to charge up the output capacitor. Thus the current demand during start-up is usually larger than during normal operation and it is easier for an over-current event to occur. If the power supply starts to hiccup once there is an over-current, it might never start up successfully. Hiccup mode protection will give the best protection for a power supply against over current situations, since it will limit the average current to the load at a low level, so reducing power dissipation and case temperature in the power devices.

### Output Short Circuit Protection

Continuous and auto-recovery mode.

During an output short circuit the converter shuts down. The average current during this condition will be very low.

### Output Over Voltage Protection

The output over-voltage protection consists of output Zener diode that monitors the voltage on the output terminals. If the voltage on the output terminals exceeds the over-voltage protection threshold, then the Zener diode clamps the output voltage.

### Remote On/off Control

The Ctrl Pin is used to turn the DC/DC power module on and off. The user must use a switch to control the logic voltage (high or low) level of the pin referenced to  $-V_{in}$ . The switch can be an open collector transistor, FET, or Photo-Coupler. The switch must be capable of sinking up to 1 mA at low-level logic voltage. A High-level logic of the Ctrl pin signal should be limited to a maximum voltage of 12V and a maximum current of 0.5 mA.

#### Remote ON/OFF Implementation

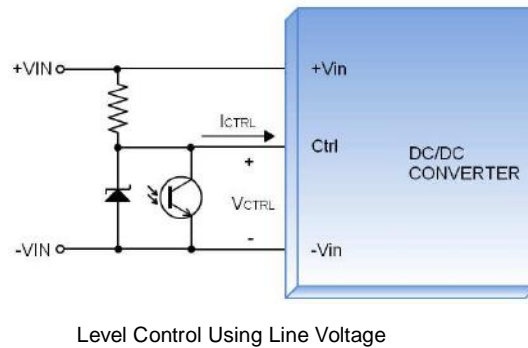
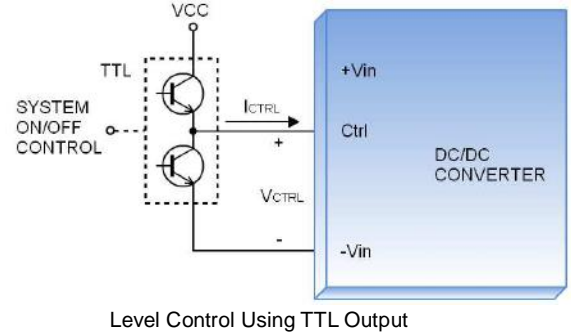
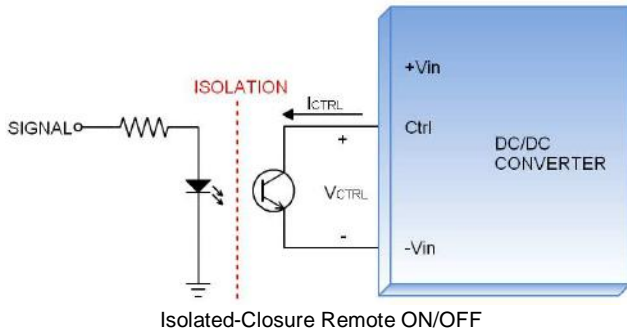

**There are two remote control options available, positive logic (optional) and negative logic (optional).**

a. The positive logic structure turns on the DC/DC module when the Ctrl pin is at a high-logic level and turns the module off using a low-logic level.

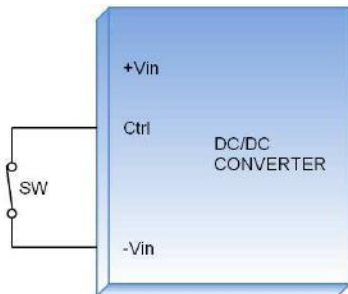

When DPX15-xxWSxx-P module is turned off using a Low-logic level

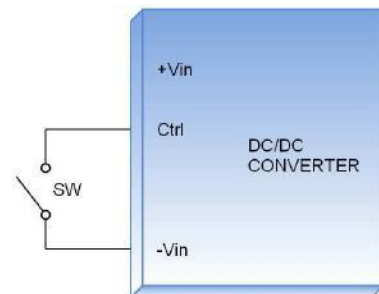

When DPX15-xxWSxx-P module is turned on using a High-logic level

b. The negative logic structure turns on the DC/DC module when the Ctrl pin is at a low-logic level and turns the module off when using a high-logic level.

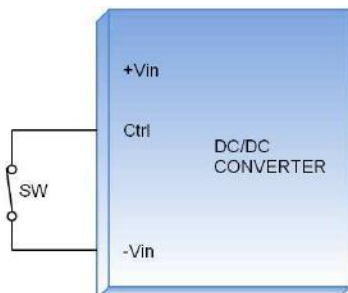

When DPX15-xxWSxx-N module is turned on using a Low-logic level

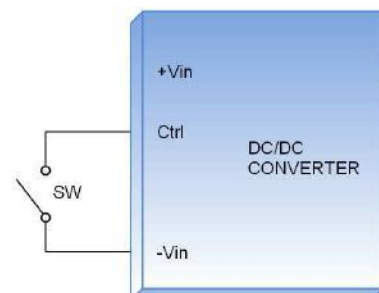

When DPX15-xxWSxx-N module is turned off using a High-logic level

### EMS Considerations

The DPX15-xxWSxx series can meet Fast Transient EN61000-4-4 and Surge EN61000-4-5 performance criteria A. Please see the following schematic:

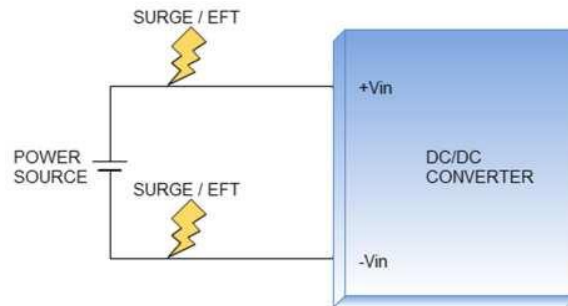

### Mechanical Data

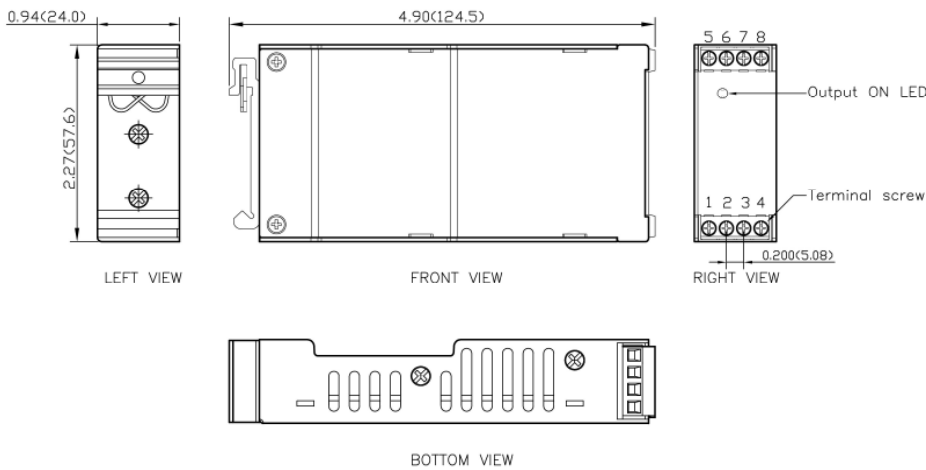

### PINOUT

| PIN | FUNCTION      |
|-----|---------------|
| 1   | Ctrl (Option) |
| 2   | -Vin          |
| 3   | -Vin          |
| 4   | +Vin          |
| 5   | NC            |
| 6   | -Vout         |
| 7   | +Vout         |
| 8   | NC            |

\* NC : No Connection

\* Screw terminals—wire range from 14 to 18 AWG

1. All dimensions in inch (mm)
2. Tolerance : X.XX±0.02 (X.X±0.5)  
X.XXX±0.01 (X.XX±0.25)
3. Terminal screw locked torque :  
MAX 2.5kgf-cm (0.25N-m)

### Packaging Information

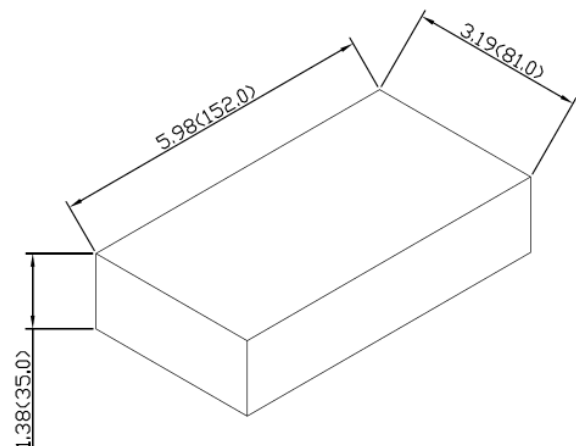
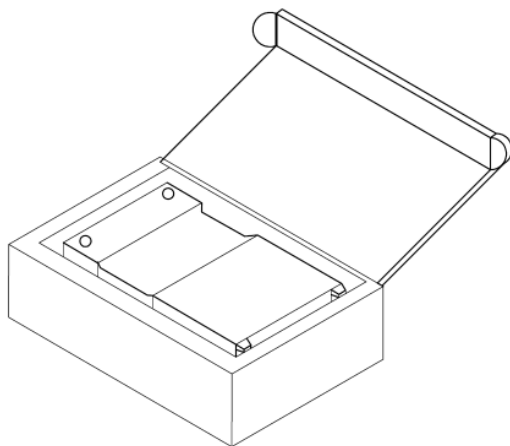

1PCS / BOX  
All dimensions in mm

### Part Number Structure

|                    |   |                            |                        |   |   |  |
|--------------------|---|----------------------------|------------------------|---|---|--|
| <b>DPX15</b>       | - | <b>48W</b>                 | <b>S</b>               | <b>05</b>   | - | <b>X</b>                               |
| <b>Series Name</b> |   | <b>Input Voltage (VDC)</b> | <b>Output Quantity</b> | <b>Output Voltage (VDC)</b>                       |   | <b>Remote Control Option</b>           |
|                    |   | 24: 9.5~36<br>48: 18~75    | S: Single              | 3P3: 3.3<br>05: 5<br>5P1: 5.1<br>12: 12<br>15: 15 |   | P: Positive logic<br>N: Negative logic |

| Model Number  | Input Range<br>VDC | Output Voltage<br>VDC | Output Current @ Full Load<br>A | Input Current @ No Load<br>mA | Efficiency<br>% | Maximum Capacitor Load<br>μF |
|---------------|--------------------|-----------------------|---------------------------------|-------------------------------|-----------------|------------------------------|
| DPX15-24WS3P3 | 9.5 ~ 36           | 3.3                   | 4.5                             | 52                            | 84              | 14700                        |
| DPX15-24WS05  | 9.5 ~ 36           | 5                     | 3                               | 67                            | 85              | 7200                         |
| DPX15-24WS5P1 | 9.5 ~ 36           | 5.1                   | 3                               | 67                            | 85              | 7200                         |
| DPX15-24WS12  | 9.5 ~ 36           | 12                    | 1.25                            | 26                            | 85              | 1250                         |
| DPX15-24WS15  | 9.5 ~ 36           | 15                    | 1                               | 26                            | 85              | 800                          |
| DPX15-48WS3P3 | 18 ~ 75            | 3.3                   | 4.5                             | 37                            | 84              | 14700                        |
| DPX15-48WS05  | 18 ~ 75            | 5                     | 3                               | 38                            | 86              | 7200                         |
| DPX15-48WS5P1 | 18 ~ 75            | 5.1                   | 3                               | 38                            | 86              | 7200                         |
| DPX15-48WS12  | 18 ~ 75            | 12                    | 1.25                            | 18                            | 85              | 1250                         |
| DPX15-48WS15  | 18 ~ 75            | 15                    | 1                               | 18                            | 85              | 800                          |

### MTBF and Reliability

The MTBF for DPX15-xxWSxx series of DC/DC converters has been calculated using MIL-HDBK-217F @ full load, operating temperature at 25°C. The resulting figure for MTBF is  $1.681 \times 10^6$  hours.