

PXC-M06xxW Single Output Series: DC-DC Converter Module

9 ~ 36 VDC and 18~ 75 VDC input; 3.3 to 24 VDC Single Output
6 Watts Output Power



FEATURES

- SINGLE OUTPUT UP TO 1.8A
- REINFORCED INSULATION FOR 250VAC WORKING VOLTAGE
- CLEARANCE AND CREEPAGE DISTANCE :8.0mm/2MOPP
- 5000VAC INPUT TO OUTPUT 2MOPP ISOLATION
- NO MINIMUM LOAD REQUIRED
- HIGH EFFICIENCY UP TO 89%
- BUILT-IN EMI CLASS A FILTER
- 2 μ A PATIENT LEAKAGE CURRENT
- SMALL SIZE: 1.25 \times 0.80 \times 0.41 INCH
- 4:1 ULTRA WIDE INPUT VOLTAGE RANGE
- FIXED SWITCHING FREQUENCY
- INPUT UNDER-VOLTAGE PROTECTION
- OUTPUT OVER-VOLTAGE PROTECTION
- OVER-CURRENT PROTECTION
- OUTPUT SHORT CIRCUIT PROTECTION
- REMOTE ON/OFF
- COMPLIANT TO RoHS 10 & REACH



CE and UKCA MARKED

SAFETY APPROVALS: ANSI/AAMI ES60601-1
EN60601-1
IEC60601-1

APPLICATIONS

- MEDICAL EQUIPMENT
- TELECOM/DATACOM
- INDUSTRY CONTROL SYSTEM
- MEASUREMENT EQUIPMENT
- SEMICONDUCTOR EQUIPMENT
- PV POWER SYSTEM
- IGBT GATE DRIVER

OPTIONS

- PIN CONNECTION
- REMOTE ON/OFF
- TRIM

GENERAL DESCRIPTIONS

The PXC-M06W series offer 6 watts of output power from a 1.25 x 0.80 x 0.41 inch package. PXC-M06W series have 4:1 wide input voltage of 9~36VDC and 18~75VDC. The PXC-M06W has features 5000VAC of isolation, short circuit protection, over-current protection and over-voltage protection. All models are particularly suited to IGBT isolated power supplies, measurement equipment, telecommunications, industrial and medical equipment applications.

Contents

Output Specifications	3
Input Specifications	4
General Specifications	5
Environmental Specifications	5
EMC Characteristics	5
Characteristic Curves	
PXC-M06-24WS3P3	6
PXC-M06-24WS05	8
PXC-M06-24WS12	10
PXC-M06-24WS15	12
PXC-M06-24WS24	14
PXC-M06-48WS3P3	16
PXC-M06-48WS05	18
PXC-M06-48WS12	20
PXC-M06-48WS15	22
PXC-M06-48WS24	24
Output Voltage Adjustment	26
Input Source Impedance	27
Output Over Current Protection	28
Output Short Circuitry Protection	28
Output Over Voltage Protection	28
Thermal Considerations	28
Remote On/Off Control	29
EMS Considerations	30
Mechanical Data	31
Recommended Pad Layout	32
Soldering Considerations	32
Packaging Information	33
Part Number Structure	33
Safety and Installation Instruction	33
MTBF and Reliability	33

Output Specifications

Parameter	Model	Min	Typ	Max	Unit
Output Voltage (Vin(nom); Full Load; Ta=25°C)	xxWS3P3	3.267	3.3	3.333	VDC
	xxWS05	4.95	5	5.05	
	xxWS12	11.88	12	12.12	
	xxWS15	14.85	15	15.15	
	xxWS24	23.76	24	24.24	
Output Regulation Line (Vin(min) to Vin(max); Full Load) Load (0% to 100% of Full Load)	All	-0.2		+0.2	%
		-0.2		+0.2	
Output Ripple and Noise Peak to Peak (20MHz Bandwidth) With a 10µF/25V X7R MLCC	xxWS3P3		30	75	mVp-p
	xxWS05		30	75	
	xxWS12		40	100	
	xxWS15		40	100	
	xxWS24		50	100	
Voltage adjustability (see page 26) (Only for B-type Pin connection option)	xxWS3P3- I	-10		+10	% of Vout
	xxWS05- I	-10		+10	
	xxWS12- I	-10		+10	
	xxWS15- I	-10		+20	
	xxWS24- I	-10		+20	
Temperature Coefficient	All	-0.02		+0.02	%/°C
Output Voltage Overshoot (Vin,min to Vin,max; Full Load; Ta=25°C)	All		0	3	% of Vout
Dynamic Load Response (Vin= Vin(nom); Ta=25°C) Load step change from 75% to 100% or 100 to 75% of Full Load Peak Deviation Setting Time (Vo < 10% peak deviation)	All		3		% of Vout µs
	All		250		
Output Current	xxWS3P3	0		1800	mA
	xxWS05	0		1200	
	xxWS12	0		500	
	xxWS15	0		400	
	xxWS24	0		250	
Output Capacitance Load	xxWS3P3			2100	µF
	xxWS05			1500	
	xxWS12			260	
	xxWS15			210	
	xxWS24			75	
Output Over Voltage Protection (see page 28)	xxWS3P3	3.7		5	VDC
	xxWS05	5.6		7.0	
	xxWS12	13.5		16	
	xxWS15	18.3		22.0	
	xxWS24	29.1		34.5	
Output Over Current Protection (see page 28) (% of Iout rated; Hiccup mode)	All		150		% of FL
Output Short Circuit Protection (see page 28)	All		Continuous, automatic recovery		

Input Specifications

Parameter	Model	Min	Typ	Max	Unit		
Operating Input Voltage	Continuous	24WSxx	9	24	36	VDC	
		48WSxx	18	48	75		
	Transient (3sec,max)	24WSxx			50		
		48WSxx			100		
Input Standby Current (Typ. value at Vin(nom); No Load)	24WS3P3		6		mA		
	24WS05		6				
	24WS12		6				
	24WS15		6				
	24WS24		6				
	48WS3P3		4				
	48WS05		4				
	48WS12		4				
	48WS15		4				
	48WS24		4				
Under Voltage Lockout Turn-on Threshold	24WSxx			9	VDC		
	48WSxx			18			
Under Voltage Lockout Turn-off Threshold	24WSxx		8		VDC		
	48WSxx		16				
Input reflected ripple current (5 to 20MHz, 12μH source impedance)	All		20		mAp-p		
Start Up Time (Vin(nom) and constant resistive load)	All				ms		
						Power up	30
						Remote ON/OFF	30
Remote ON/OFF Control Type B (see page 29) (The Ctrl pin voltage is referenced to negative input) Ctrl pin Low Voltage, Module ON Ctrl pin High Voltage, Module OFF	xxWSxx- P			Short or 0 ~ 1.2VDC Open or 2.2 ~ 12VDC			
Input Current of Remote Control Pin		-0.5		1	mA		
Remote Off State Input Current			2.5		mA		

General Specifications

Parameter	Model	Min	Typ	Max	Unit
Efficiency (Vin(nom); Full Load; Ta=25°C)	24WS3P3		83		%
	24WS05		86		
	24WS12		89		
	24WS15		89		
	24WS24		88.5		
	48WS3P3		82.5		
	48WS05		86.5		
	48WS12		88		
	48WS15		88.5		
48WS24		88			
Isolation voltage (1 minute) Input to Output	All	5000			VAC
Isolation capacitance	All		12	17	pF
Leakage current (240VAC,60Hz)	All			2	μA
Switching Frequency	All	225	250	275	kHz
Clearance/Creepage	All	8			mm
Weight	All		14.0		g
MTBF (see page 33) MIL-HDBK-217F Ta=25°C, Full load	All		3.849 x 10 ⁶		hours
Safety Approvals	All		ANSI/AAMI ES60601-1 IEC60601-1, EN60601-1		
Case Material			Non-conductive black plastic		
Base Material	All		Non-conductive black plastic		
Potting Material	All		Silicone (UL94 V-0)		

Environmental Specifications

Parameter	Model	Min	Typ	Max	Unit
Operating Ambient Temperature	All	Without Derating	-40	88	°C
		With Derating	88	105	
Storage Temperature	All	-55		125	°C
Thermal Impedance (20LFM)	All		18		°C/W
Relative humidity	All	5		95	% RH
Thermal Shock	All		MIL-STD-810F		
Vibration	All		MIL-STD-810F		

EMC Characteristics

Characteristic	Standard	Condition	Level
EMI	EN55011 EN55032 FCC Part 18	Module stand-alone	Class A
	EN55011 EN55032 FCC Part 18	With external input filter	Class B
ESD	EN61000-4-2	Air Contact ±8kV ±6kV	Perf. Criteria A
Radiated Immunity	EN61000-4-3	10V/m	Perf. Criteria A
Fast Transient (see page 30)	EN61000-4-4	±2kV	Perf. Criteria A
Surge (see page 30)	EN61000-4-5	±2kV	Perf. Criteria A
Conducted Immunity	EN61000-4-6	10V r.m.s	Perf. Criteria A

Characteristic Curves

All test conditions are at 25°C. The figures are for PXC-M06-24WS3P3

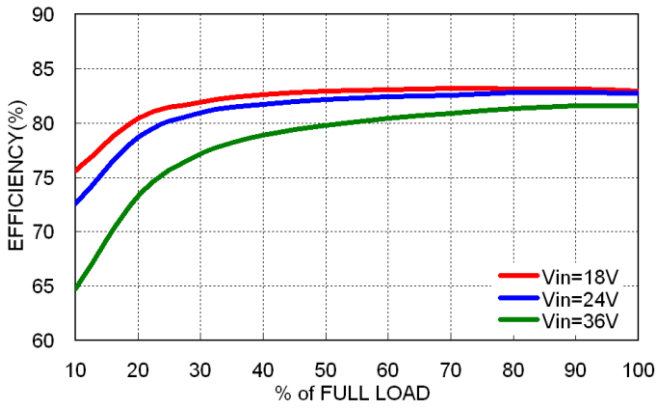

Efficiency versus Output Current

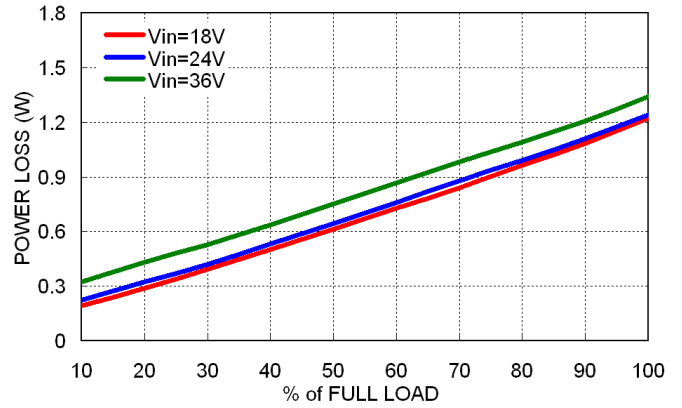

Power Dissipation versus Output Current

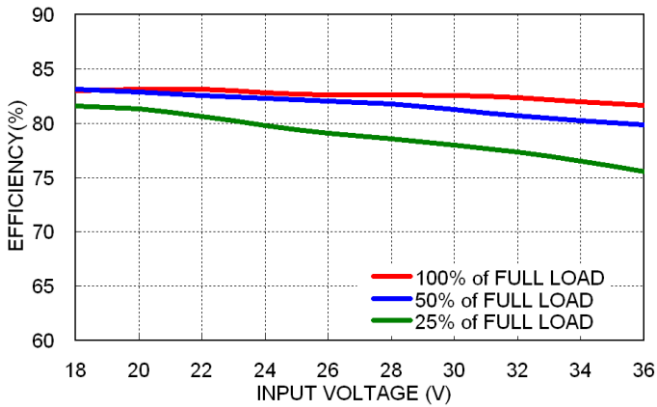

Efficiency versus Input Voltage Full Load

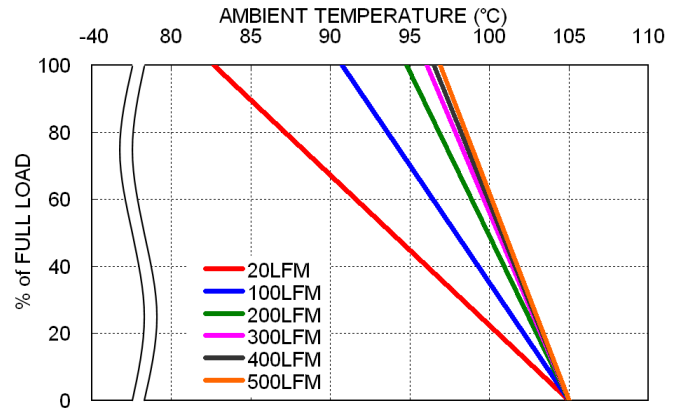

Derating Output Current versus Ambient Temperature and Airflow Vin(nom)

Characteristic Curves (Continued)

All test conditions are at 25°C. The figures are for PXC-M06-24WS3P3

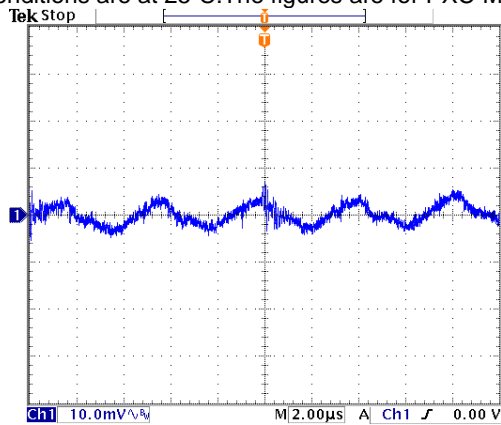

Typical Output Ripple and Noise.
Vin(nom); Full Load

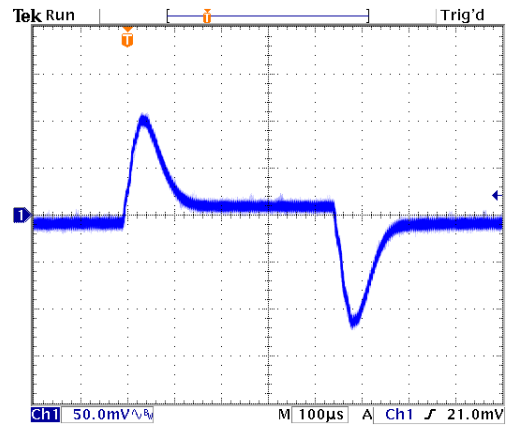

Transient Response to Dynamic Load Change from
100% to 75% to 100% of Full Load; Vin(nom)

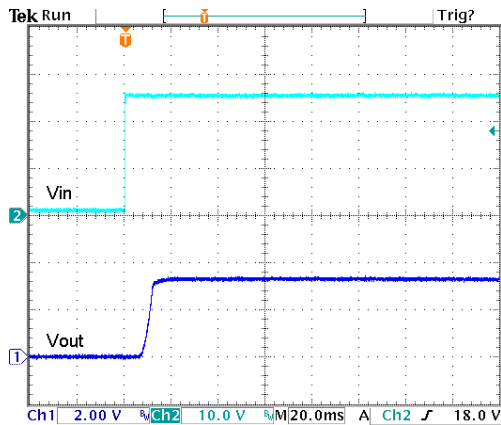

Typical Input Start-Up and Output Rise Characteristic
Vin(nom); Full Load

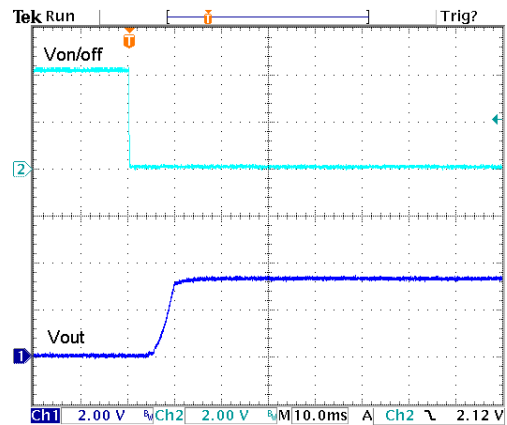

Using ON/OFF Voltage Start-Up and Output Rise Characteristic
Vin(nom); Full Load

Characteristic Curves (Continued)

All test conditions are at 25°C. The figures are for PXC-M06-24WS05

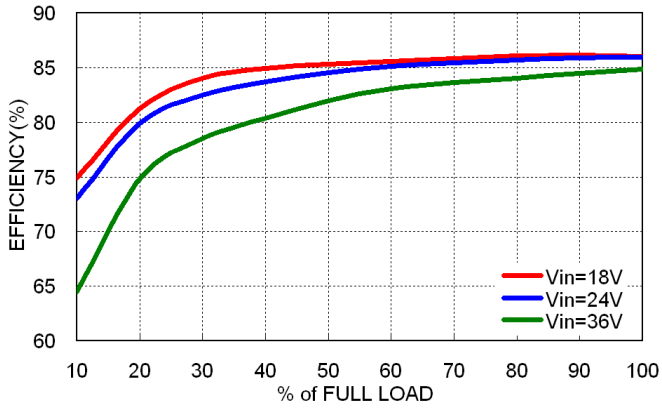

Efficiency versus Output Current

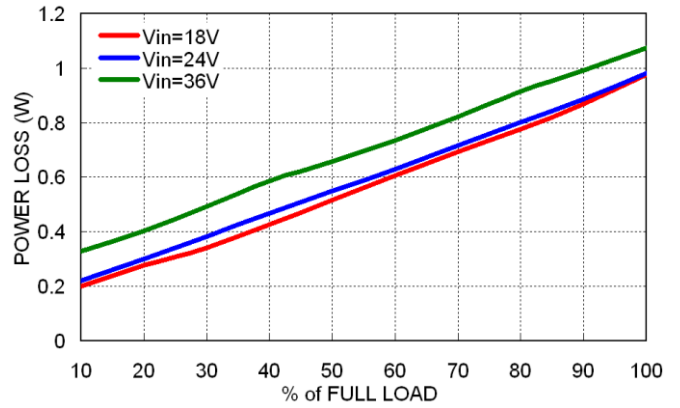

Power Dissipation versus Output Current

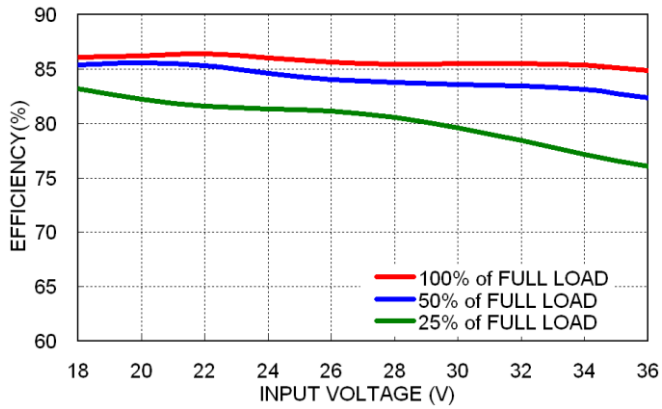

Efficiency versus Input Voltage Full Load

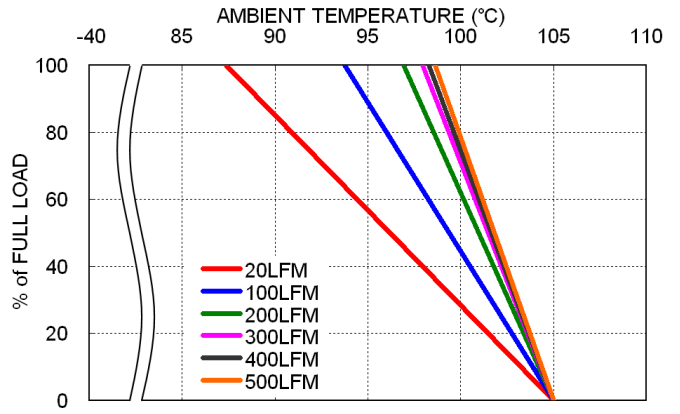

Derating Output Current versus Ambient Temperature and Airflow Vin(nom)

Characteristic Curves (Continued)

All test conditions are at 25°C. The figures are for PXC-M06-24WS05

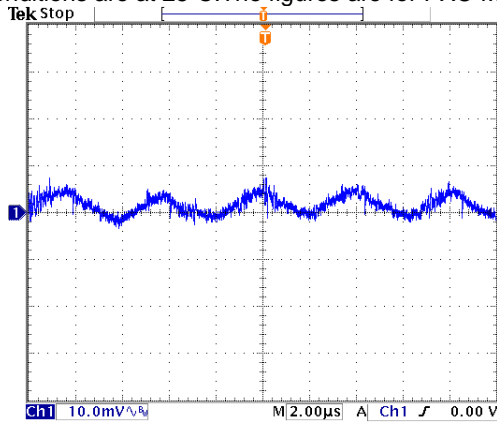

Typical Output Ripple and Noise.
Vin(nom); Full Load

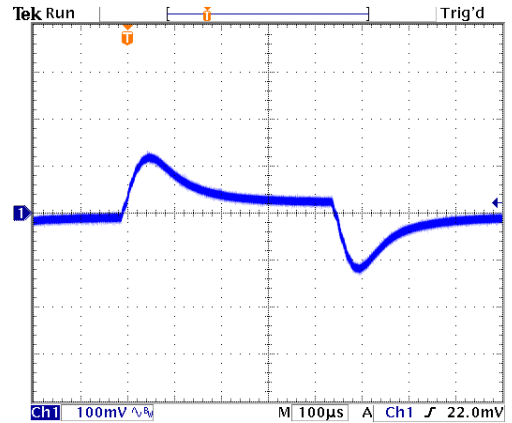

Transient Response to Dynamic Load Change from 100% to 75% to 100% of Full Load; Vin(nom)

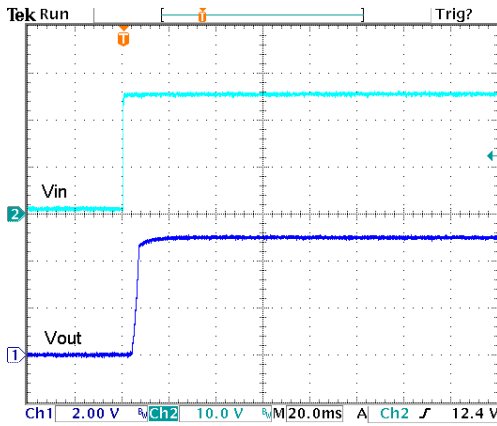

Typical Input Start-Up and Output Rise Characteristic
Vin(nom); Full Load

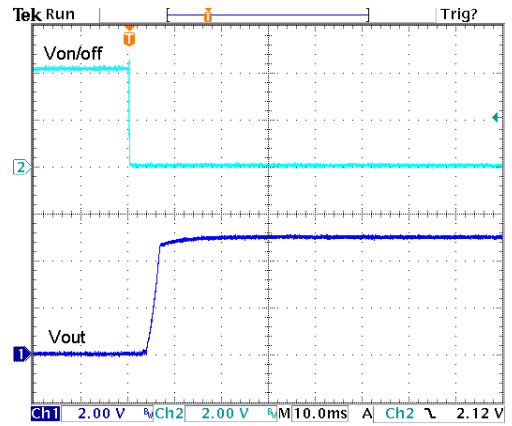

Using ON/OFF Voltage Start-Up and Output Rise Characteristic
Vin(nom); Full Load

Characteristic Curves (Continued)

All test conditions are at 25°C. The figures are for PXC-M06-24WS12

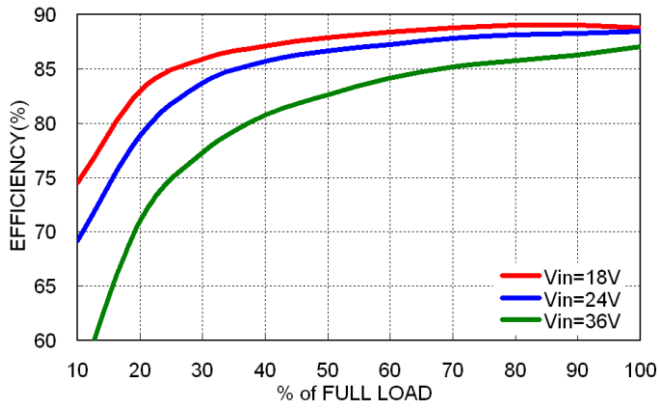

Efficiency versus Output Current

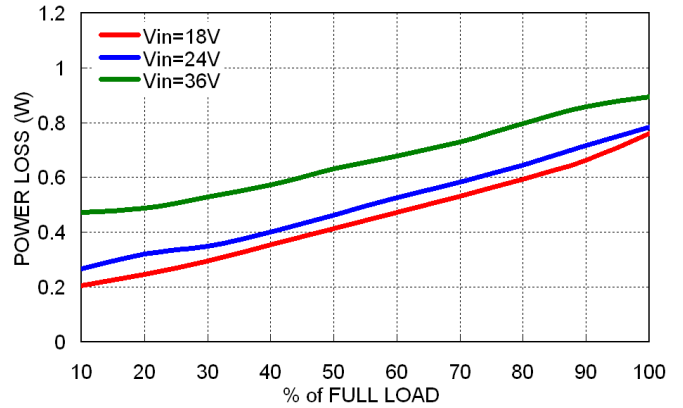

Power Dissipation versus Output Current

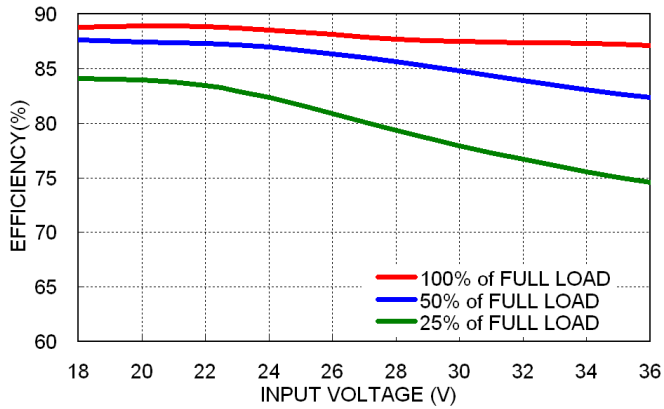

Efficiency versus Input Voltage Full Load

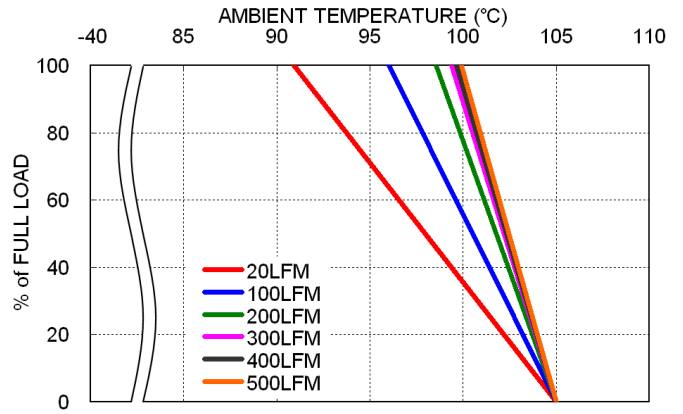

Derating Output Current versus Ambient Temperature and Airflow Vin(nom)

Characteristic Curves (Continued)

All test conditions are at 25°C. The figures are for PXC-M06-24WS12

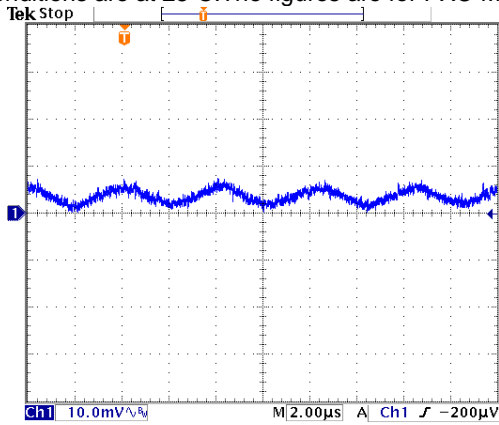

Typical Output Ripple and Noise.
Vin(nom); Full Load

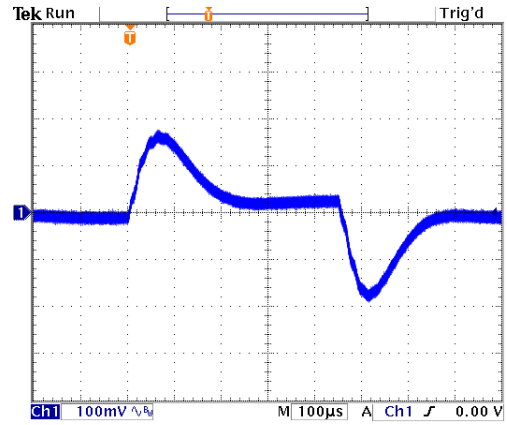

Transient Response to Dynamic Load Change from 100% to 75% to 100% of Full Load; Vin(nom)

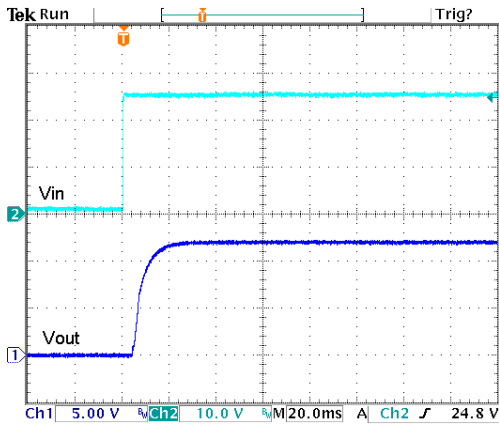

Typical Input Start-Up and Output Rise Characteristic
Vin(nom); Full Load

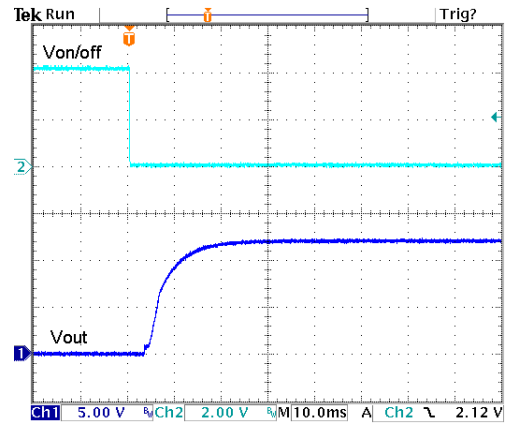

Using ON/OFF Voltage Start-Up and Output Rise Characteristic
Vin(nom); Full Load

Characteristic Curves (Continued)

All test conditions are at 25°C. The figures are for PXC-M06-24WS15

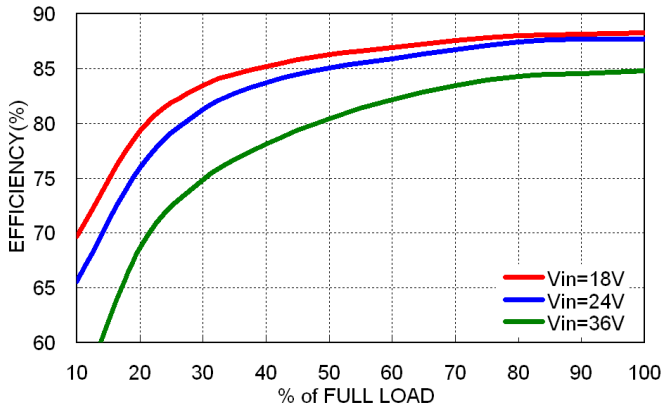

Efficiency versus Output Current

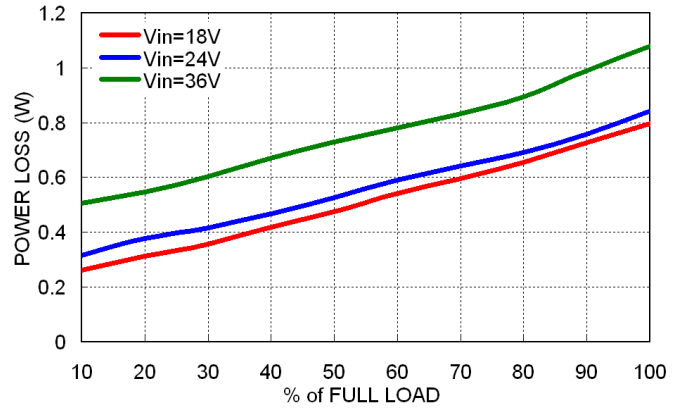

Power Dissipation versus Output Current

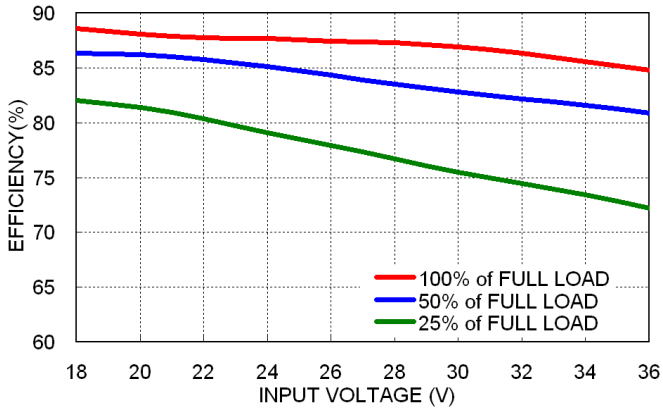

Efficiency versus Input Voltage Full Load

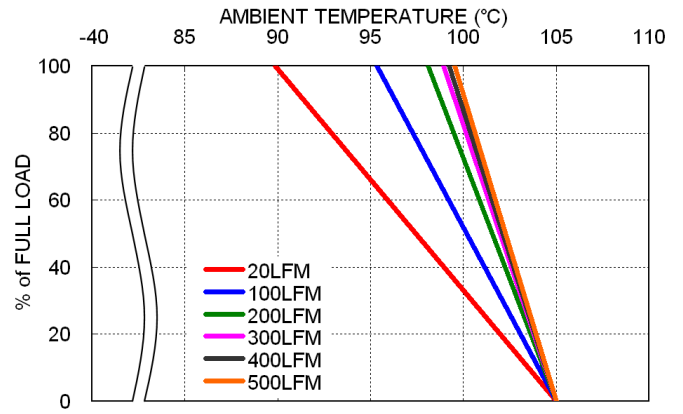

Derating Output Current versus Ambient Temperature and Airflow Vin(nom)

Characteristic Curves (Continued)

All test conditions are at 25°C. The figures are for PXC-M06-24WS15

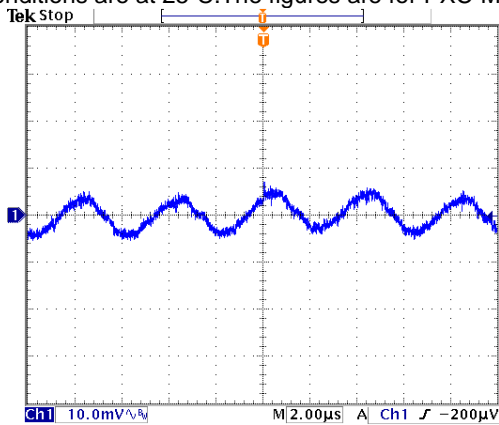

Typical Output Ripple and Noise.
Vin(nom); Full Load

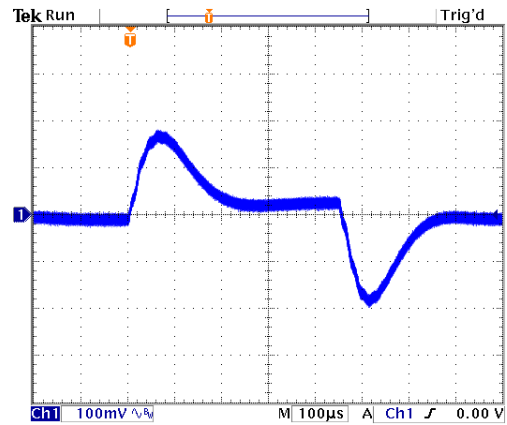

Transient Response to Dynamic Load Change from
100% to 75% to 100% of Full Load; Vin(nom)

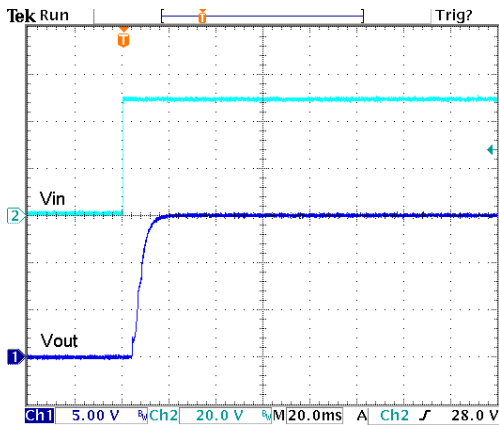

Typical Input Start-Up and Output Rise Characteristic
Vin(nom); Full Load

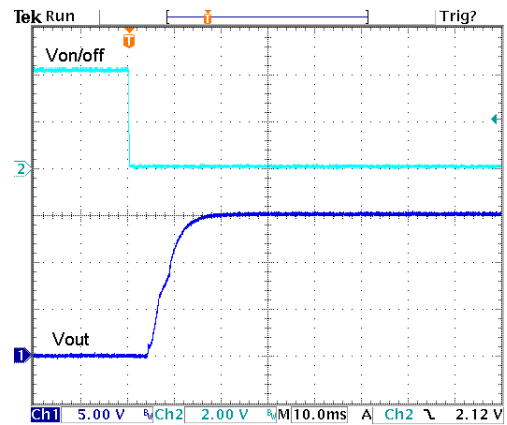

Using ON/OFF Voltage Start-Up and Output Rise Characteristic
Vin(nom); Full Load

Characteristic Curves (Continued)

All test conditions are at 25°C. The figures are for PXC-M06-24WS24

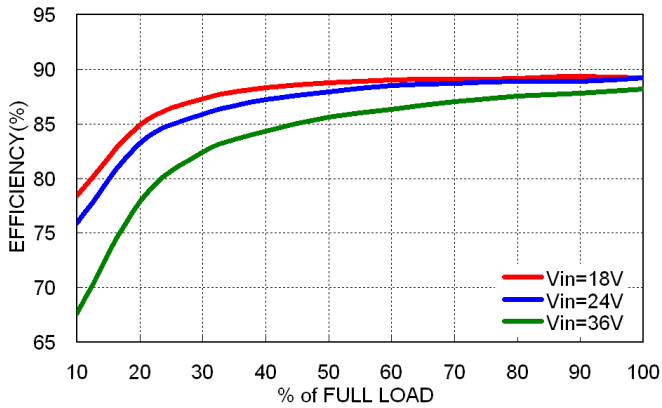

Efficiency versus Output Current

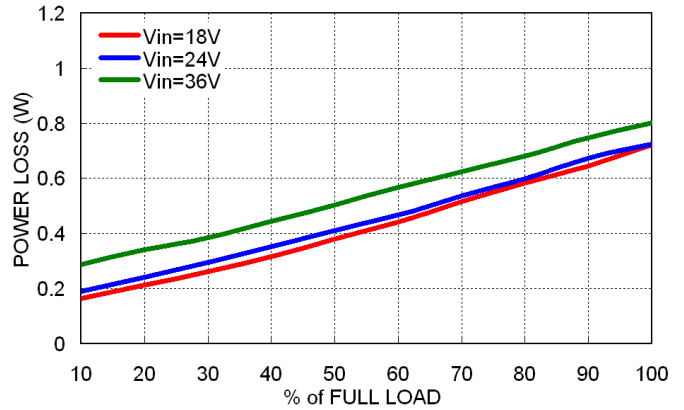

Power Dissipation versus Output Current

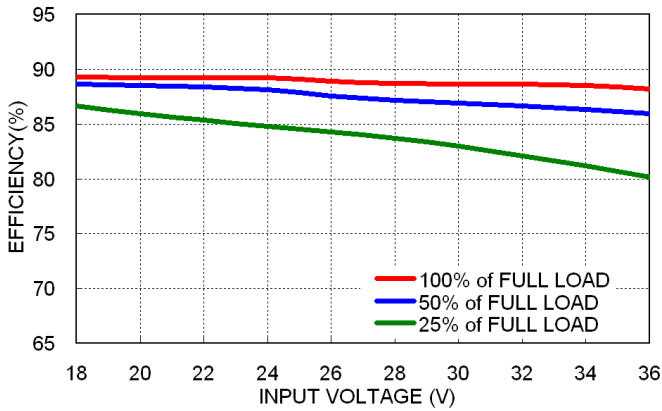

Efficiency versus Input Voltage Full Load

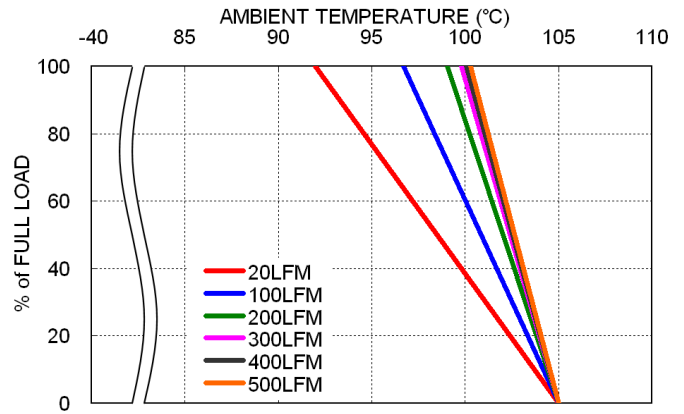

Derating Output Current versus Ambient Temperature and Airflow Vin(nom)

Characteristic Curves (Continued)

All test conditions are at 25°C. The figures are for PXC-M06-24WS24

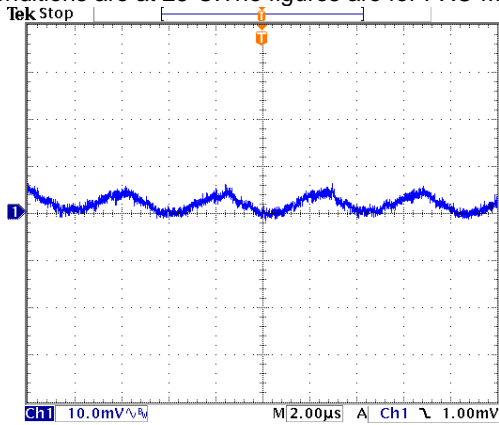

Typical Output Ripple and Noise.
Vin(nom); Full Load

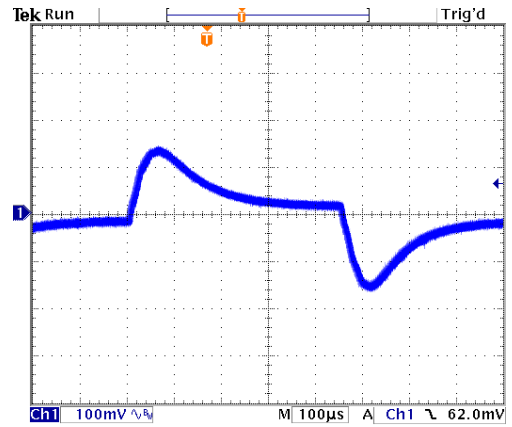

Transient Response to Dynamic Load Change from
100% to 75% to 100% of Full Load; Vin(nom)

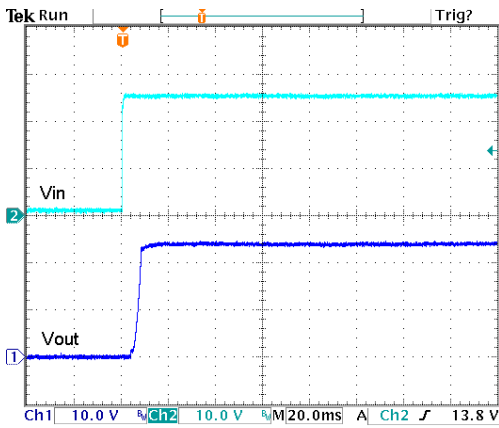

Typical Input Start-Up and Output Rise Characteristic
Vin(nom); Full Load

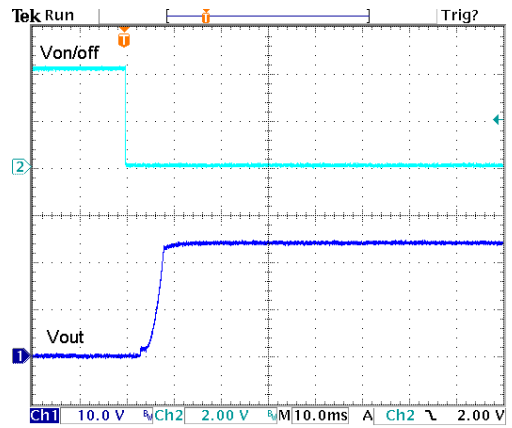

Using ON/OFF Voltage Start-Up and Output Rise Characteristic
Vin(nom); Full Load

Characteristic Curves

All test conditions are at 25°C. The figures are for PXC-M06-48WS3P3

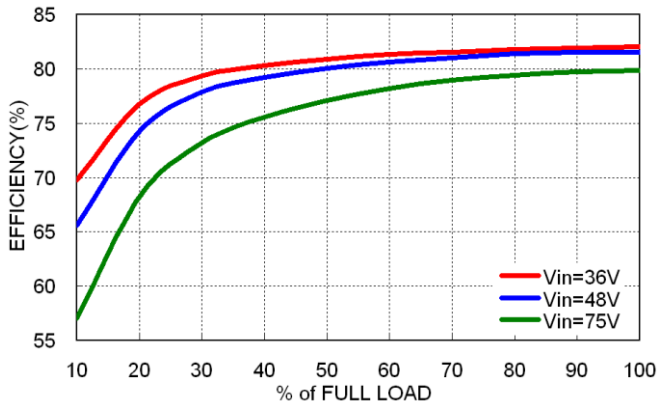

Efficiency versus Output Current

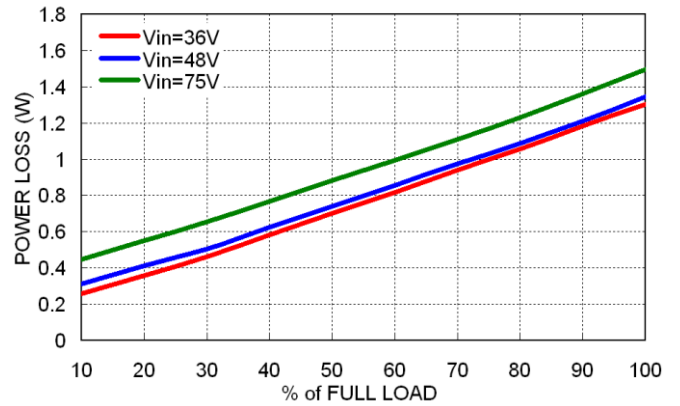

Power Dissipation versus Output Current

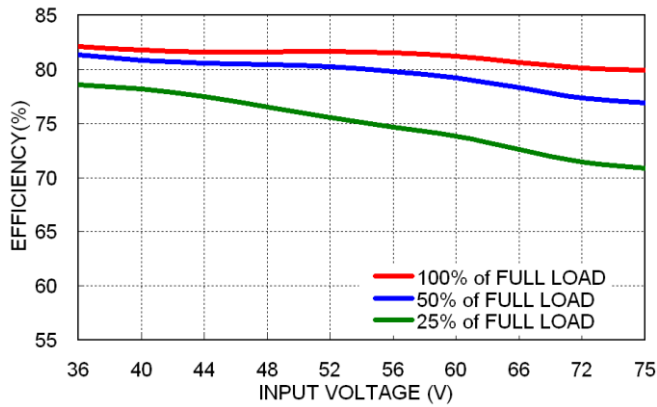

Efficiency versus Input Voltage Full Load

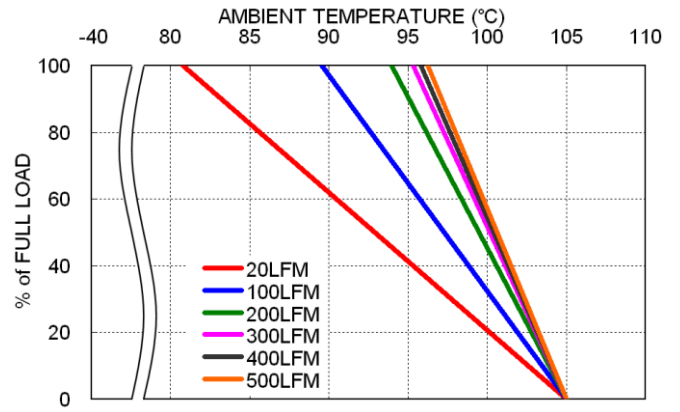

Derating Output Current versus Ambient Temperature and Airflow Vin(nom)

Characteristic Curves (Continued)

All test conditions are at 25°C. The figures are for PXC-M06-48WS3P3

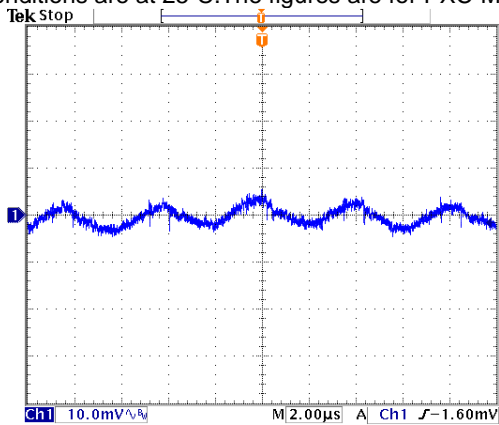

Typical Output Ripple and Noise.
Vin(nom); Full Load

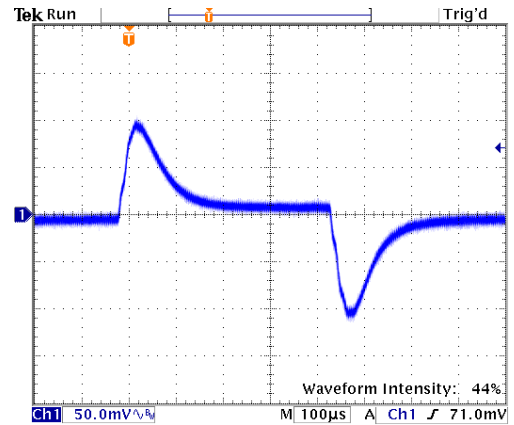

Transient Response to Dynamic Load Change from
100% to 75% to 100% of Full Load; Vin(nom)

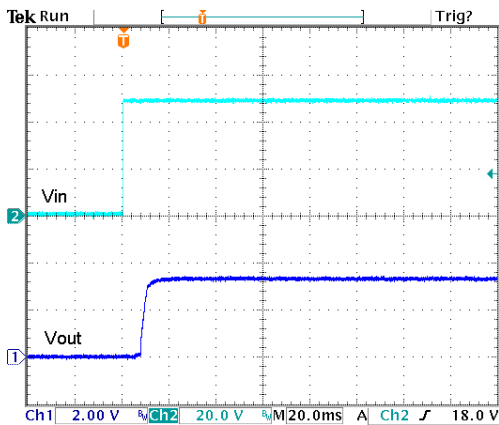

Typical Input Start-Up and Output Rise Characteristic
Vin(nom); Full Load

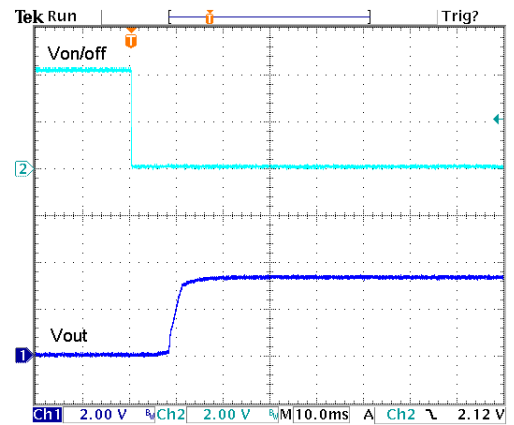

Using ON/OFF Voltage Start-Up and Output Rise Characteristic
Vin(nom); Full Load

Characteristic Curves (Continued)

All test conditions are at 25°C. The figures are for PXC-M06-48WS05

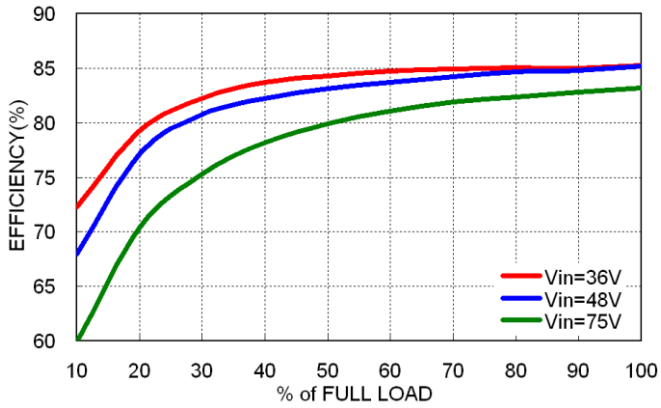

Efficiency versus Output Current

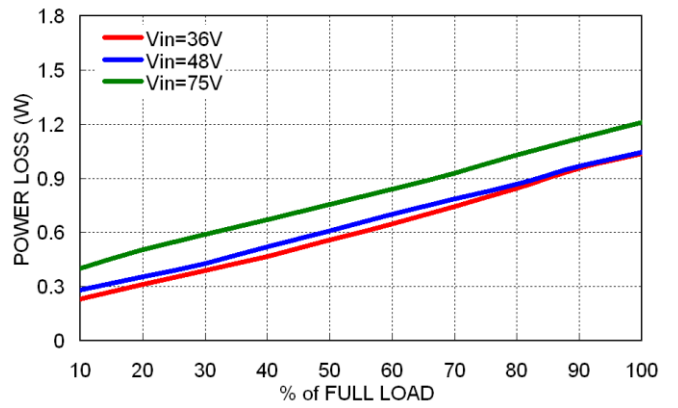

Power Dissipation versus Output Current

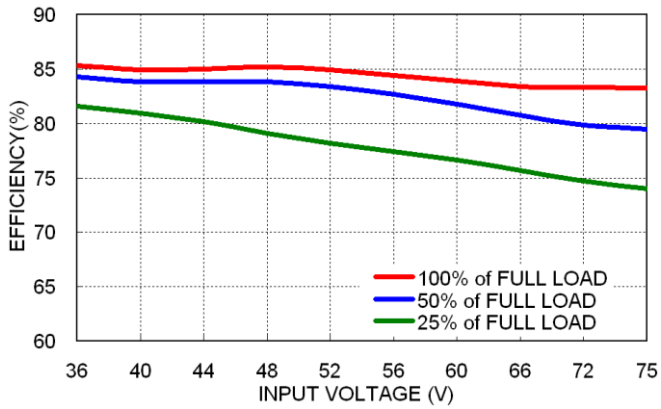

Efficiency versus Input Voltage Full Load

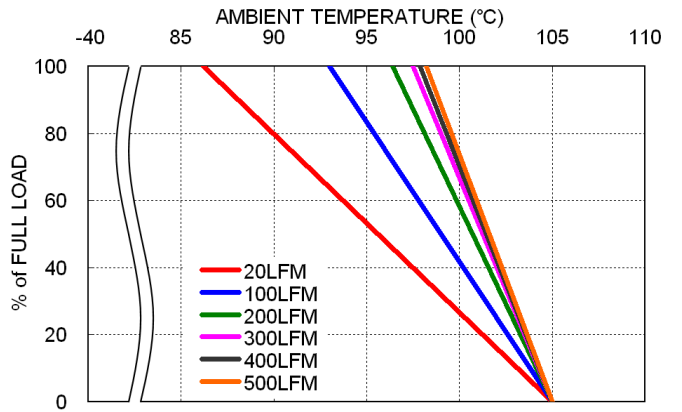

Derating Output Current versus Ambient Temperature and Airflow Vin(nom)

Characteristic Curves (Continued)

All test conditions are at 25°C. The figures are for PXC-M06-48WS05

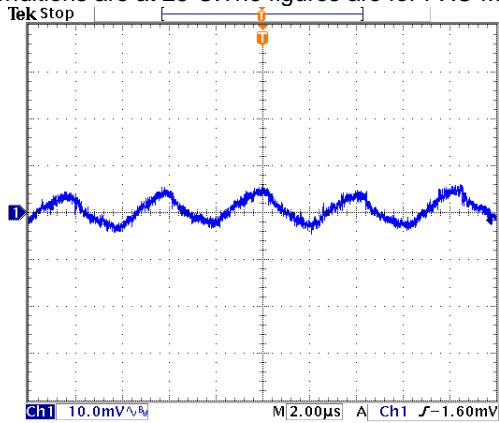

Typical Output Ripple and Noise.
Vin(nom); Full Load

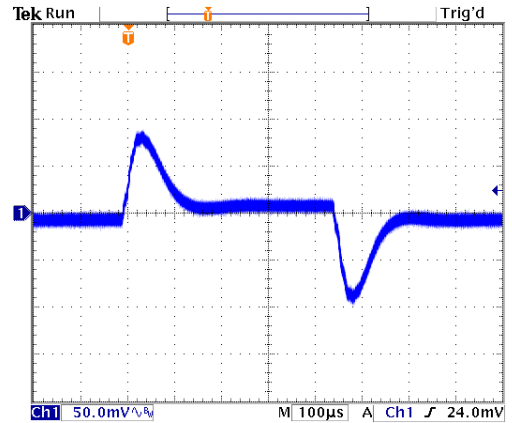

Transient Response to Dynamic Load Change from
100% to 75% to 100% of Full Load; Vin(nom)

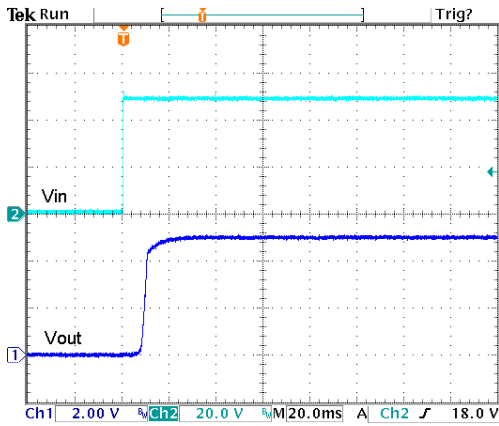

Typical Input Start-Up and Output Rise Characteristic
Vin(nom); Full Load

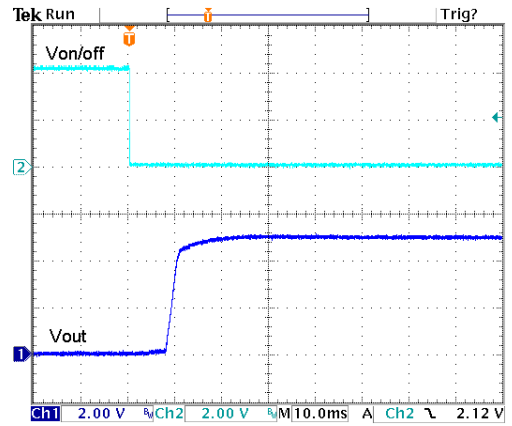

Using ON/OFF Voltage Start-Up and Output Rise Characteristic
Vin(nom); Full Load

Characteristic Curves (Continued)

All test conditions are at 25°C. The figures are for PXC-M06-48WS12

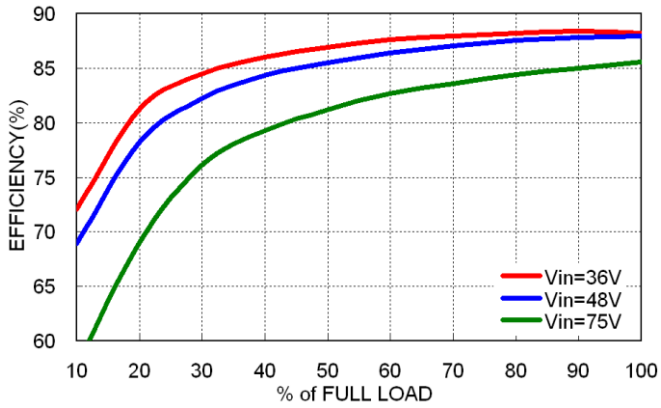

Efficiency versus Output Current

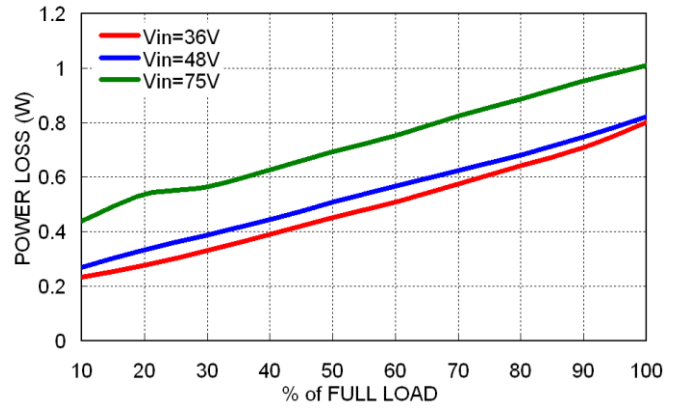

Power Dissipation versus Output Current

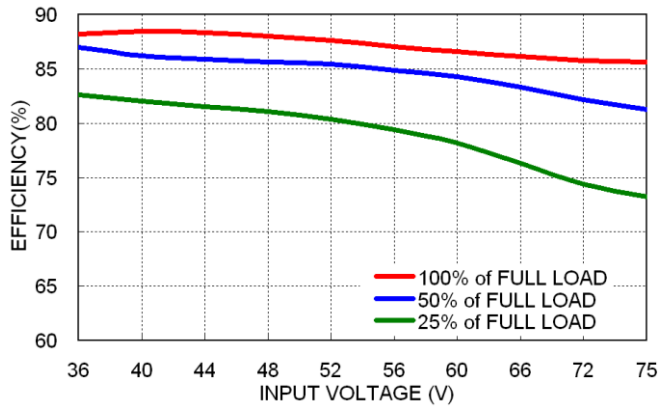

Efficiency versus Input Voltage Full Load

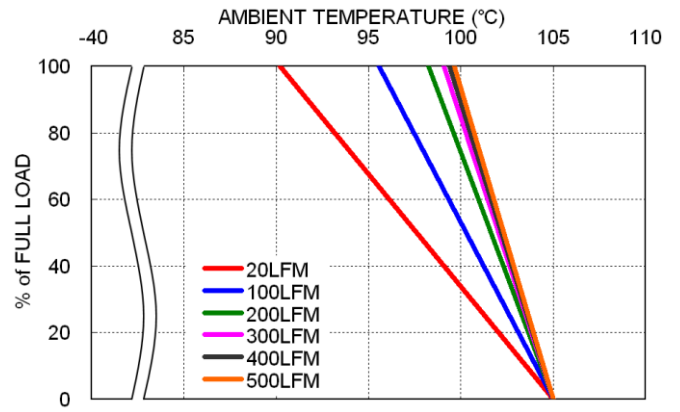

Derating Output Current versus Ambient Temperature and Airflow Vin(nom)

Characteristic Curves (Continued)

All test conditions are at 25°C. The figures are for PXC-M06-48WS12

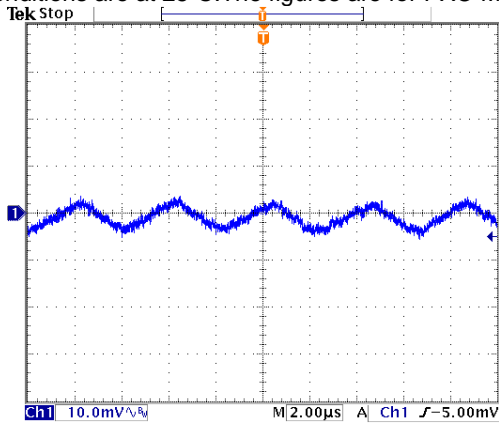

Typical Output Ripple and Noise.
Vin(nom); Full Load

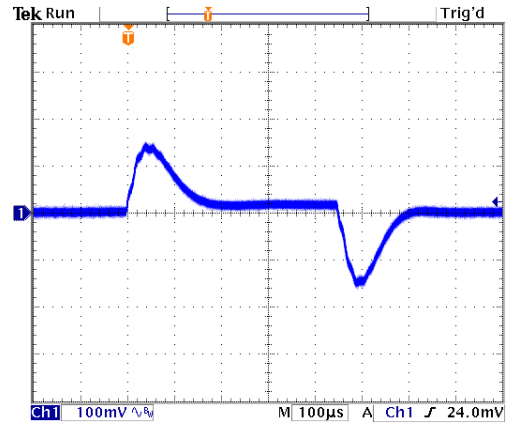

Transient Response to Dynamic Load Change from
100% to 75% to 100% of Full Load; Vin(nom)

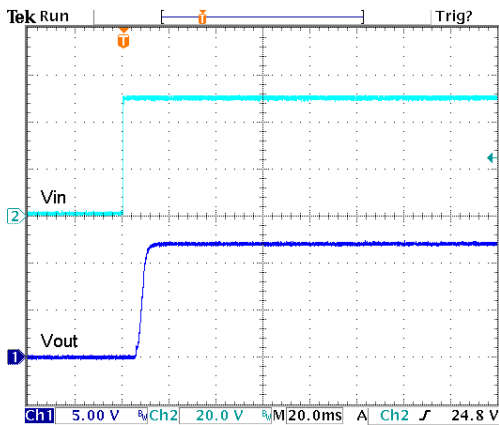

Typical Input Start-Up and Output Rise Characteristic
Vin(nom); Full Load

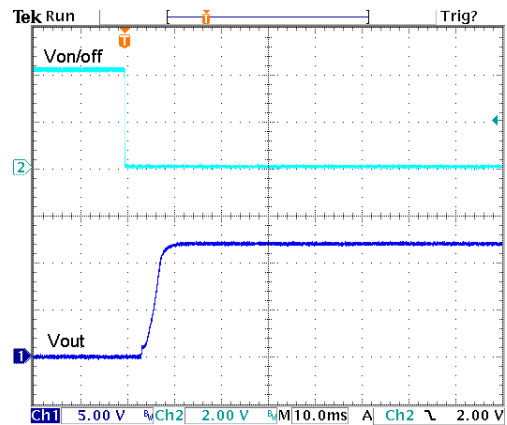

Using ON/OFF Voltage Start-Up and Output Rise Characteristic
Vin(nom); Full Load

Characteristic Curves (Continued)

All test conditions are at 25°C. The figures are for PXC-M06-48WS15

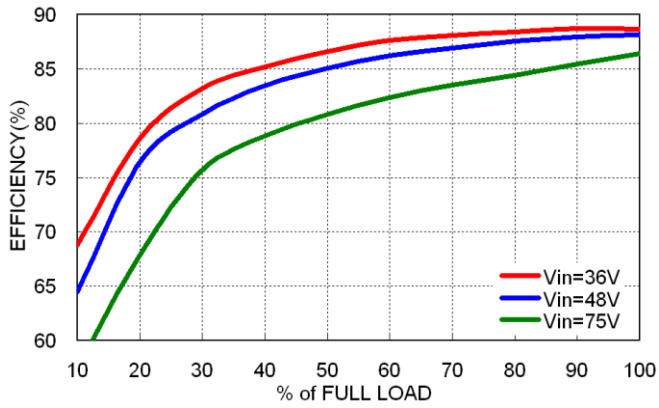

Efficiency versus Output Current

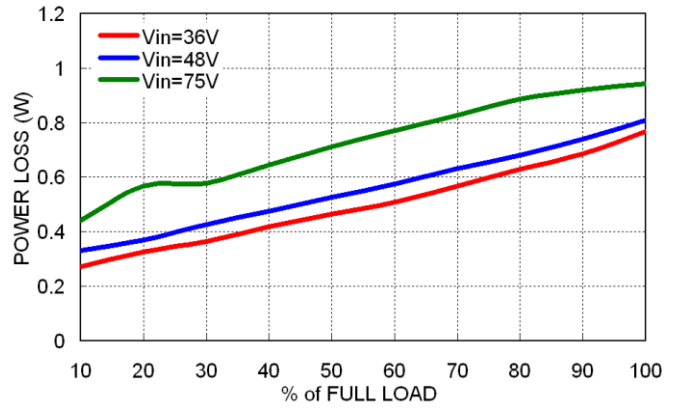

Power Dissipation versus Output Current

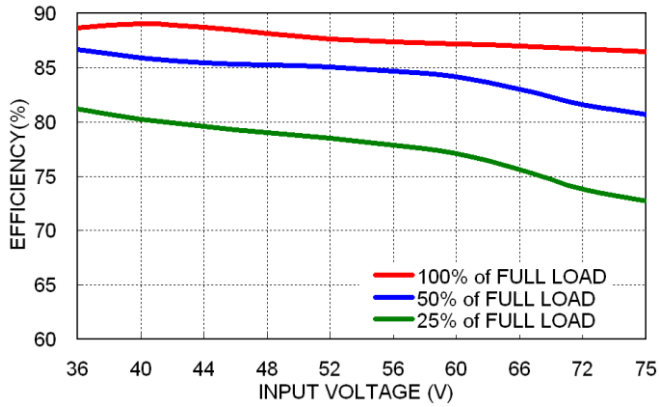

Efficiency versus Input Voltage Full Load

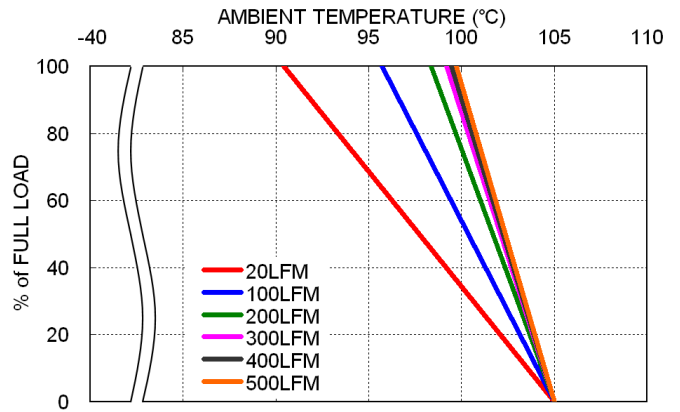

Derating Output Current versus Ambient Temperature and Airflow Vin(nom)

Characteristic Curves (Continued)

All test conditions are at 25°C. The figures are for PXC-M06-48WS15

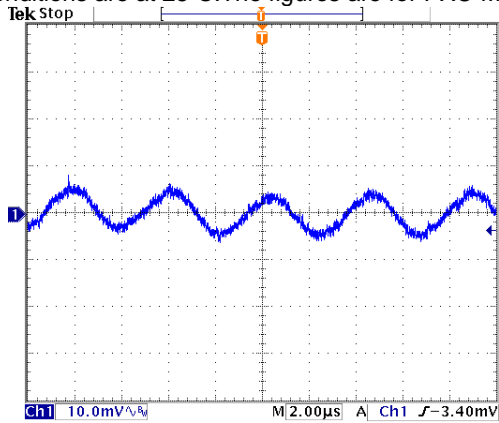

Typical Output Ripple and Noise.
Vin(nom); Full Load

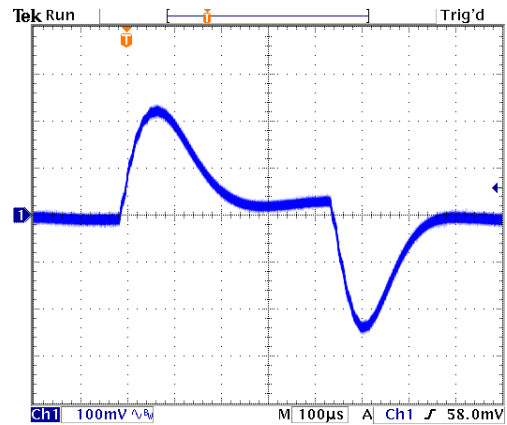

Transient Response to Dynamic Load Change from
100% to 75% to 100% of Full Load; Vin(nom)

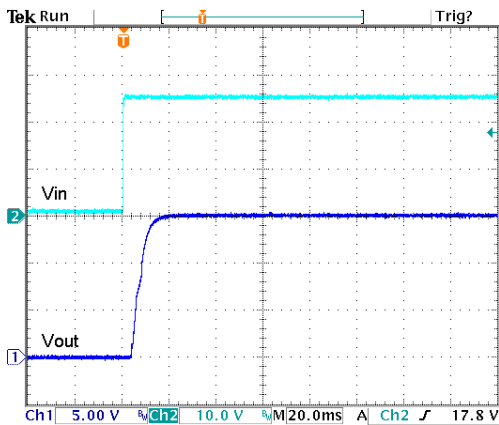

Typical Input Start-Up and Output Rise Characteristic
Vin(nom); Full Load

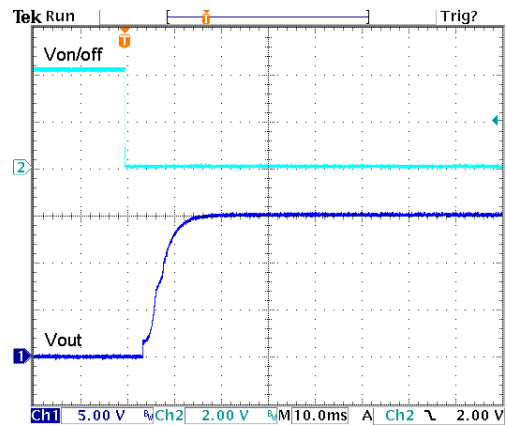

Using ON/OFF Voltage Start-Up and Output Rise Characteristic
Vin(nom); Full Load

Characteristic Curves (Continued)

All test conditions are at 25°C. The figures are for PXC-M06-48WS24

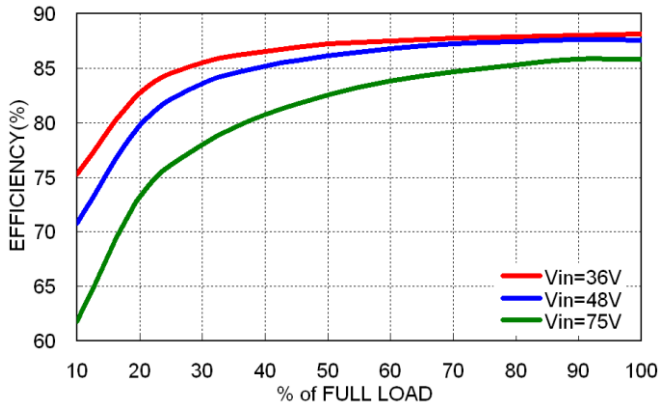

Efficiency versus Output Current

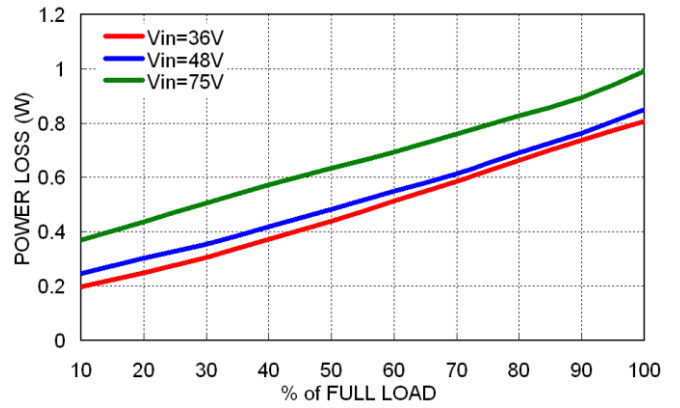

Power Dissipation versus Output Current

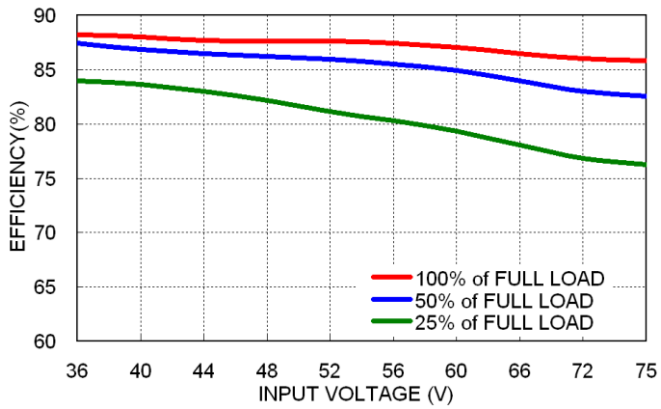

Efficiency versus Input Voltage Full Load

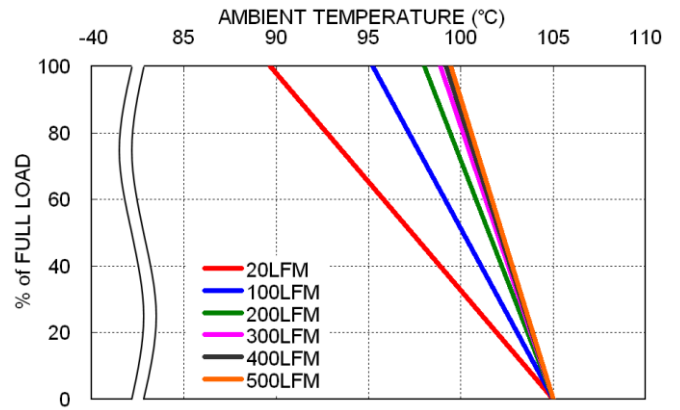

Derating Output Current versus Ambient Temperature and Airflow Vin(nom)

Characteristic Curves (Continued)

All test conditions are at 25°C. The figures are for PXC-M06-48WS24

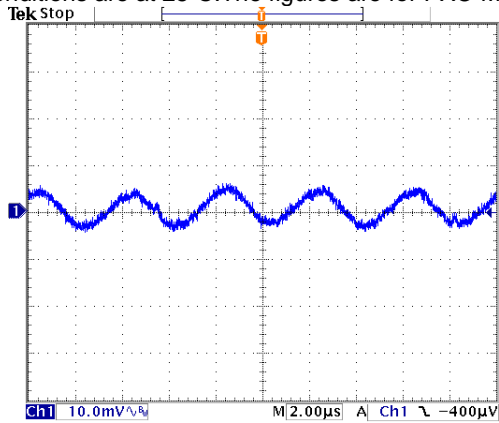

Typical Output Ripple and Noise.
Vin(nom); Full Load

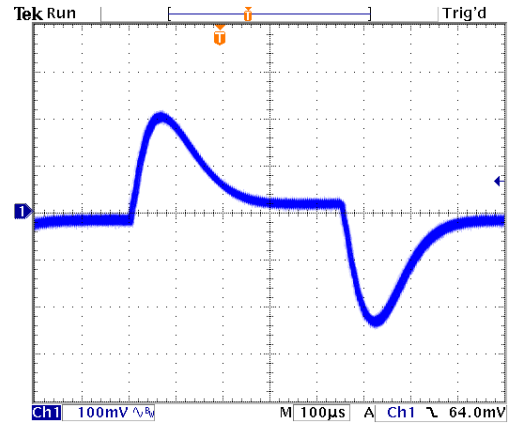

Transient Response to Dynamic Load Change from
100% to 75% to 100% of Full Load; Vin(nom)

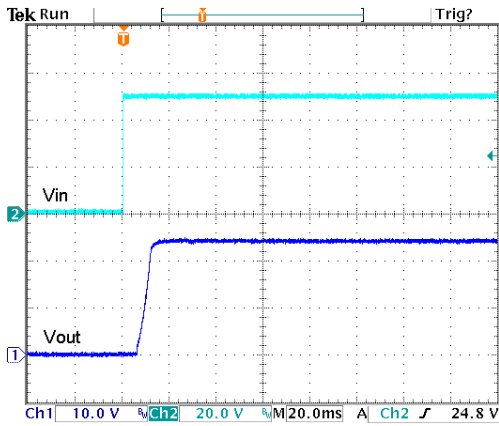

Typical Input Start-Up and Output Rise Characteristic
Vin(nom); Full Load

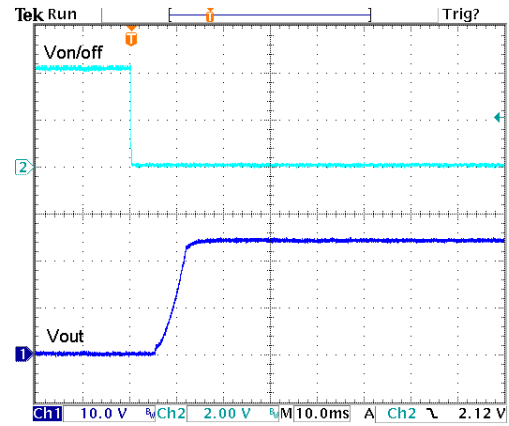

Using ON/OFF Voltage Start-Up and Output Rise Characteristic
Vin(nom); Full Load

Output Voltage Adjustment

Output voltage adjustment is an optional function for PXC-M06-xxWSxx-xT.

It allows the user to increase or decrease the output voltage of the module. This is accomplished by connecting an external resistor between the TRIM pin and either the +Vout or -Vout pins. With an external resistor between the TRIM and -OUTPUT pin, the output voltage increases. With an external resistor between the TRIM and +OUTPUT pin, the output voltage decreases. The external TRIM resistor needs to be at least 1/16W of rated power.

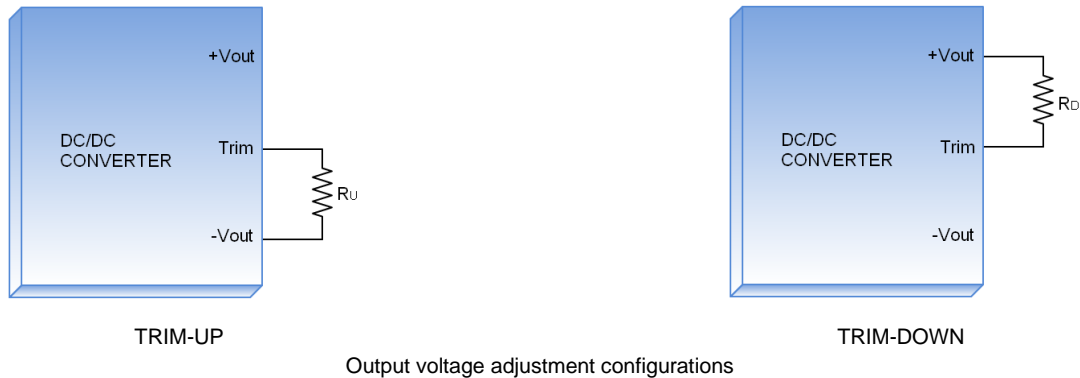

TRIM TABLE

xxWS3P3-xT		TRIM-UP									
Trim-Up (%)		1	2	3	4	5	6	7	8	9	10
Vout (V)		3.333	3.366	3.399	3.432	3.465	3.498	3.531	3.564	3.597	3.630
RU (kΩ)		385.837	191.894	127.246	94.922	75.527	62.598	53.362	46.436	41.049	36.739

TRIM-DOWN											
Trim-Down (%)		1	2	3	4	5	6	7	8	9	10
Vout (V)		3.267	3.234	3.201	3.168	3.135	3.102	3.069	3.036	3.003	2.970
RD (kΩ)		114.963	53.906	33.554	23.378	17.273	13.202	10.295	8.114	6.418	5.061

xxWS05-xT		TRIM-UP									
Trim-Up (%)		1	2	3	4	5	6	7	8	9	10
Vout (V)		5.048	5.098	5.148	5.198	5.248	5.298	5.348	5.398	5.448	5.498
RU (kΩ)		252.301	125.126	82.734	61.538	48.820	40.342	34.286	29.744	26.211	23.385

TRIM-DOWN											
Trim-Down (%)		1	2	3	4	5	6	7	8	9	10
Vout (V)		4.948	4.898	4.848	4.798	4.748	4.698	4.648	4.598	4.548	4.498
RD (kΩ)		248.499	120.674	78.066	56.762	43.980	35.458	29.371	24.806	21.255	18.415

xxWS12-xT		TRIM-UP									
Trim-Up (%)		1	2	3	4	5	6	7	8	9	10
Vout (V)		12.121	12.241	12.361	12.481	12.601	12.721	12.841	12.961	13.081	13.201
RU (kΩ)		202.645	98.772	64.148	46.836	36.449	29.524	24.578	20.868	17.983	15.674

TRIM-DOWN											
Trim-Down (%)		1	2	3	4	5	6	7	8	9	10
Vout (V)		11.881	11.761	11.641	11.521	11.401	11.281	11.161	11.041	10.921	10.801
RD (kΩ)		777.155	381.028	248.985	182.964	143.351	116.943	98.079	83.932	72.928	64.126

Output Voltage Adjustment (Continued)

TRIM TABLE (Continued)

xxWS15-xT		TRIM-UP									
Trim-Up (%)		2	4	6	8	10	12	14	16	18	20
Vout (V)		15.305	15.605	15.905	16.205	16.505	16.806	17.106	17.406	17.706	18.006
RU (kΩ)		77.962	36.431	22.587	15.665	11.512	8.744	6.766	5.283	4.129	3.206

TRIM-DOWN											
Trim-Down (%)		1	2	3	4	5	6	7	8	9	10
Vout (V)		14.855	14.705	14.555	14.405	14.255	14.105	13.955	13.805	13.654	13.504
RD (kΩ)		818.776	401.838	262.859	193.369	151.675	123.879	104.025	89.135	77.553	68.288

xxWS24-xT		TRIM-UP									
Trim-Up (%)		2	4	6	8	10	12	14	16	18	20
Vout (V)		24.484	24.964	25.444	25.924	26.404	26.884	27.364	27.844	28.324	28.804
RU (kΩ)		277.598	132.299	83.866	59.650	45.120	35.433	28.514	23.325	19.289	16.060

TRIM-DOWN											
Trim-Down (%)		1	2	3	4	5	6	7	8	9	10
Vout (V)		23.764	23.524	23.283	23.043	22.803	22.563	22.323	22.083	21.843	21.603
RD (kΩ)		4949.803	2440.402	1603.934	1185.701	934.761	767.467	647.972	558.350	488.645	432.880

Input Source Impedance

The power module should be connected to a low impedance input source. Highly inductive source impedance can affect the stability of the power module. Install choke (LSIM) to simulate the impedance of power source. External input capacitors CFILTER serve primarily as energy-storage elements, minimizing line voltage variations caused by transient IR drops in conductors from backplane to the DC/DC. The capacitor must as close as possible to the input terminals of the power module for lower impedance. The input reflected-ripple current measurement configuration is shown below:

Input reflected-ripple current measurement setup

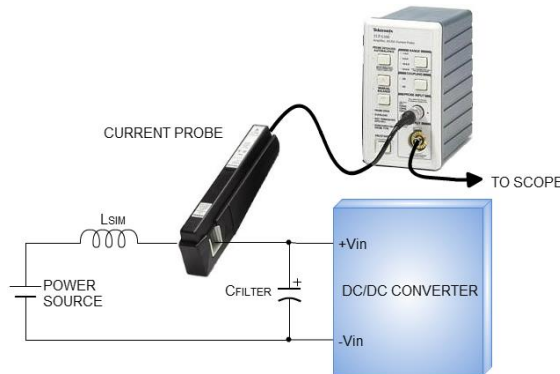

PXC-M06-24WSxx

Component	Value	Voltage	Reference
LSIM	12μH	----	Inductor
CFILTER	47μF	100V	Nippon chemi-con KY-series

PXC-M06-48WSxx

Component	Value	Voltage	Reference
LSIM	12μH	----	Inductor
CFILTER	47μF	100V	Nippon chemi-con KY-series

Output Over Current Protection

When excessive output currents occur in the system, circuit protection is required on all power supplies. Normally, overload current is maintained at approximately 150 percent of rated current for PXC-M06W SERIES.

Hiccup-mode is a method of operation in a power supply whose purpose is to protect the power supply from being damaged during an over-current fault condition. It also enables the power supply to restart when the fault is removed. There are other ways of protecting the power supply when it is over-loaded, such as the maximum current limiting or current fold-back methods.

One of the problems resulting from over current is that excessive heat may be generated in power devices; especially MOSFET and Schottky diodes and the temperature of those devices may exceed their specified limits. A protection mechanism has to be used to prevent those power devices from being damaged.

The operation of hiccup is as follows. When the current sense circuit sees an over-current event, the controller shuts off the power supply for a given time and then tries to start up the power supply again. If the over-load condition has been removed, the power supply will start up and operate normally; otherwise, the controller will see another over-current event and shut off the power supply again, repeating the previous cycle. Hiccup operation has none of the drawbacks of the other two protection methods, although its circuit is more complicated because it requires a timing circuit. The excess heat due to overload lasts for only a short duration in the hiccup cycle, hence the junction temperature of the power devices is much lower.

The hiccup operation can be done in various ways. For example, one can start hiccup operation any time an over-current event is detected; or prohibit hiccup during a designated start-up interval (usually a few milliseconds). The reason for the latter operation is that during start-up, the power supply needs to provide extra current to charge up the output capacitor. Thus the current demand during start-up is usually larger than during normal operation and it is easier for an over-current event to occur. If the power supply starts to hiccup once there is an over-current, it might never start up successfully. Hiccup mode protection will give the best protection for a power supply against over current situations, since it will limit the average current to the load at a low level, so reducing power dissipation and case temperature in the power devices.

Output Short Circuitry Protection

Continuous and auto-recovery mode.

During short circuit, converter still shut down. The average current during this condition will be very low and the device can be safety in this condition.

Output Over Voltage Protection

The output over-voltage protection consists of circuitry that internally clamps the output voltage. If a more accurate output over-voltage protection scheme is required then this should be implemented externally via use of the remote on/off pin.

Thermal Considerations

The power module operates in a variety of thermal environments; however, sufficient cooling should be provided to help ensure reliable operation of the unit. Heat is removed by conduction, convection, and radiation to the surrounding environment. Proper cooling can be verified by measuring the point as shown in the figure below. The temperature at this location should not exceed 105°C. When operating, adequate cooling must be provided to maintain the test point temperature at or below 105°C. Although the maximum point temperature of the power modules is 105°C, limiting this temperature to a lower value enhances the reliability.

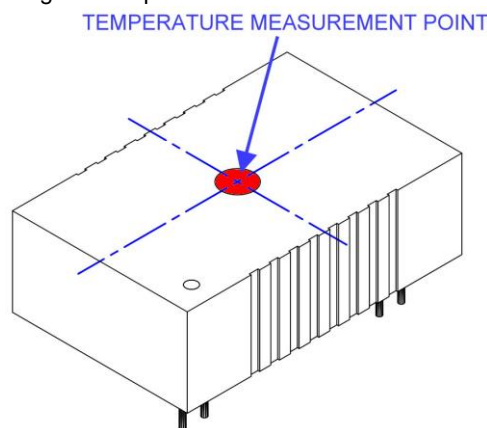

Remote On/off Control

Only for B-type pin connection option with suffix -P. Ex.: PXC-M06-24WS05-P

The module is ON during logic Low and turns OFF during logic High. The Ctrl pin is an open collector/drain logic input signal that is referenced to (-)Vin. If not using the remote on/off feature, the Ctrl and (-)Vin pins should be connected together (shorted) or apply 0-1.2V between these two pins for the module to be ON.

Remote ON/OFF Implementation

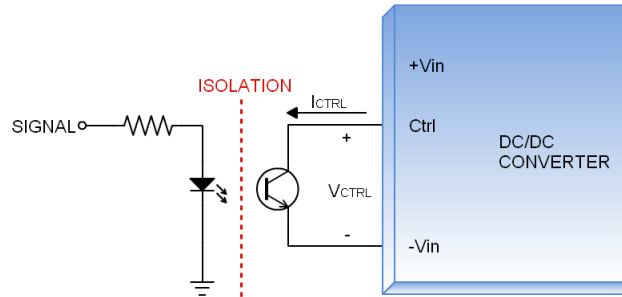

Isolated-Control Remote ON/OFF

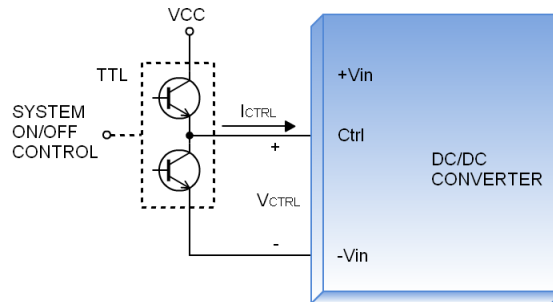

Level Control Using TTL Output

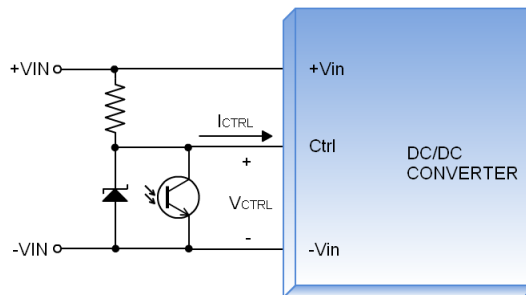

Level Control Using Line Voltage

EMS Considerations

The PXC-M06W series can meet Fast Transient EN61000-4-4 and Surge EN61000-4-5 performance criteria A with external components connected to the input terminals of the module. Please see the following schematic:

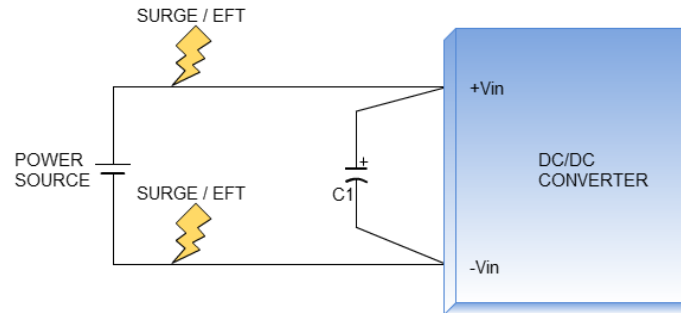

SURGE / Fast Transient

PXC-M06-24WSxx

Component	Value	Voltage	Reference
C1	470 μ F	50V	Nippon chemi-con KY-series

PXC-M06-48WSxx

Component	Value	Voltage	Reference
C1	330 μ F	100V	Nippon chemi-con KY-series

Mechanical Data

PXC-M06-xxWSxx A Type

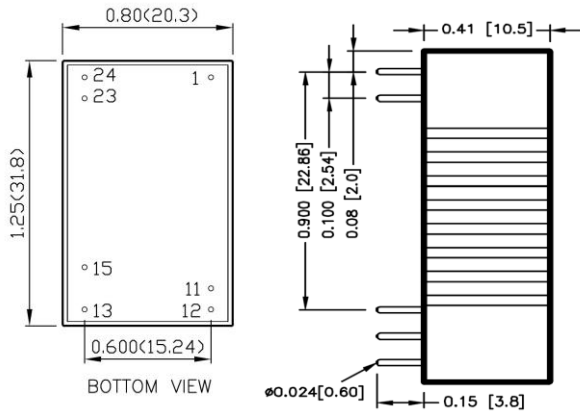

PIN CONNECTION

PIN	FUNCTION
1	+ Vin
11	No pin
12	-Vout
13	+Vout
15	No pin
23	- Vin
24	- Vin

1. All dimensions in Inch (mm)
2. Tolerance: X.XX±0.02 (X.X±0.5)
X.XXX±0.01 (X.XX±0.25)
3. Pin pitch tolerance ±0.01 (0.25)
4. Pin dimension tolerance ±0.004 (0.1)

PXC-M06-xxWSxx B Type

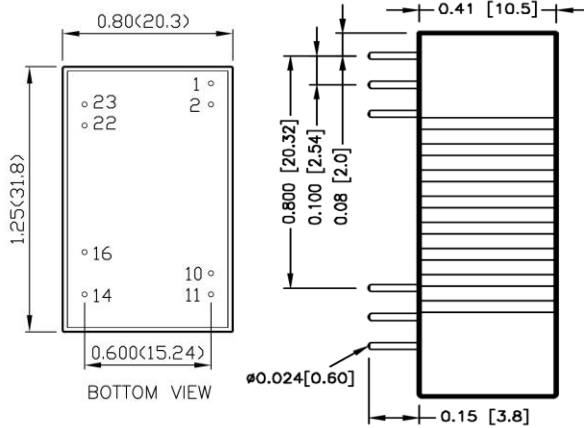

PIN CONNECTION

PIN	FUNCTION
1	Ctrl (Option) / No pin*
2	- Vin
10	Trim (Option) / No pin*
11	No pin / NC**
14	+Vout
16	-Vout
22	+Vin
23	+Vin

* If no Ctrl or Trim option, there is no pin on the corresponding pin number.

** Pin 11 is "No pin" for
PXC-M06-xxSxxWB-I
PXC-M06-xxSxxWB-PT
Pin 11 is "NC" for
PXC-M06-xxSxxWB
PXC-M06-xxSxxWB-P

1. All dimensions in Inch (mm)
2. Tolerance: X.XX±0.02 (X.X±0.5)
X.XXX±0.01 (X.XX±0.25)
3. Pin pitch tolerance ±0.01 (0.25)
4. Pin dimension tolerance ±0.004 (0.1)

Recommended Pad Layout

PXC-M06-xxWSxx A Type

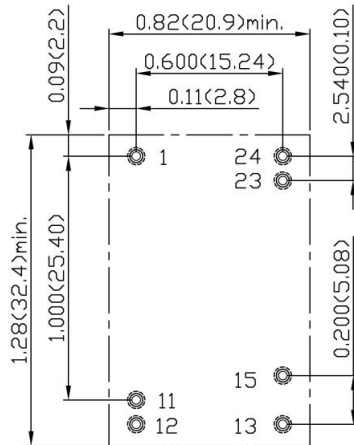

PXC-M06-xxWSxx B Type

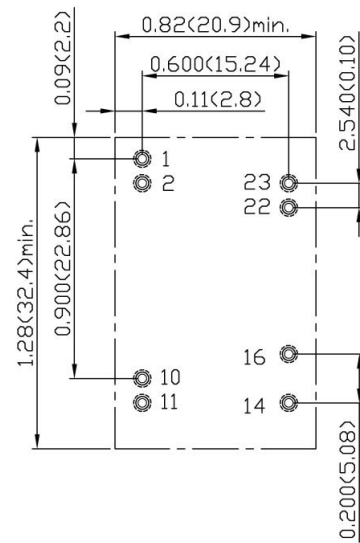

1. All dimensions in Inch (mm)
Tolerance: X.XX±0.02 (X.X±0.5)
X.XXX±0.01 (X.XX±0.25)
2. Pin pitch tolerance ±0.01 (0.25)
3. Pin dimension tolerance ±0.004 (0.1)

Soldering Considerations

Lead free wave solder profile

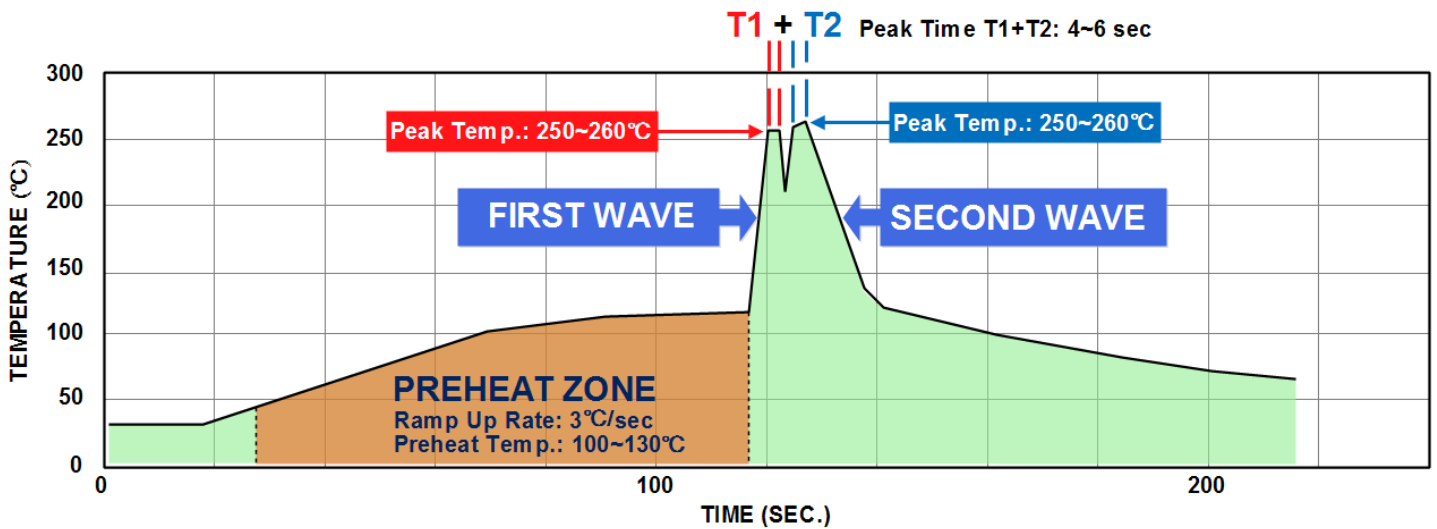

Reference Solder : Sn-Ag-Cu ; Sn-Cu

Hand Soldering (Reference) :

Soldering iron : Power 150W

Soldering Time : 3-6 sec

Temp : 410-430°C

Packaging Information

Tube

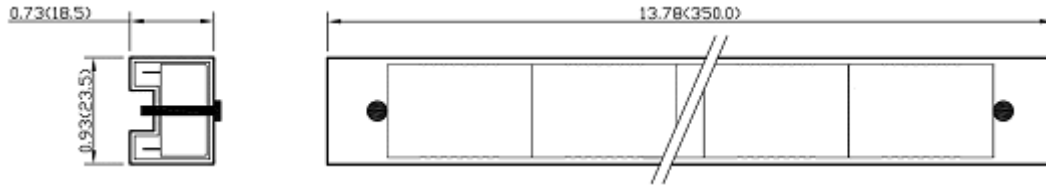

10pcs converters in a Tube
All dimensions in inches (mm)

Part Number Structure

PXC-M06 Series Name	- 48W Input Voltage (VDC) 24: 9~36 48: 18~75	S Output Quantity S: Single	05 Output Voltage (VDC) 3P3: 05: 12: 15: 24:	A Pin Connection Option A: A type B: B type	- P Remote On/Off Option □: No On/Off control P: Remote On/Off (Only for B type Pin connection)	T Trim Option □: No Trim T: Trim (Only for B type Pin connection)
			D: Dual 05: ±5 12: ±12 15: ±15			

Model Number	Input Range VDC	Output Voltage VDC	Output Current @ Full Load mA	Input Current @ No Load mA	Efficiency %	Maximum Capacitor Load µF
PXC-M06-24WS3P3A/□	9 ~ 36	3.3	1800	6	83	2100
PXC-M06-24WS05A/□		5	1200	6	86	1500
PXC-M06-24WS12A/□		12	500	6	89	260
PXC-M06-24WS15A/□		15	400	6	89	210
PXC-M06-24WS24A/□		24	250	6	88.5	75
PXC-M06-48WS3P3A/□	18 ~ 75	3.3	1800	4	82.5	2100
PXC-M06-48WS05A/□		5	1200	4	86.5	1500
PXC-M06-48WS12A/□		12	500	4	88	260
PXC-M06-48WS15A/□		15	400	4	88.5	210
PXC-M06-48WS24A/□		24	250	4	88	75

Safety and Installation Instructions

Fusing Consideration

Caution: This power module is not internally fused. An input line fuse must always be used.

This encapsulated power module can be used in a wide variety of applications, ranging from simple stand-alone operation to an integrated part of sophisticated power architecture. For maximum flexibility, internal fusing is not included; however, to achieve maximum safety and system protection, always use an input line fuse. Please suggested values below:

Model	Fuse Rating (A)	Fuse Type
PXC-M06-24WSxx	1.25	Slow-Blow
PXC-M06-48WSxx	0.63	Slow-Blow

Based on the information provided in this data sheet on inrush energy and maximum dc input current at low Vin.

MTBF and Reliability

The MTBF has been calculated using:

MIL-HDBK 217F NOTICE2 FULL LOAD, Operating Temperature at 25°C. The resulting figure for MTBF is 4.718×10⁶ hours.