

Attracting Tomorrow



μ POLTM Technology FS1406, User Guide

$P_{Vin}=12V, V_o=0.8V@6A$

User Guide for FS1406 Evaluation Board

-This board facilitates the evaluation of the FS1406 μ POL[®]. The Output voltage is 0.8V, up to 6A from input voltages 12V.

-PVin: J1, input for 12V (+)

-Gnd: J2, Input for 12V (-)

-Vout: J8, Output (+)

-Vout: J7, Output (-)

User Guide for FS1406 Evaluation Board

-Board Features:

- $V_{in} = +12V$
- $V_o = 0.8V$
- $I_o = 0A - 6A$
- $F_s = 1 \text{ MHz}$
- $C_o = 3 \times 47\mu F \text{ MLCC}$
- $C_{in} = 2 \times 22\mu F \text{ MLCC}$
- Output Voltage Ripple $< \pm 0.7\%$

Connection and Operating Instruction

- A well regulated +12V input supply should be connected to PVIN (**J1**) and GND (**J2**).
- A maximum of 6A load should be connected to VOUT(**J8**) and GND (**J7**). The inputs and output connections of the board are listed in Table I.
- FS1406 is configured for only one input supply and internal LDO generates Internal Supply (Vcc) from PVin.
- There is a divider from PVin to Enable which ensures that proper sequencing is followed.

Table I, Connection

Connection	Signal Name
Pvin (J1)	Input Supply (12V)
GND (J2)	Ground connection for Input Supply
VOOUT(J8)	Vo (0.8V)
GND (J7)	Ground connection for output
Vcc (TP2)	Vcc / LDO output
GND (TP3)	Ground for Vcc
EN (TP11)	Enable
PG (TP12)	Power Good

Layout

The PCB is a 4-layer board (63mmx84mm) using FR4 material. All layers use 2 Oz. copper. The PCB thickness is 1.5mm. The FS1406 and other major power components are mounted on the top side of the board.

Connection Diagram

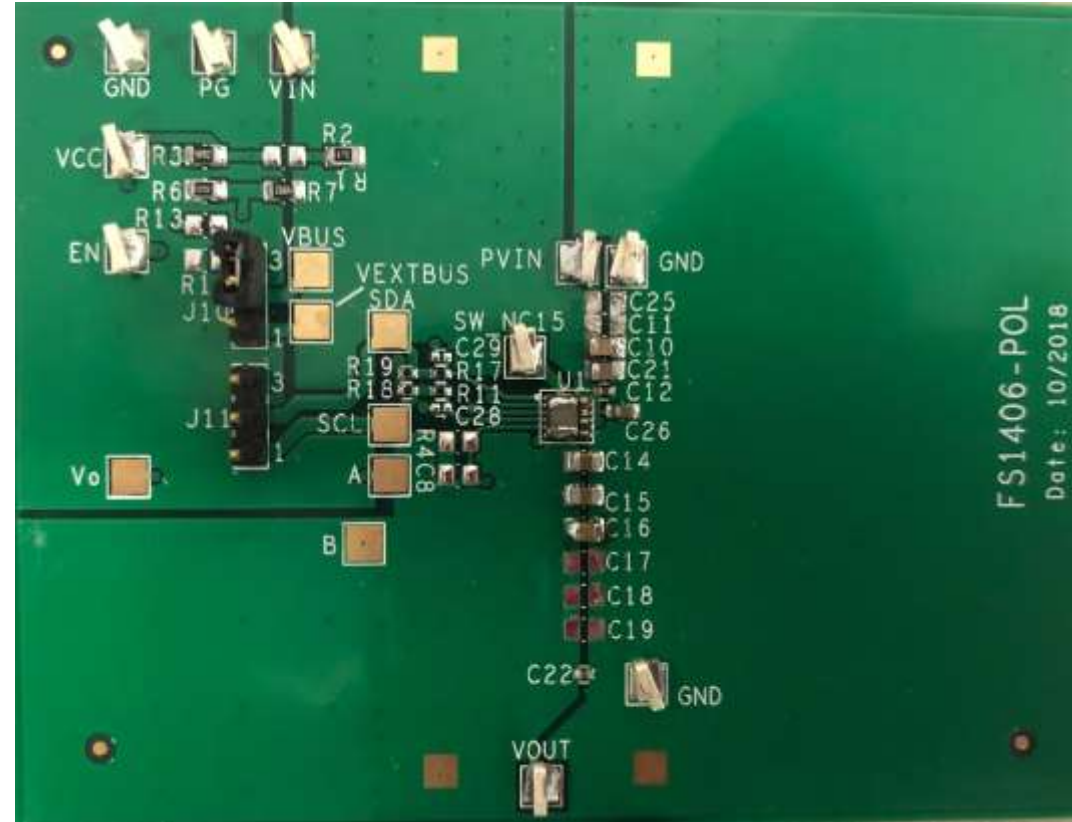

- The Board is configured so it can start up by applying only 12V supply.
- Enable is connected to PVin via a resistor divider, thus no need to apply Enable signal.

Schematic

Note: The I2C circuitry is optional.
The device operates as an analog DC-DC for the fixed voltage options.

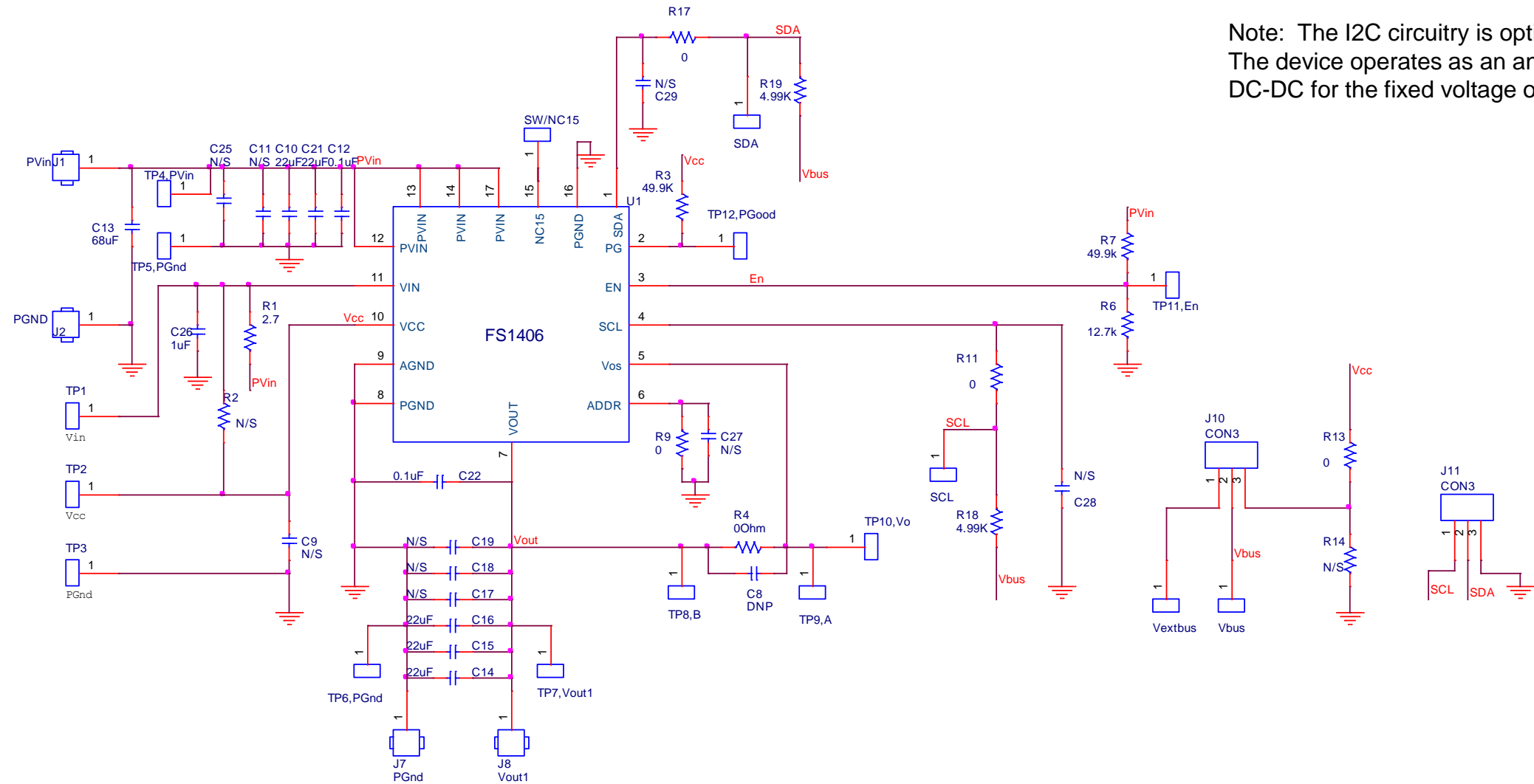

BOM

Part reference	Qty	Value	Description
FS1406 POL	1		Main IC
C13	1	68uF	25V
C14,C15,C16	3	47uF	0603, 6.3V, X5R
C12	1	0.1uF	0402, 16V, X7R
C10, C21	2	22uF	0805, 16V, X5R
R1	1	2.7 Ohm	5%, 1/8W, 0805 case size
R3,R7	2	49.9K	0805 case size
C26	1	1uF	0603,25V, X5R
R18,R19	2	4.99K	0402 case size
R6	1	12.7K	10%, 1/8W, 0805 case size
R4, R9, R11, R13, R17	5	0 Ohm	0402 case size
TP1-TP12, Sw/NC15, Vbus, Vextbus, SCL, SDA	17		Test Point
J1	1	RED	Banana Connector
J2,J7	2	Black	Banana Connector
J8	1	Green	Banana Connector
J10, J11	2		3 pin header

Typical Operating Waveforms

PVin=12.0V, Vo=0.8V, Io=0-6A, Room Temperature, no airflow

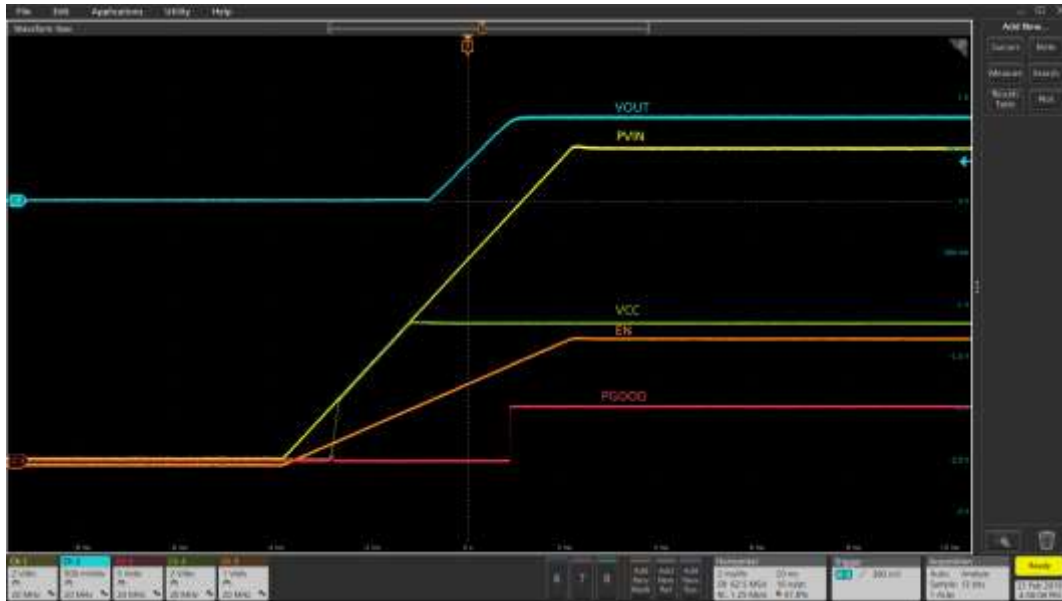

Start Up @ 0A

Ch 1: Vin Ch2: Vo Ch3: PGood Ch4: Vcc, Ch 5: En



Start Up @ 6A

Ch 1: Vin Ch2: Vo Ch3: PGood Ch4: Vcc, Ch 5: En

Typical Operating Waveforms

PVin=12.0V, Vo=0.8V, Io=0-6A, Room Temperature, no airflow

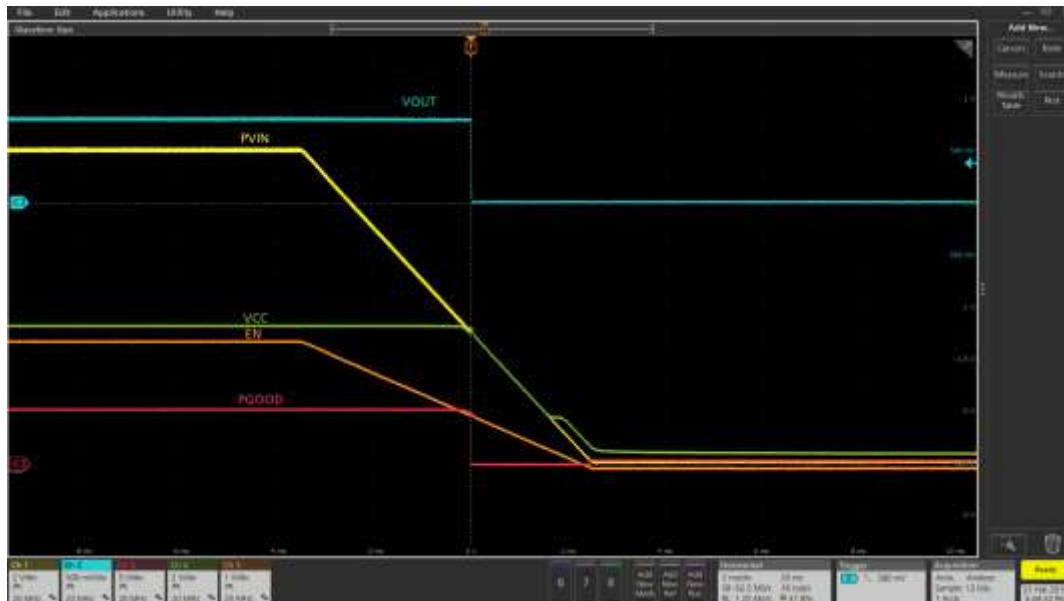

Shutdown at 6A with Enable

Ch 1: Vin Ch2: Vo Ch3: PGood Ch4: Vcc, Ch 5: En

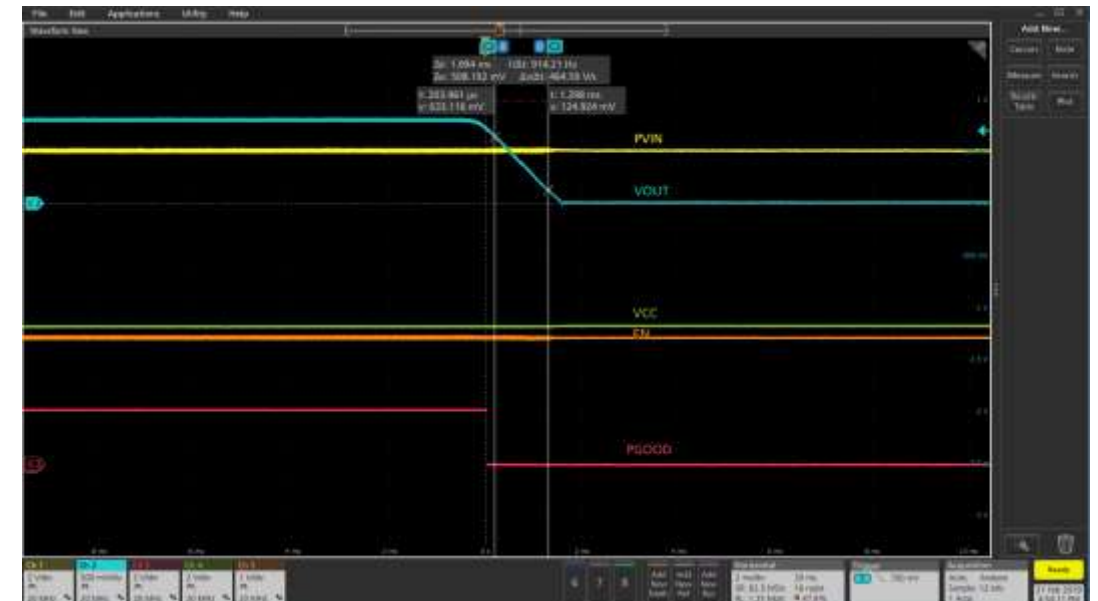

Soft turn off @ 6A

Ch 1: Vin Ch2: Vo Ch3: PGood Ch4: Vcc, Ch 5: En

Typical Operating Waveforms

PVin=12.0V, Vo=0.8V, Io=0-6A, Room Temperature, no airflow

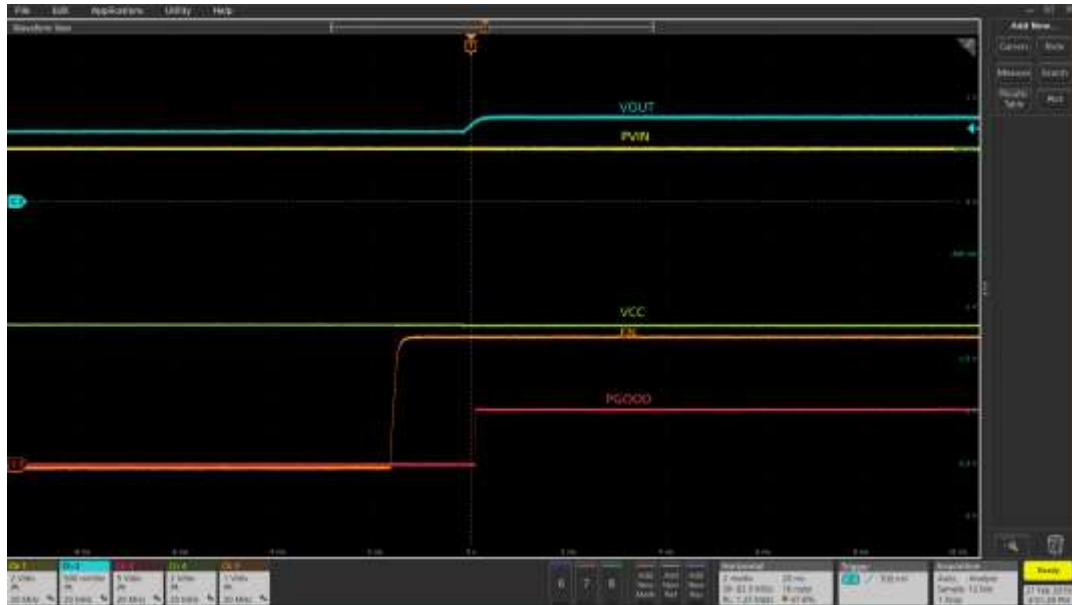

Startup into prebias

Ch 1: PVin Ch2: Vo Ch3: PGood Ch4: Vcc, Ch 5: En

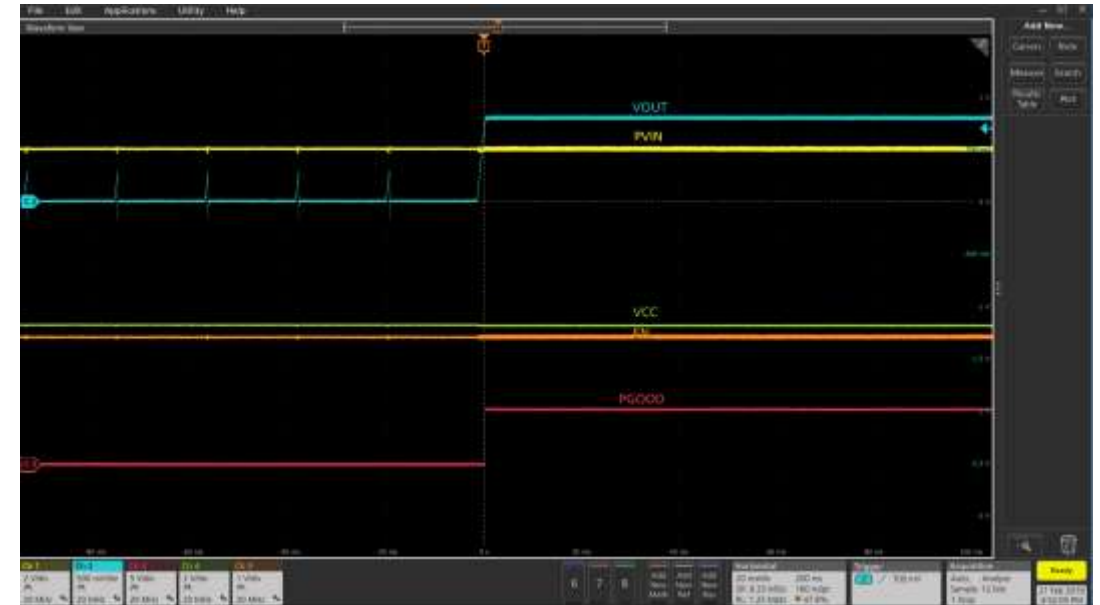

Over Current Protection and Auto Recover to 6A
Ch 1: PVin Ch2: Vo Ch3: PGood Ch4: Vcc, Ch 5: En

Typical Operating Waveforms

PVin=12.0V, Vo=0.8V, Io=0-6A, Room Temperature, no airflow

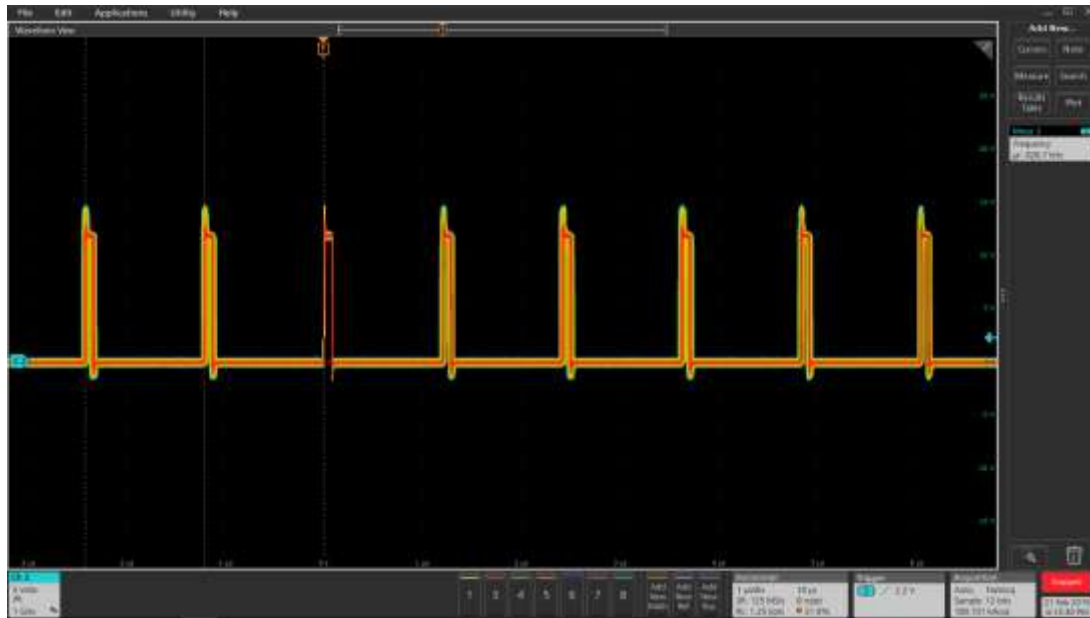

SW@0A
Ch 2: SW

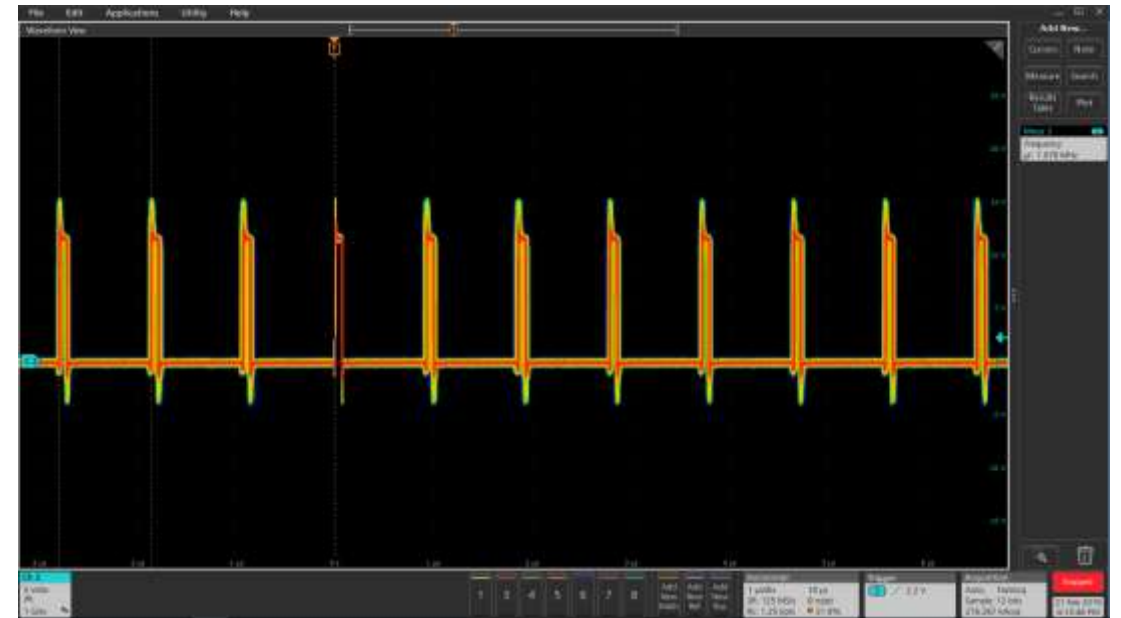

SW@6A
Ch 2: SW

Typical Operating Waveforms

PVin=12.0V, Vo=0.8V, Io=0-6A, Room Temperature, no airflow

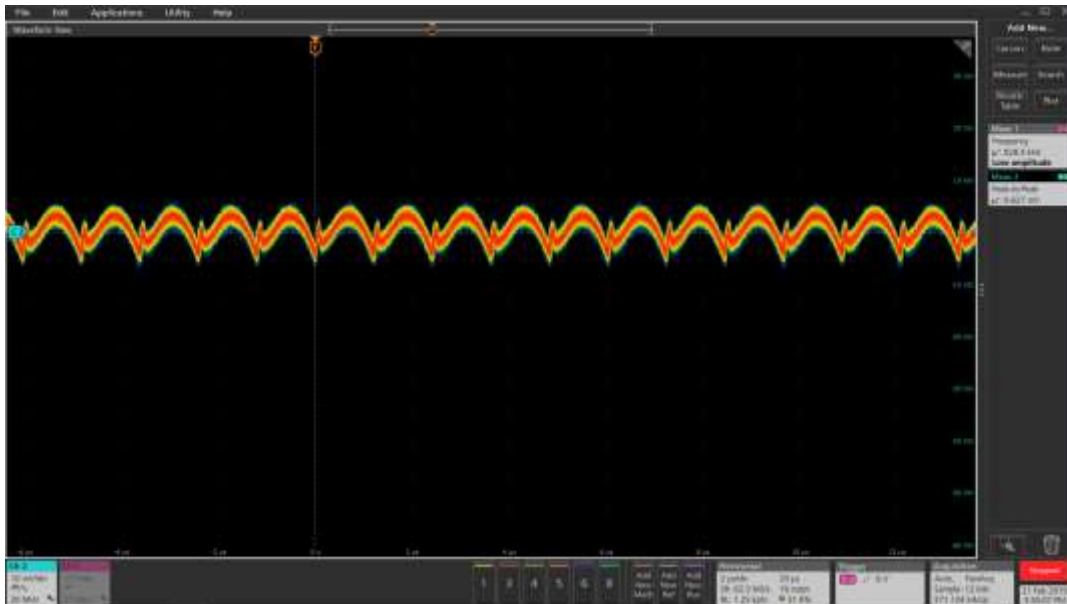

Vo ripple 10 mV @ 0 A
Ch2: Vo

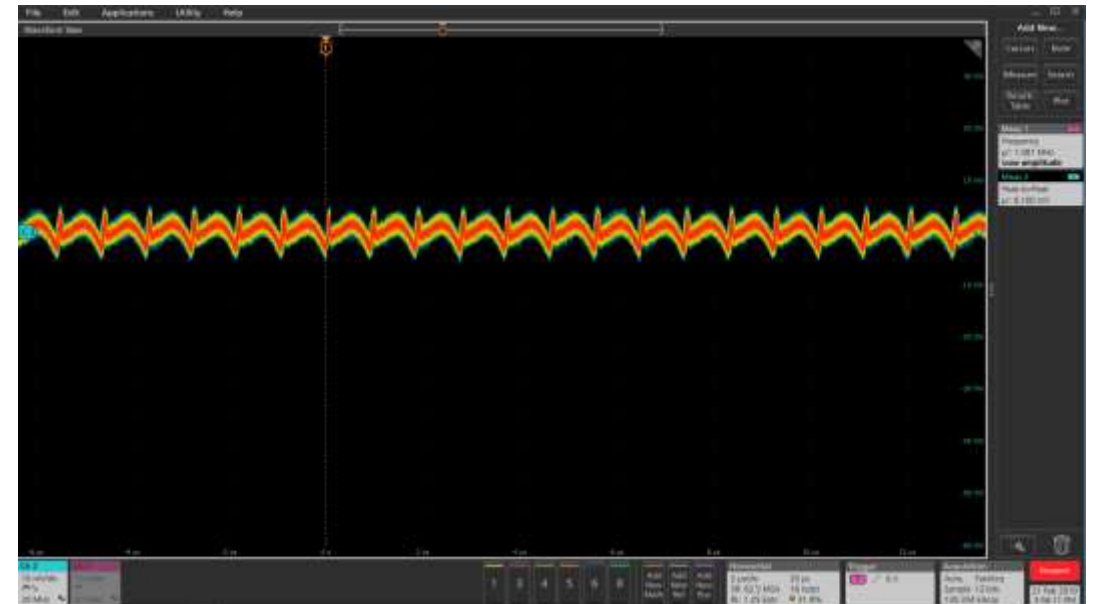

Vo ripple 8 mV @ 6 A
Ch2: Vo

Typical Operating Waveforms

PVin=12.0V, Vo=0.8V, Io=0-6A, Room Temperature, no airflow

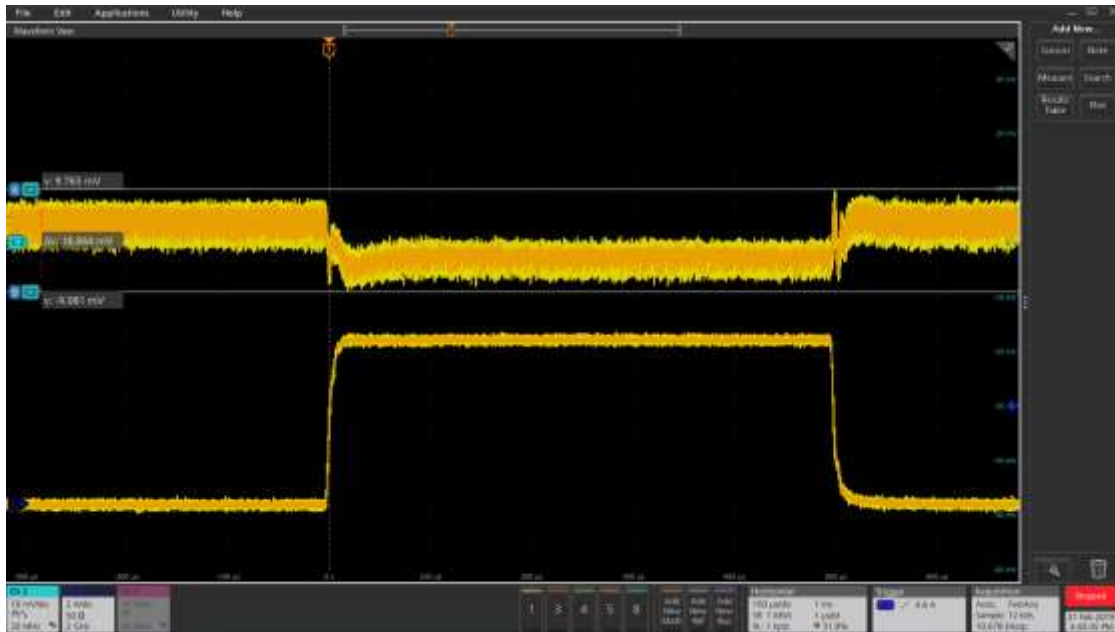

Load transient 0A-6A

Ch6: Io Ch2: Vo

Vo (p-p)=19mV

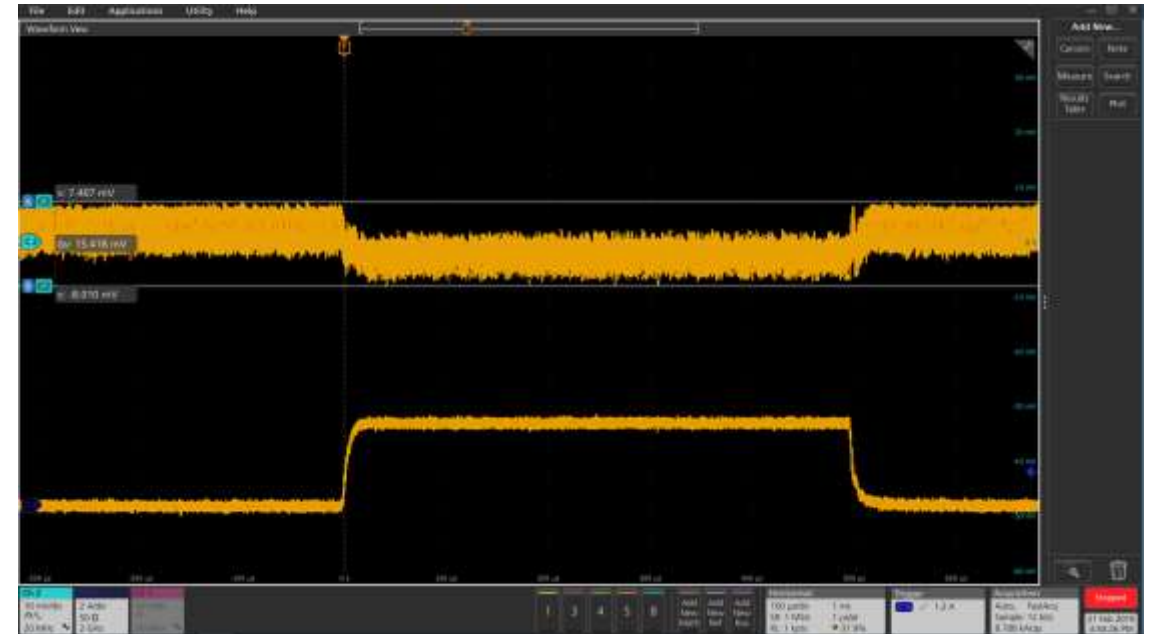

Load transient 0A-3A

Ch6: Io Ch2: Vo

Vo (p-p)=16mV

Typical Operating Waveforms

$P_{Vin}=12.0V$, $V_o=0.8V$, $I_o=0-6A$, Room Temperature, no airflow

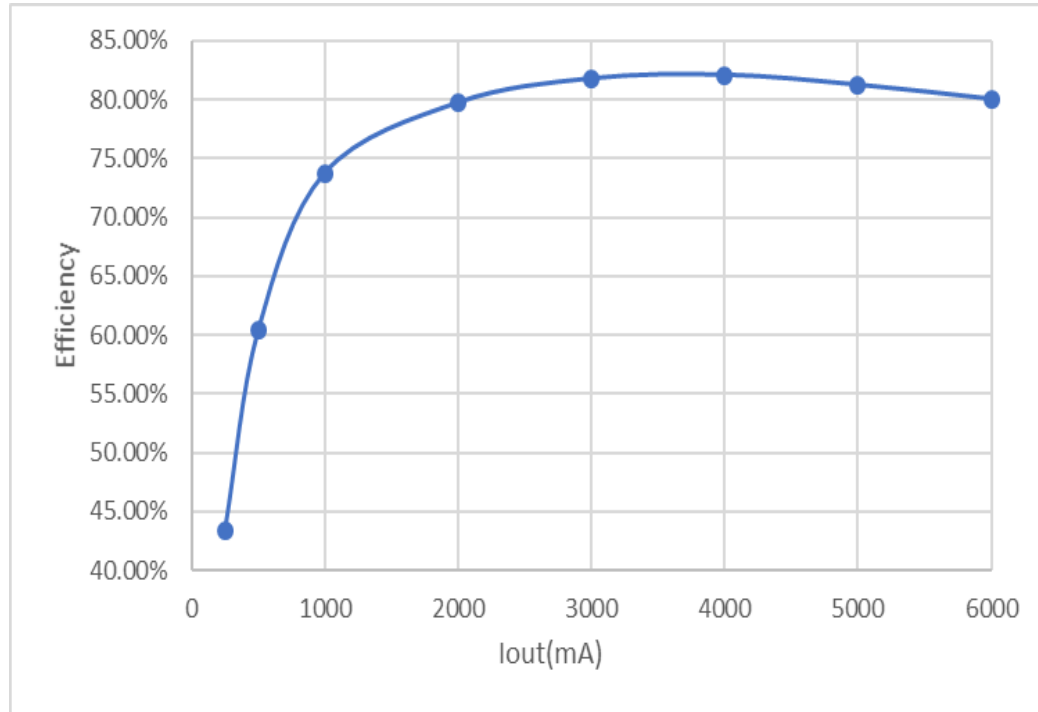

Efficiency

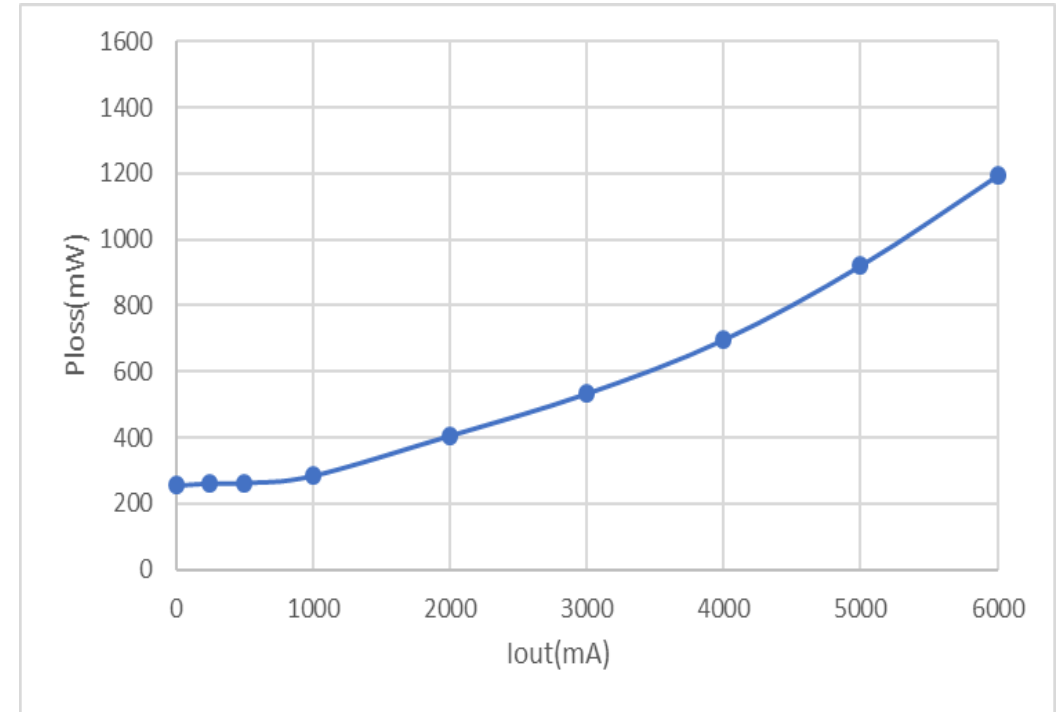

Power Loss

Typical Operating Waveforms

PVin=12.0V, Vo=0.8V, Io=0-6A, Room Temperature, no airflow

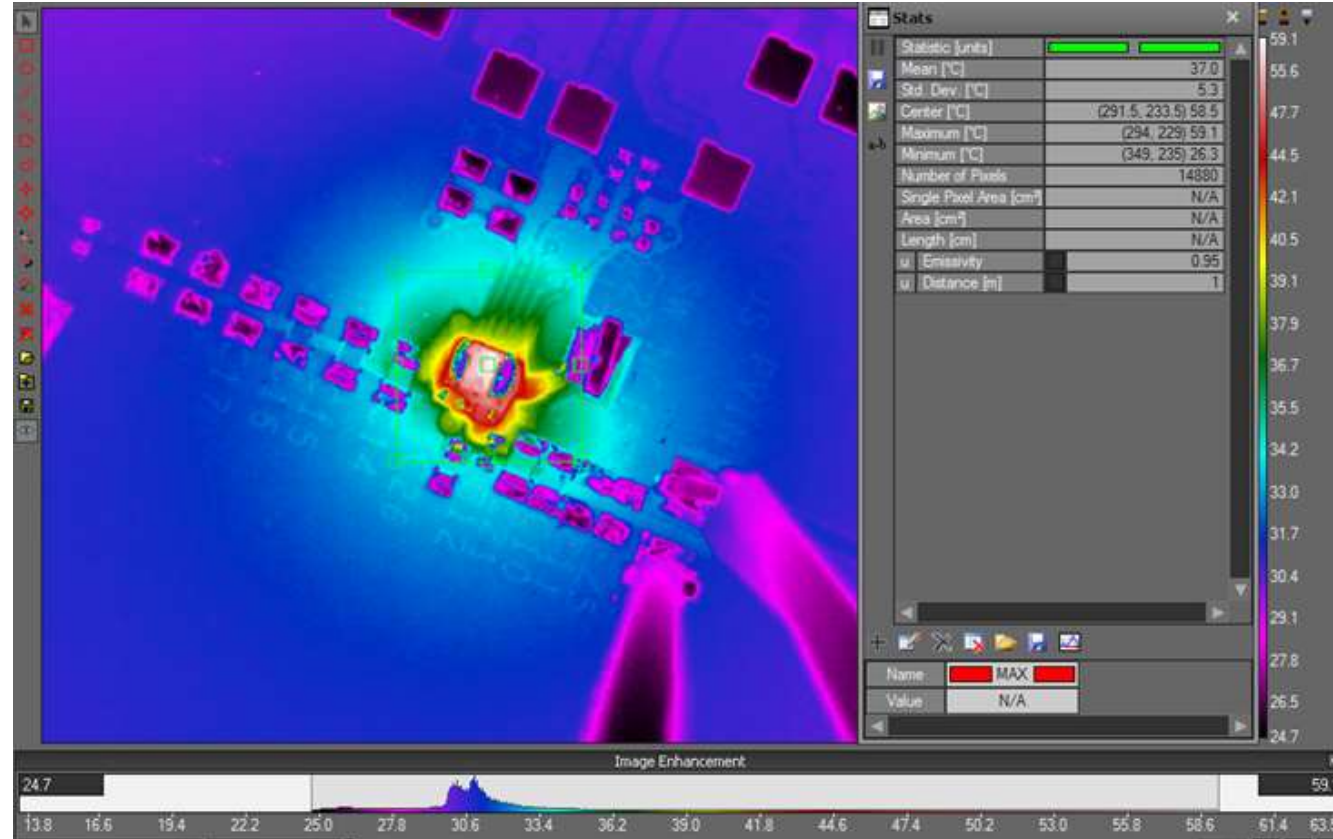

Io=6A
59°C

Typical Operating Waveforms

$P_{Vin}=12.0V$, $V_o=0.8V$, $I_o=0-6A$, Room Temperature, no airflow

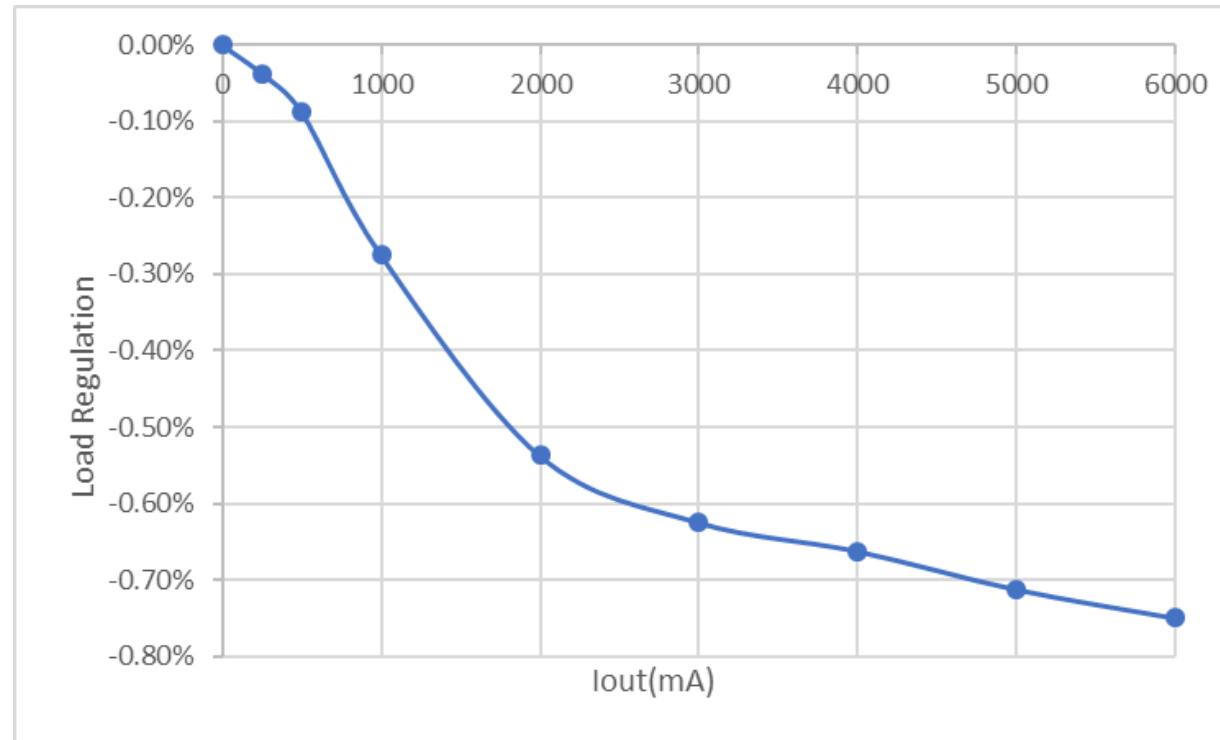

**$I_o=0A-6A$
Load Regulation**

Disclaimer

IMPORTANT NOTICE AND DISCLAIMER

TDK PROVIDES THIS POWER DESIGN USER GUIDE (“Resources”) “AS IS” AND WITH ALL FAULTS, AND DISCLAIMS. ALL WARRANTIES, EXPRESS AND IMPLIED, INCLUDING WITHOUT LIMITATION ANY IMPLIED WARRANTIES OF MERCHANTABILITY, FITNESS FOR A PARTICULAR PURPOSE OR NON-INFRINGEMENT OF THIRD PARTY INTELLECTUAL PROPERTY RIGHTS.

These Resources are intended for skilled developers designing with TDK products. You are solely responsible for (1) selecting the appropriate TDK products for your application, (2) designing, validating and testing your application, (3) ensuring your application meets applicable standards, and any other safety, security, or other requirements, and (4) ensuring your application complies with all applicable laws and regulations. These Resources are subject to change without notice and TDK assumes no responsibility for any notices or lack thereof. TDK grants you permission to use these Resources solely for development of an application that uses the TDK products described in the Resource.

This permission may be revoked at any time by TDK or any of its affiliates. Your use of these Resources shall be in compliance with all applicable laws and regulations including applicable export/import controls. Reproduction and display of these Resources is prohibited. No license is granted to any other TDK intellectual property right or to any third party intellectual property right. TDK disclaims responsibility for, and you agree to fully indemnify TDK, its affiliates and its representatives against, any claims, damages, costs, losses, and liabilities arising out of your use of these Resources.

