



Jan. 2022 Ver.3.0a  
TDK Corporation

## Multilayer Triplexer

For 450-960MHz / 1710-2690MHz / 3300-5925MHz

TPX Series 2.5x2.0mm [EIA 1008] TYPE

P/N: **TPX255925MT-7013A6**

## TPX255925MT-7013A6

### ■ SHAPES AND DIMENSIONS

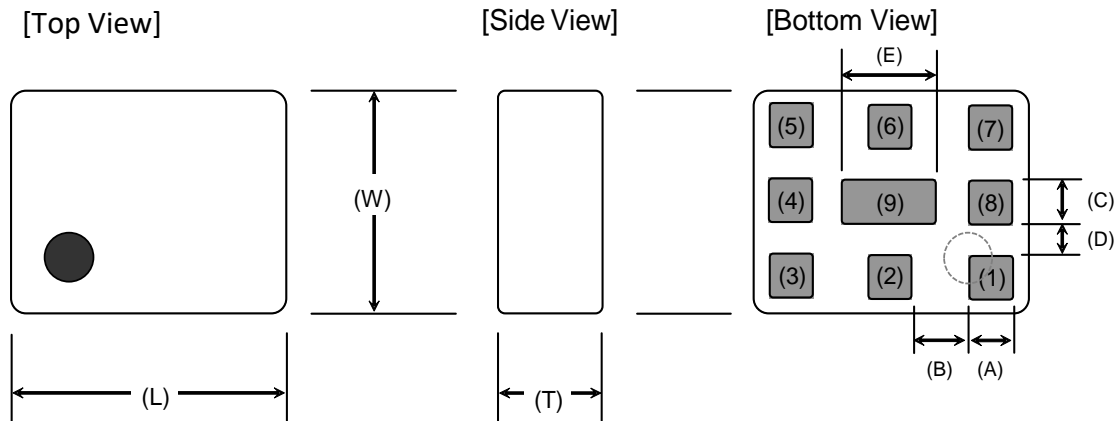

Dimensions (mm)

L	W	T	A	B	C	D	E
2.50	2.00	0.90	0.40	0.55	0.40	0.30	0.90
+/-0.10	+/-0.10	+/-0.10	+/-0.10	+/-0.10	+/-0.10	+/-0.10	+/-0.10

Terminal functions

(1)	High-Band Port
(2)	GND
(3)	Middle-Band Port
(4)	GND
(5)	Low-Band Port

(6)	GND
(7)	Common Port
(8)	GND
(9)	GND

### ■ TERMINATION FINISH

Material
Au plate

## TPX255925MT-7013A6

### ■ ELECTRICAL CHARACTERISTICS

( Measurement )

#### Low-Band

Parameter	Frequency (MHz)	TDK Spec		
		Min.	Typ.	Max.
Insertion Loss (dB)	450 to 960	-	0.34	0.45
Insertion Loss (dB) ( -40 to +85 °C )	450 to 960	-	-	0.55
VSWR (Common Port)	450 to 960	-	1.2	1.7
VSWR (Low-Band Port)	450 to 960	-	1.16	1.7
Attenuation (dB)	1710 to 2690	15	18	-
	3300 to 3400	20	28	-
	3400 to 3800	20	28	-
	3800 to 4200	20	25	-
	4400 to 5000	13	21	-
	5150 to 5925	13	17	-
Characteristic Impedance (ohm)		50 (Nominal)		

Ta = +25+/-5°C

#### Middle-Band

Parameter	Frequency (MHz)	TDK Spec		
		Min.	Typ.	Max.
Insertion Loss (dB)	1710 to 2690	-	0.58	0.75
Insertion Loss (dB) ( -40 to +85 °C )	1710 to 2690	-	-	0.90
VSWR (Common Port)	1710 to 2690	-	1.4	1.7
VSWR (Middle-Band Port)	1710 to 2690	-	1.4	1.7
Attenuation (dB)	450 to 960	15	18	-
	3300 to 3400	10	14	-
	3400 to 3800	13	16	-
	3800 to 4200	13	16	-
	4400 to 5000	13	16	-
	5150 to 5925	13	17	-
Characteristic Impedance (ohm)		50 (Nominal)		

Ta = +25+/-5°C

## TPX255925MT-7013A6

### ■ ELECTRICAL CHARACTERISTICS

( Measurement )

#### High-Band

Parameter	Frequency (MHz)	TDK Spec		
		Min.	Typ.	Max.
Insertion Loss (dB)	3300 to 3400	-	1.08	1.35
	3400 to 4200	-	0.73	0.90
	4400 to 5000	-	0.40	0.65
	5150 to 5925	-	0.34	0.65
Insertion Loss (dB) ( -40 to +85 °C )	3300 to 3400	-	-	1.60
	3400 to 4200	-	-	1.10
	4400 to 5000	-	-	0.80
	5150 to 5925	-	-	0.80
VSWR (Common Port)	3300 to 3400	-	1.4	2.0
	3400 to 4200	-	1.4	2.0
	4400 to 5000	-	1.2	2.0
	5150 to 5925	-	1.2	2.0
VSWR (High-Band Port)	3300 to 3400	-	1.4	2.0
	3400 to 4200	-	1.3	2.0
	4400 to 5000	-	1.2	2.0
	5150 to 5925	-	1.2	2.0
Attenuation (dB)	450 to 960	17	21	-
	1710 to 2690	15	18	-
Characteristic Impedance (ohm)		50 (Nominal)		

Ta = +25+/-5°C

#### Common

Parameter		Frequency (MHz)	TDK Spec		
			Min.	Typ.	Max.
Isolation (dB)	LB - MB	450 to 960	15	19	-
		1710 to 2690	15	18	-
	LB - HB	450 to 703	20	24	-
		703 to 803	20	23	-
		803 to 960	17	21	-
		3300 to 4200	20	24	-
		4400 to 5000	13	19	-
		5150 to 5925	13	16	-
	MB - HB	1710 to 2690	15	18	-
		3300 to 3400	10	20	-
		3400 to 3800	13	17	-
		3800 to 4200	13	17	-
		4400 to 5000	13	17	-
			5150 to 5925	13	18
Characteristic Impedance (ohm)		50 (Nominal)			

Ta = +25+/-5°C

All specifications are subject to change without notice.

TDK Technology - Proprietary and Confidential Information of TDK Group Companies

## TPX255925MT-7013A6

### ■ MAXIMUM RATINGS

Parameter		TDK Spec	Conditions
Operating temperature (°C)		-40 to +85 °C	
Storage temperature (°C)		-40 to +85 °C	
Power Handling (W) *1	Frequency (MHz)		
Low-Band	450 to 960	4	Duty 50%
Middle-Band	1710 to 2690	3	Duty 50%
High-Band	3300 to 5925	1	CW
Human Body Model : HBM	@Each Port (V)	+/-1000	100pF / 1500ohm
Machine Model : MM	@Each Port (V)	+/-150	200pF / 0ohm
Charged Device Model : CDM	@Each Port (V)	+/-500	Humidity : 60%RH max

\*1 : Refer to 3GPP TS 38.101-1 V15.2.0

# TPX255925MT-7013A6

## FREQUENCY CHARACTERISTICS

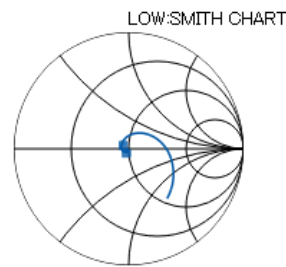
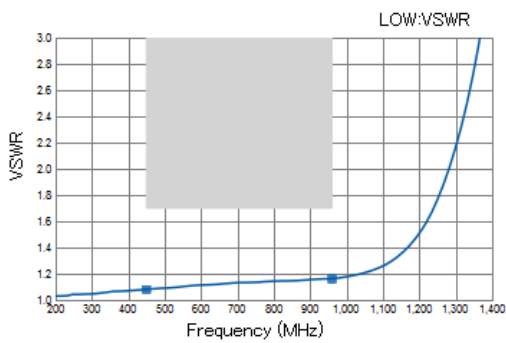
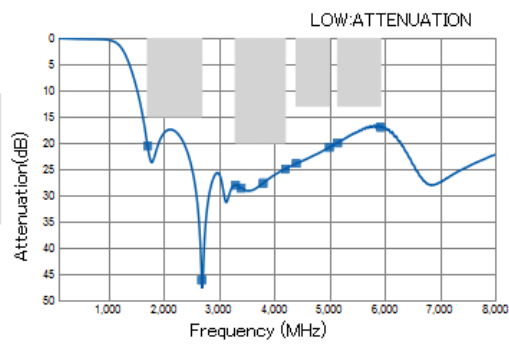
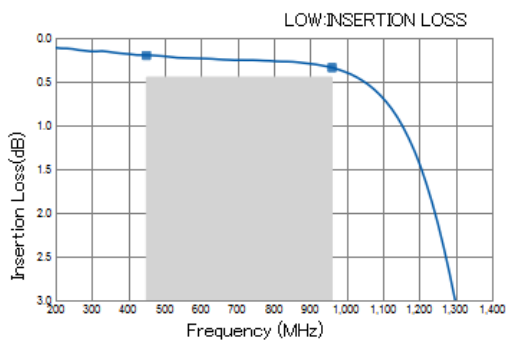

# TPX255925MT-7013A6

## FREQUENCY CHARACTERISTICS

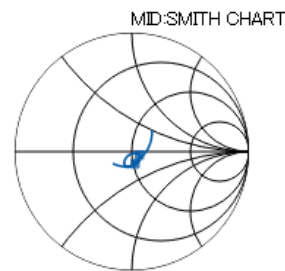
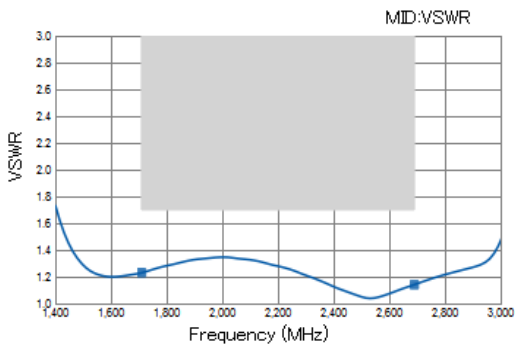
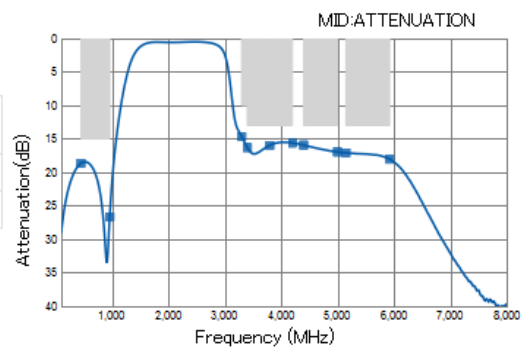
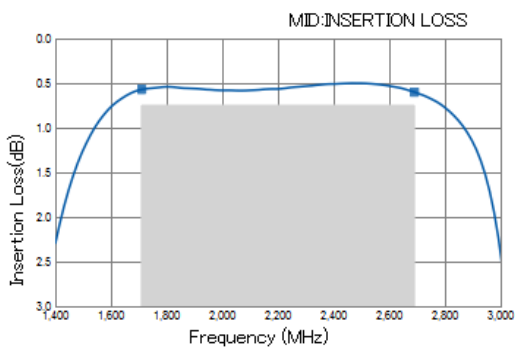

# TPX255925MT-7013A6

## FREQUENCY CHARACTERISTICS

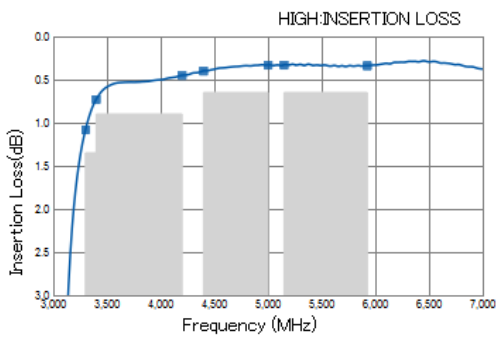

P/N	TPX255850MT-7013A6
3300	1.08
3400	0.73
4200	0.45
4400	0.40
5000	0.33
5150	0.33
5925	0.34

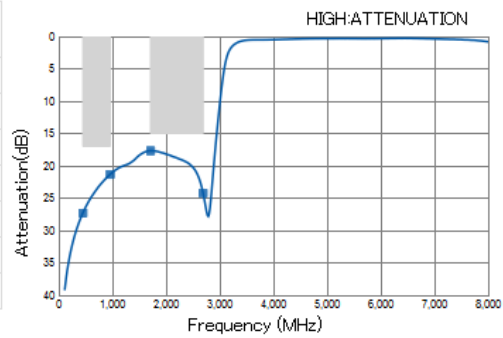

P/N	TPX255850MT-7013A6
450	27.28
960	21.30
1710	17.68
2690	24.22

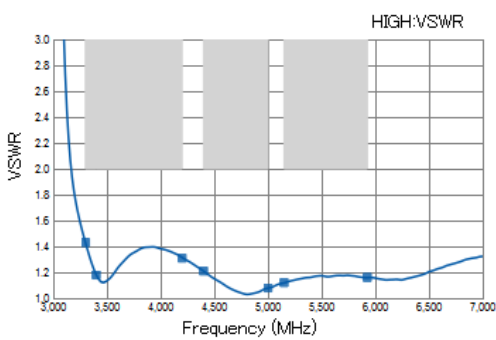

P/N	TPX255850MT-7013A6
3300	1.43
3400	1.18
4200	1.31
4400	1.21
5000	1.08
5150	1.12
5925	1.16

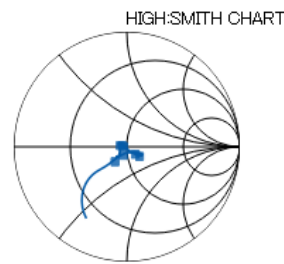

P/N	TPX255850MT-7013A6
3300	37.86 / -9.83
3400	45.69 / -6.72
4200	61.54 / -9.89
4400	56.91 / -7.41
5000	46.53 / 0.74
5150	45.07 / 1.84
5925	43.34 / 1.35



# TPX255925MT-7013A6

## FREQUENCY CHARACTERISTICS

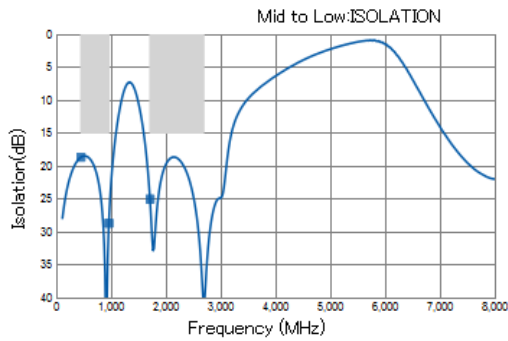

P/N	TPX255850MT-7013A6
Freq	
460	18.67
960	28.70
1710	25.05
2690	41.05

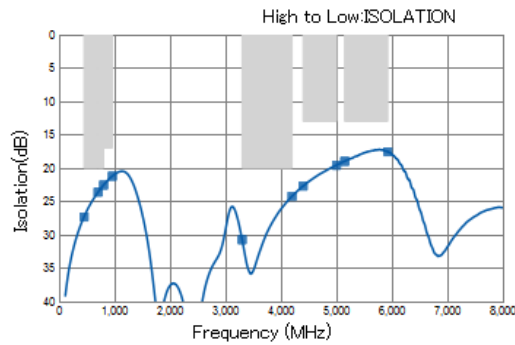

P/N	TPX255850MT-7013A6
Freq	
460	27.30
703	23.60
803	22.54
960	21.21
3300	30.74
4200	24.22
4400	22.68
5000	19.57
5150	18.98
5925	17.52

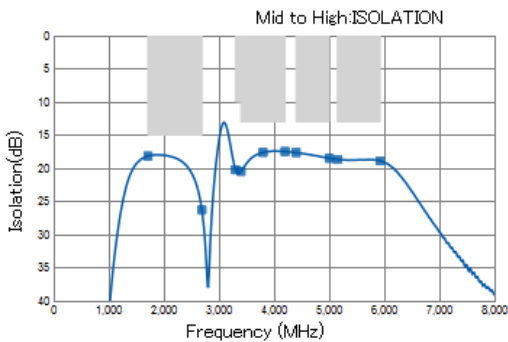

P/N	TPX255850MT-7013A6
Freq	
1710	18.15
2690	26.28
3300	20.20
3400	20.48
3800	17.61
4200	17.47
4400	17.64
5000	18.49
5150	18.64
5925	18.88

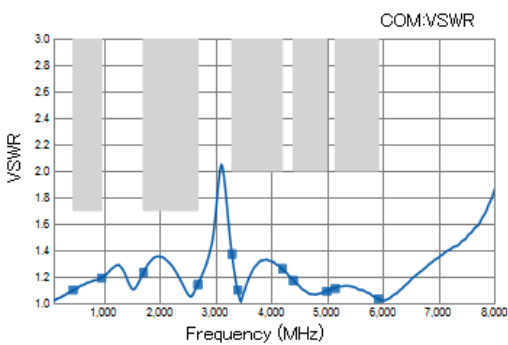

P/N	TPX255850MT-7013A6
Freq	
460	1.10
960	1.19
1710	1.23
2690	1.14
3300	1.37
3400	1.10
4200	1.26
4400	1.17
5000	1.09
5150	1.11
5925	1.08

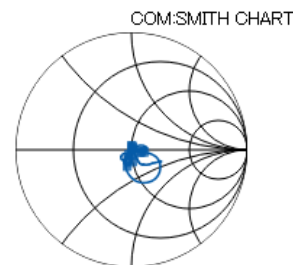

P/N	TPX255850MT-7013A6
Freq	
460	48.68 / -4.36
960	45.56 / -7.13
1710	48.67 / -10.15
2690	57.05 / -1.35
3300	43.06 / -12.74
3400	46.82 / -3.21
4200	62.71 / -1.4
4400	58.7 / -0.71
5000	49.73 / 4.44
5150	49.11 / 5.29
5925	50.08 / 1.53

## TPX255925MT-7013A6

### RECOMMENDED LAND PATTERN

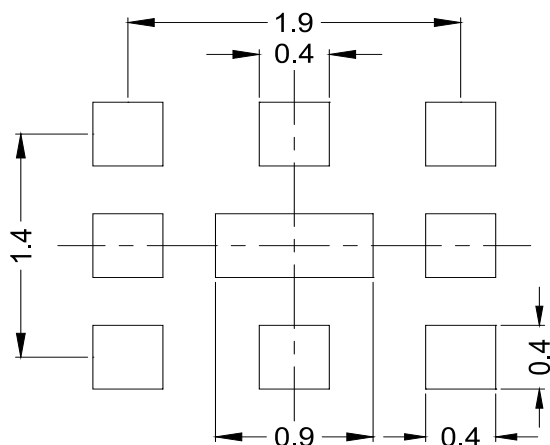

Unit : mm

### EVALUATION BOARD

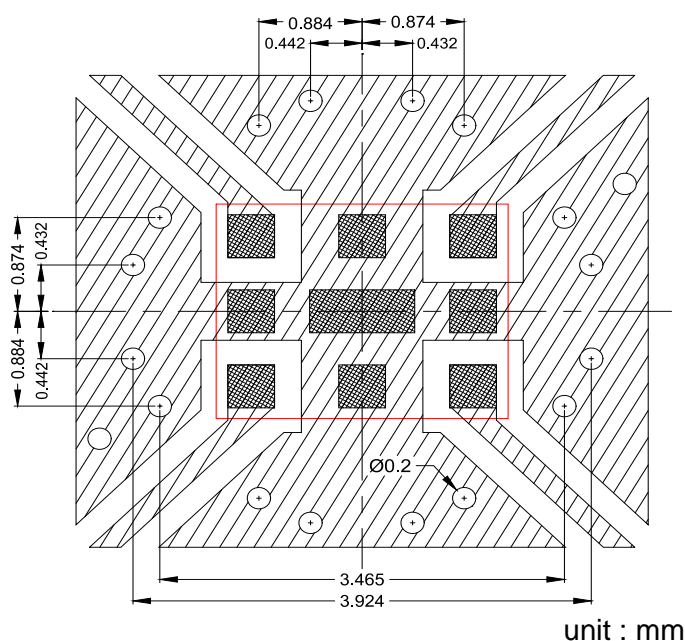

unit : mm

- Thru Hole
- Surface Pattern
- Land Pattern
- DUT

Material & Layer	Thickness
Copper Surface Pattern	0.035 mm
FR-4	0.10 mm
Inner GND	0.018 mm
FR-4	0.30 mm
Copper Bottom GND	0.035 mm

\* Line width should be designed to match 50 ohm characteristic impedance depending on PCB material and thickness.

\*\* The position of the through hole which have possibility of influence to the performance are indicated by dimension line.

### ENVIRONMENT INFORMATION

RoHS Statement  
RoHS Compliance

## TPX255925MT-7013A6

### RECOMMENDED REFLOW PROFILE

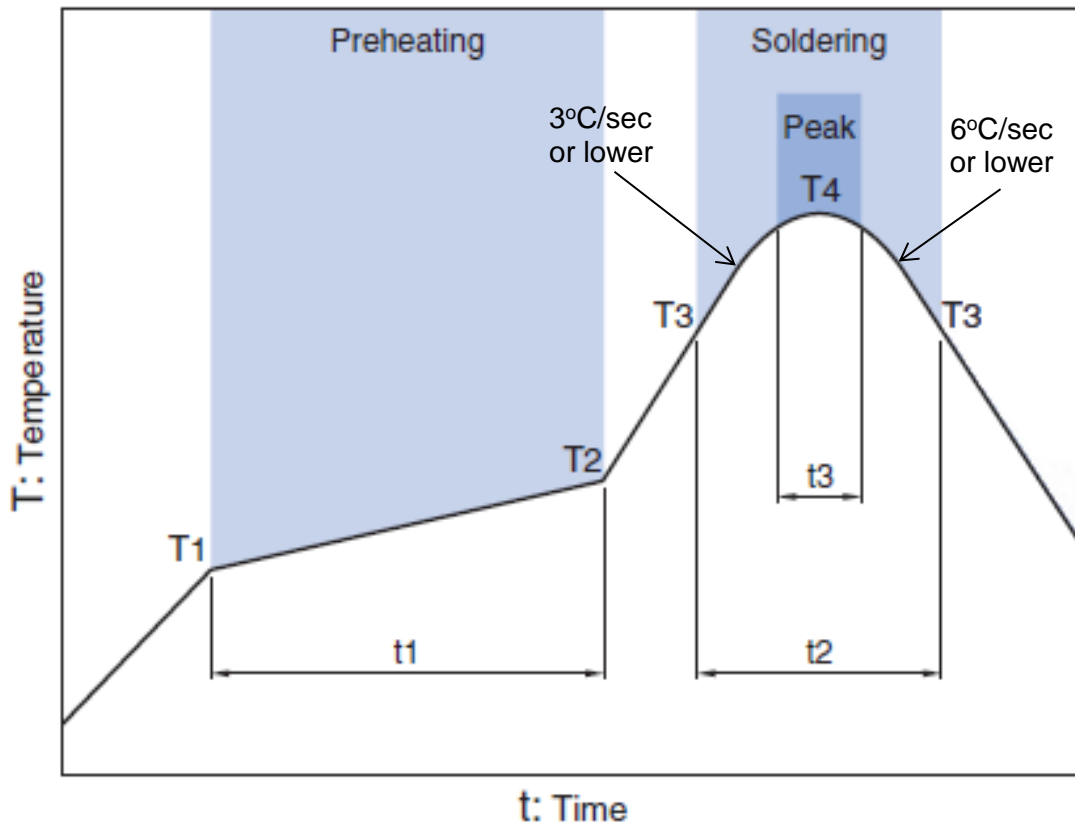

Preheating			Soldering			
			Critical zone (T3 to T4)		Peak	
Temp.		Time	Temp.	Time	Temp.	Time
T1	T2	t1	T3	t2	T4	t3 *
150°C	200°C	60 to 120sec	217°C	60 to 120sec	240 to 260°C	30 sec Max

\* t3 : Time within 5°C of actual peak temperature

The maximum number of reflow is 3.

Note: Lead free solder is recommended.  
Recommended solder is Sn-3.0Ag-0.5Cu. (M705 by Senju Metal Industry)

## TPX255925MT-7013A6

### PACKAGING STYLE

#### Reel Dimensions

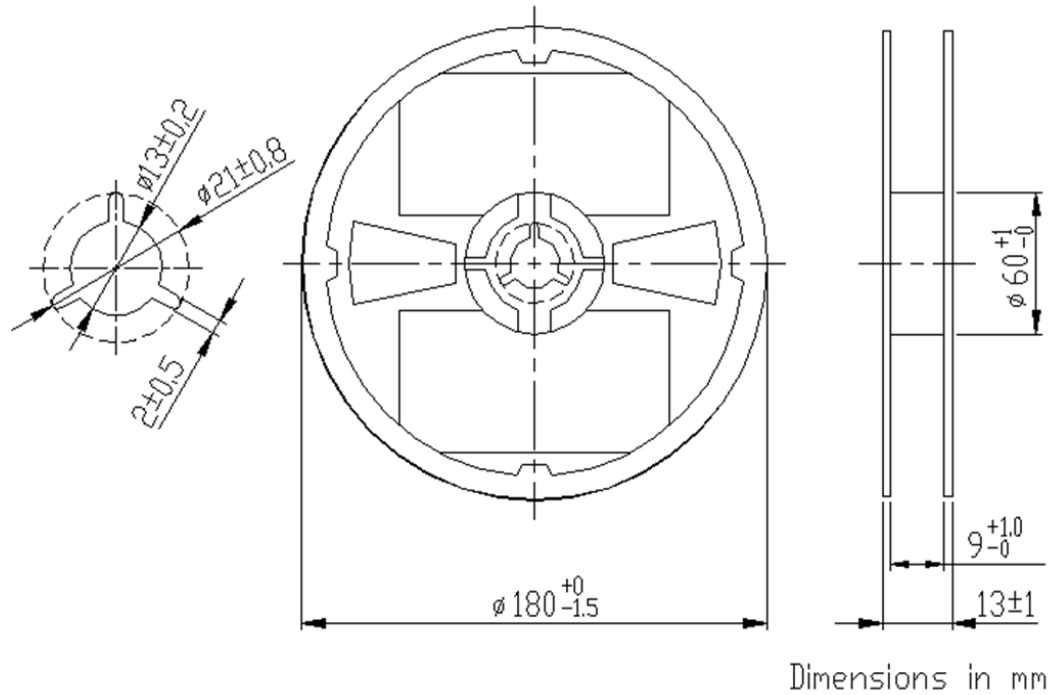

#### Carrier Tape

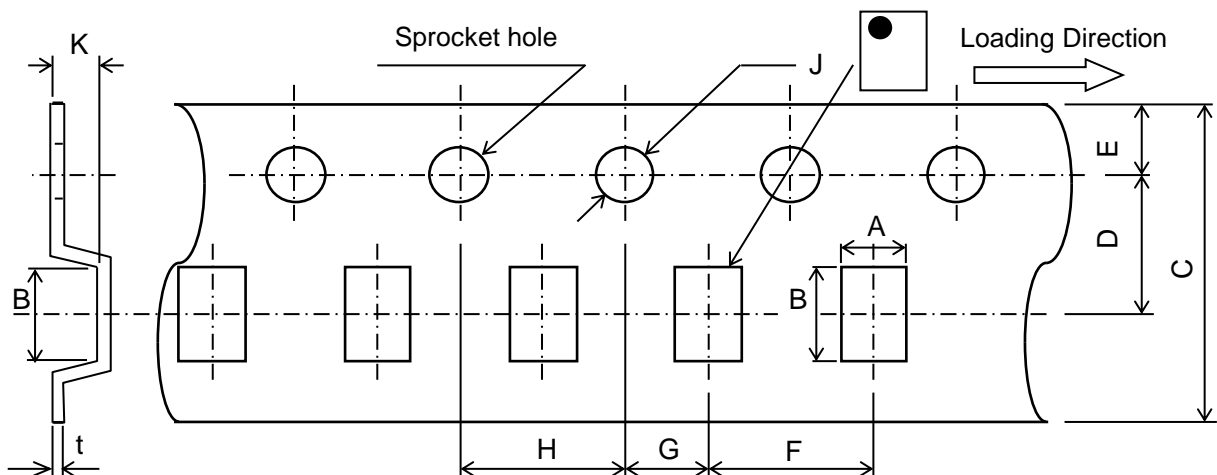

#### Dimensions (mm)

A	B	C	D	E	F	G	H	J	K	t
2.2	2.7	8.0	3.5	1.75	4.0	2.0	4.0	1.5	1.15	0.25
$\pm 0.05$	$\pm 0.05$	$+0.3/-0.1$	$\pm 0.05$	$\pm 0.1$	$\pm 0.1$	$\pm 0.05$	$\pm 0.1$	$+0.1/-0$	MAX	$\pm 0.05$

#### STANDARD PACKAGE QUANTITY

( pieces/reel )

2,000

All specifications are subject to change without notice.

TDK Technology - Proprietary and Confidential Information of TDK Group Companies

## REMINDERS FOR USING THESE PRODUCTS

Before using these products, be sure to request the delivery specifications.

### SAFETY REMINDERS

Please pay sufficient attention to the warnings for safe designing when using these products.

#### REMINDERS

The products listed on this catalog are intended for use in general electronic equipment (AV equipment, telecommunications equipment, home appliances, amusement equipment, computer equipment, personal equipment, office equipment, measurement equipment, industrial robots) under a normal operation and use condition.

The products are not designed or warranted to meet the requirements of the applications listed below, whose performance and/or quality require a more stringent level of safety or reliability, or whose failure, malfunction or trouble could cause serious damage to society, person or property.

Please understand that we are not responsible for any damage or liability caused by use of the products in any of the applications below or for any other use exceeding the range or conditions set forth in this catalog.

- |   |  |
|---|--|
| (1) Aerospace/Aviation equipment                                  | (8) Public information-processing equipment                                  |
| (2) Transportation equipment (cars, electric trains, ships, etc.) | (9) Military equipment   |
| (3) Medical equipment   | (10) Electric heating apparatus, burning equipment                           |
| (4) Power-generation control equipment                            | (11) Disaster prevention/crime prevention equipment                          |
| (5) Atomic energy-related equipment                               | (12) Safety equipment  |
| (6) Seabed equipment  | (13) Other applications that are not considered general-purpose applications |
| (7) Transportation control equipment                              |  |

When using this product in general-purpose applications, you are kindly requested to take into consideration securing protection circuit/equipment or providing backup circuits, etc., to ensure higher safety.