

SPECIFICATION

SPECIFICATION No.CHN0010

DATE: 2016.4.28

TDK TMR Angle Sensor

Product name

TAS2141-AAAB
(HHS-TAS2141AAAB-0010)

Product code

432A0C00

DIVISION	PRODUCT NAME	DATE.	PAGE
TDK	TAS2141-AAAB	2016.4.28	- 1 -

【 Changes】

Date	Rev	changes
2016.04.28	00	Initial Release
2016.05.13	01	Correct the TCoutput in page.7
2016.06.20	02	Update "10. Output Signal" in page.7
2016.07.15	03	Update "13. Package Dimension" in page.9
2016.11.07	04	Update "6. Absolute Maximum Rating" in page.5
2017.02.28	05	Update "12. Characteristics" in page.7-8

Contents

1. General description
2. Key Features
3. Typical Applications
4. Operation
5. Definition of Angle and Direction
6. Absolute Maximum Rating
7. Thermal Characteristics
8. Pin assignment
9. Internal circuit and Pin direction
10. Output Signal
11. Recommended Operating Conditions
12. Characteristics
13. Package dimension
14. Matters to be attended to

DIVISION	PRODUCT NAME	DATE.	PAGE
TDK	TAS2141-AAAB	2016.4.28	- 3 -

1. General description

The TAS2141-AAAB TDK Angle Sensor is Tunneling Magneto Resistance (TMR) sensor which consists of 2 Wheatstone bridges in TSSOP8 package, which output creates 1.5Vp-p @ Vcc 5V. The output can be configured to represent one pair of sine and cosine functions by applied magnetic field in x-y plane and its sensor can detect 360deg/ 1 rotation. Sine and cosine bridges are layout 90deg to one another. More than 20mT magnetic field is suitable for high precision angle measurement.

2. Key Features

- Magnetic field sensor, employing the TMR (Tunneling Magnet Resistance) effect.
- 2 full bridge (Sine and Cosine Outputs) in inside of TSSOP-8 package.
- Sine and Cosine Outputs.
- 2 element (2 full bridge each) /1 bare chip
- Very High Output Signal without Amplification.

3. Typical Applications

- Absolute Rotary Angle Sensor.
- EPS Motor-shaft Angle Sensor.
- Steering Wheel Angle Sensor.
- Pedal Position Sensor.
- Throttle Position Sensor.

DIVISION	PRODUCT NAME	DATE.	PAGE
TDK	TAS2141-AAAB	2016.4.28	- 4 -

4. Operation

Free layer aligns with Applied Magnetic Field.

Angle between Pin and Free layers determines resistance.

Magnetization direction of Free layer.

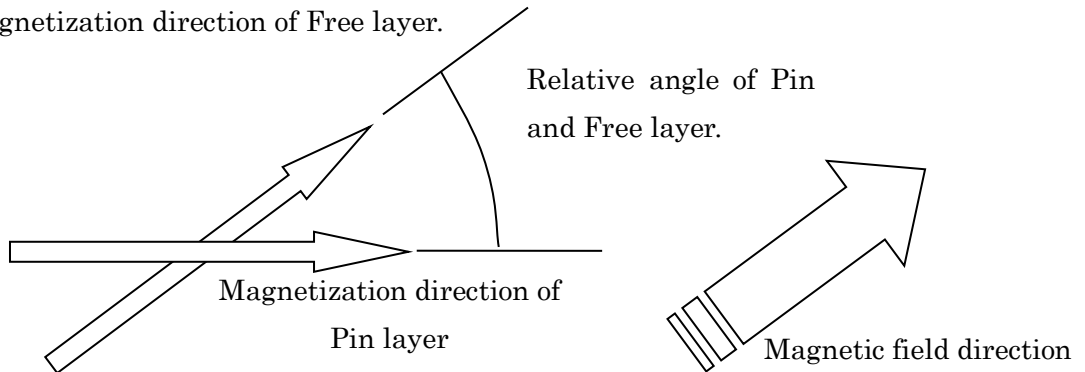

5. Definition of Angle and Direction

The definition of Direction of magnetic field detection is as follows.

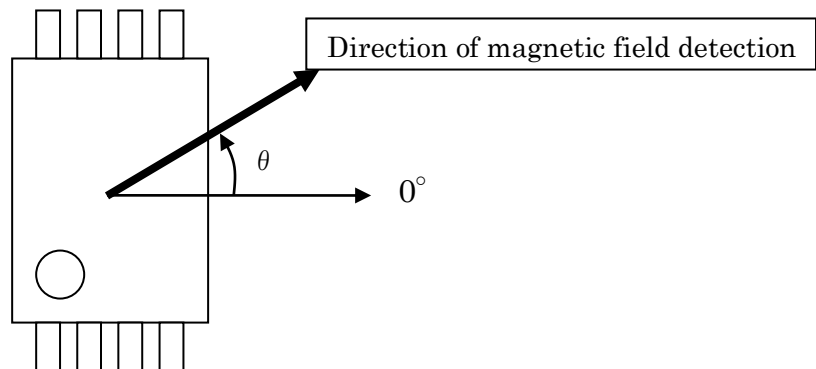

6. Absolute Maximum Ratings

Items	Parameter	Conditions	Min	Typ	Max	Unit	Remarks
Vcc	Supply Voltage				6.5	Volt	
Hex	External Magnetic field	Max. 5min @25degC			200	mT 1)	1)
ESD HBM	ESD tolerance : Human Body Model				4000	Volt	
ESD MM	ESD tolerance : Machine Model				400	Volt	
Topt	Operating Ambient Temperature		-40		150	deg C	
Tstg	Storage Temperature		-55		150	deg C	
Treflow	Reflow Temperature				260	deg C	

1) 1mT = 795.8A/m. in air

DIVISION	PRODUCT NAME	DATE.	PAGE
TDK	TAS2141-AAAB	2016.4.28	- 5 -

7. Thermal Characteristics

Items	Parameter	Conditions	Min	Typ	Max	Unit	Remarks
Rth(j-a)	Thermal Resistance from junction to ambient			200		K/W	

8. Pin assignment

No	Functions
1	-Sin
2	Vsin
3	+Sin
4	Gsin
5	+Cos
6	Vcos
7	-Cos
8	Gcos

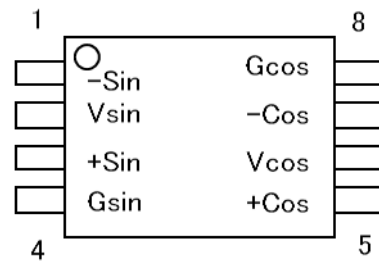

9. Internal circuit and Pin direction

White and gray arrows indicate magnetization direction of Pin layer.

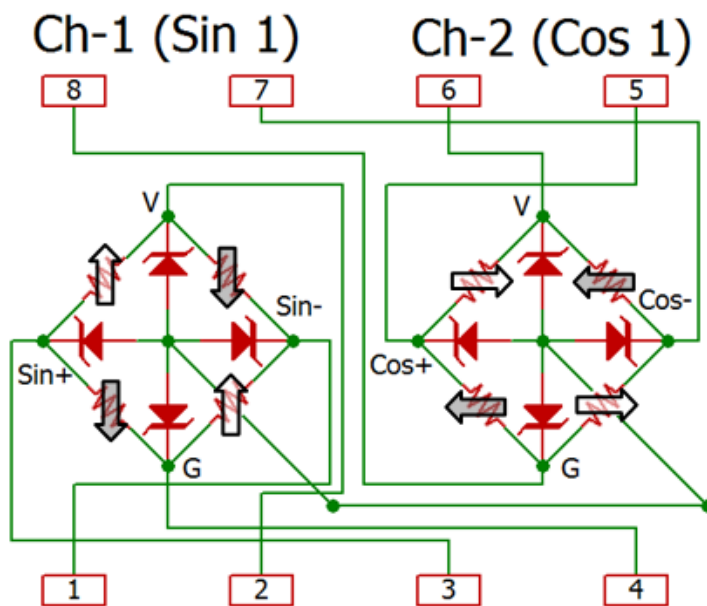

DIVISION	PRODUCT NAME	DATE.	PAGE
TDK	TAS2141-AAAB	2016.4.28	- 6 -

10. Output Signal (Differential Output Voltage)

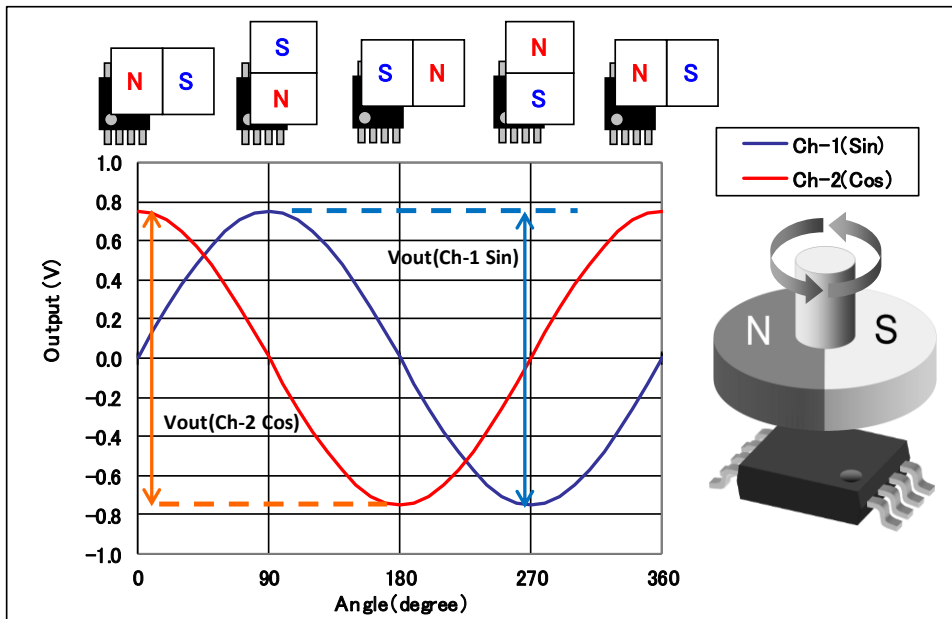

11. Recommended Operating Conditions

Items	Parameter	Conditions	Min	Typ	Max	Unit	Remarks
Vcc	Supply Voltage		3	5	5.5	Volt	
Topt	Operating Temperature		-40	25	150	degC	
Hex	External Magnetic Field	Recommended Range	20		80	mT	

12. Characteristics

TOPT=25° C, BEXT=30mT, VSIN=2.7 to 5.5V, VCOS=2.7 to 5.5V unless otherwise specified

Items	Parameter	Conditions	Min	Typ	Max	Unit	Remarks
Rbridge	Bridge Resistance	Topt=25degC, Hex=30mT	4	5	6	KΩ	
Vout	Differential output voltage peak to peak per Vcc	Topt=25degC, Hex=30mT	0.24	0.3	0.36	V/V	1)
Angle Error (After Compensation)		Topt=-40degC to 150degC Nominal magnetic Range: 20mT to 80mT 1000h			0.6	deg	2)
Orthogonality		Topt=-40degC to 150degC 20mT to 80mT 0h	87	90	93	deg	3)
Voffset	Differential Output Offset as an "initial offset"	per supply voltage 20mT to 80mT	-5	-	5	mV/V	
TCoutput	Temperature Coefficient of Differential Output	Topt=-40degC to 150degC 20mT to 80mT	-0.135	-0.115	-0.095	%/K	4)
TCRbridge	Temperature Coefficient of Bridge Resistance	Topt=-40degC to 150degC 20mT to 80mT	-0.070	-0.050	-0.030	%/K	5)
Off.TD	Offset Temperature Drift	Topt=-40degC to 150degC 20mT to 80mT	-0.5	0	0.5	mV/V	6)
Hyst	Hysteresis of Output Voltage	more than Hex=20mT	No Hysteresis				
k	Amplitude Synchronism ratio	Topt=25degC, Hex=30mT	97	100	103	%	7)
TCk	Temperature Coefficient of Amplitude Synchronism	Topt=-40degC to 150degC 20mT to 80mT	-0.015		0.015	%/K	8)

* LT=-40degC., RT=25degC., HT=150degC.

DIVISION	PRODUCT NAME	DATE.	PAGE
TDK	TAS2141-AAAB	2016.4.28	- 7 -

1) V_{p-p} =differential output voltage peak to peak

$$V_{out} = \frac{V_{p-p}}{V_{CC}}$$

2) Angle error is defined by zero-to-peak.

Angle error of either LT or HT is compensated using the correction factor at RT
(Offset, Gain and Phase compensation according TDK application note No. EAZ00010)

3) Orthogonality is defined by reference to the 90 deg.

$$4) \quad TC_{output} = \frac{(V_{out}(150degC) - V_{out}(-40degC))}{V_{out}(25degC) * (150degC - (-40degC))} * 100$$

$$5) \quad TC_{rbridge} = \frac{(R_{bridge}(150degC) - R_{bridge}(-40degC))}{R_{bridge}(25degC) * (150degC - (-40degC))} * 100$$

$$6) \quad Off.TD = V_{offset@Ta} - V_{offset@25degC}$$

※ $T_a = -40, 150degC$

$$7) \quad k = \frac{V_{cos\ peak}}{V_{sin\ peak}}$$

$$8) \quad TCk = \frac{k(150degC) - k(-40degC)}{150degC - (-40degC)}$$

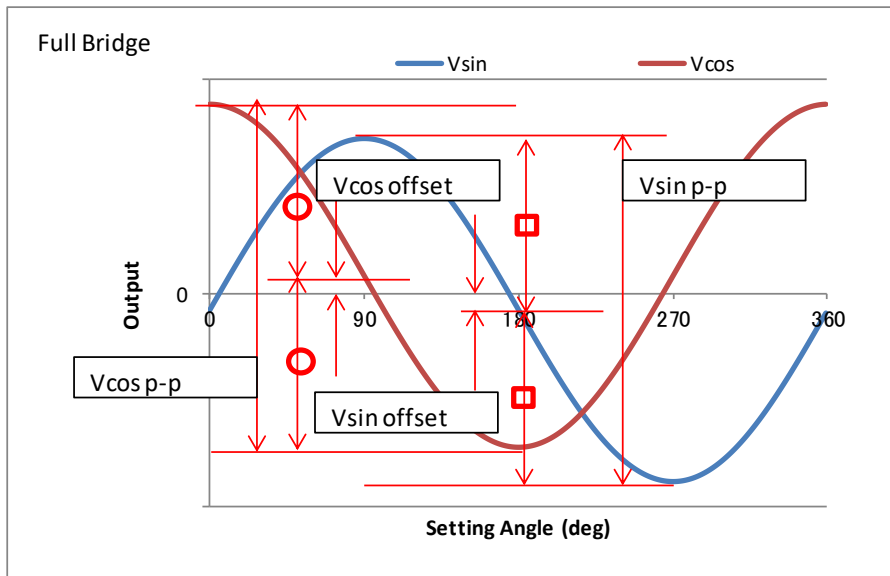

DIVISION	PRODUCT NAME	DATE.	PAGE
TDK	TAS2141-AAAB	2016.4.28	- 8 -

13. Package dimension unit: mm

2 full bridge / 1 package (TSSOP 8pin package 4.4mm x 3.0mm x 1.0mm)

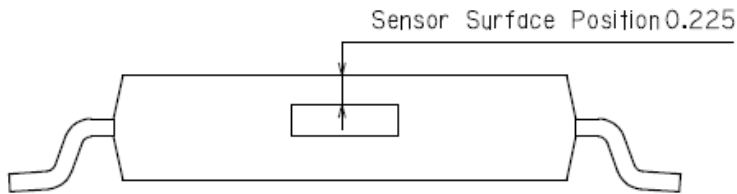
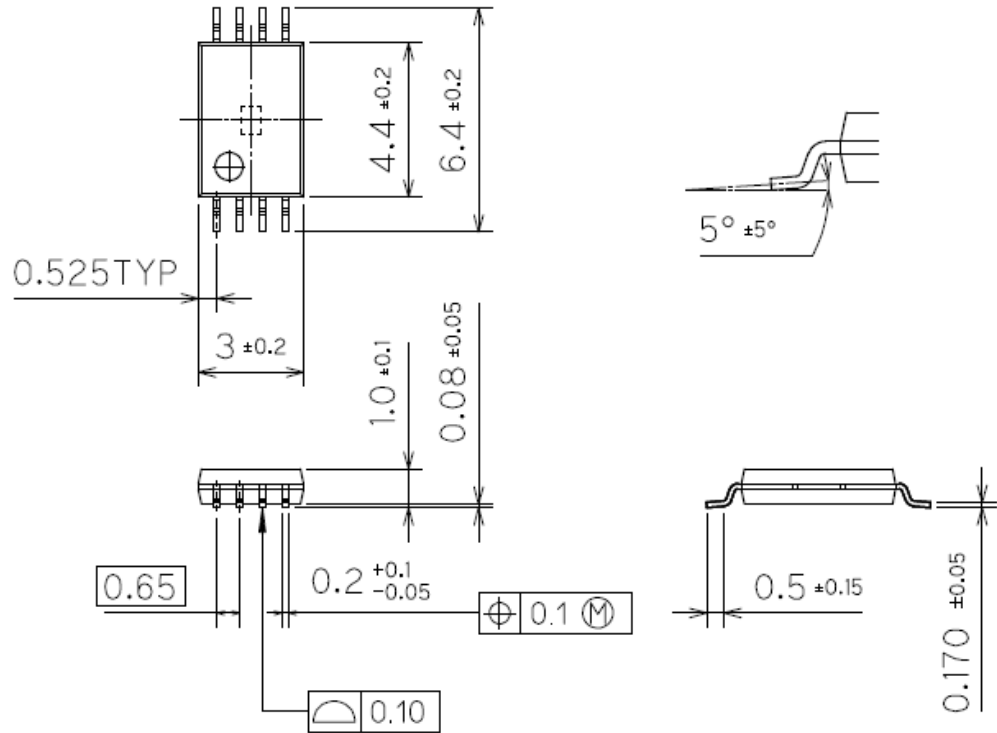

DIVISION	PRODUCT NAME	DATE.	PAGE
TDK	TAS2141-AAAB	2016.4.28	- 9 -

14. Matters to be attended to

- This material is under development product-information. All contents may change without notice.
- When you consider to use this product, please confirm to us that this material is up to date.
- We assume no responsibility that the infringement of third party rights caused by the information in this document.
- When you use this product to Equipment and equipment related to life purpose and potentially more serious damage, you must obtain agreement from us.
- Please note. We assume no responsibility If you have damage from its use without our agreement.

DIVISION	PRODUCT NAME	DATE.	PAGE
TDK	TAS2141-AAAB	2016.4.28	- 10 -