

JIS1005 [EIA 0402]

[NTCG104BH102HT1](#)

- ▶ UL certificate/E250289
- ▶ Max. Temp. 125°C
- ▶ General Grade



Dimension and Construction

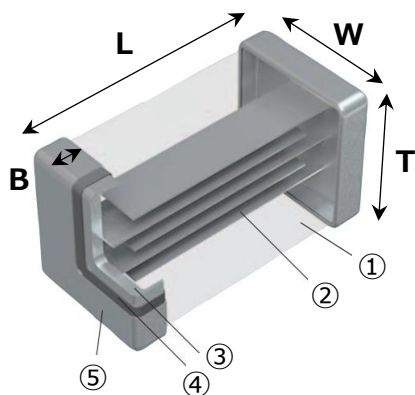

Symbol	Dimension
L	1.0±0.05mm
W	0.5±0.05mm
T	0.5±0.05mm
B	0.1mm min.

No.	Name
①	Semiconductor ceramics
②	Internal electrode
③	Base electrode
④	Ni plating
⑤	Sn plating

Electrical Characteristics

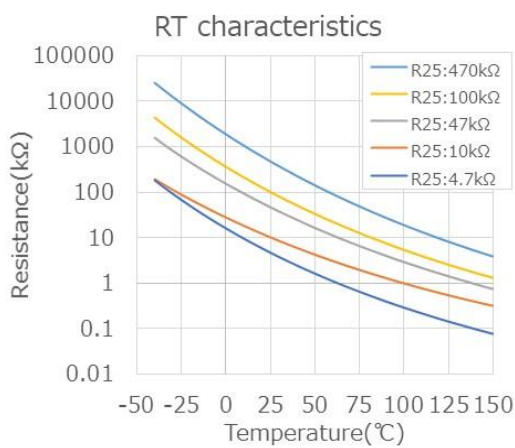

Item	Specification
Resistance	[at 25°C] 1kΩ±3%
B value	[at 25/50°C] 4096K typ. [at 25/85°C] 4100K±3%
Max. Rated power	[at 25°C] 100mW
Thermal Dissipation Constant	[at 25°C] 1mW/°C
Permissible Operating Current	[at 25°C] 1mA
Max. Voltage	5V
Operating Temperature	-40°C~125°C
1degC Step Data	[-40°C~125°C] Link

Package



Item	Specification
Packing	Taping (Paper carrier)
Reel Dimension	φ180mm
Packing Quantity	10,000pcs/reel
Weight	0.0013g