

Common Mode Filters

Aug. 28, 2018
Simple Model

Automotive Grade for Power Line / ACM90V series

Circuit Diagram

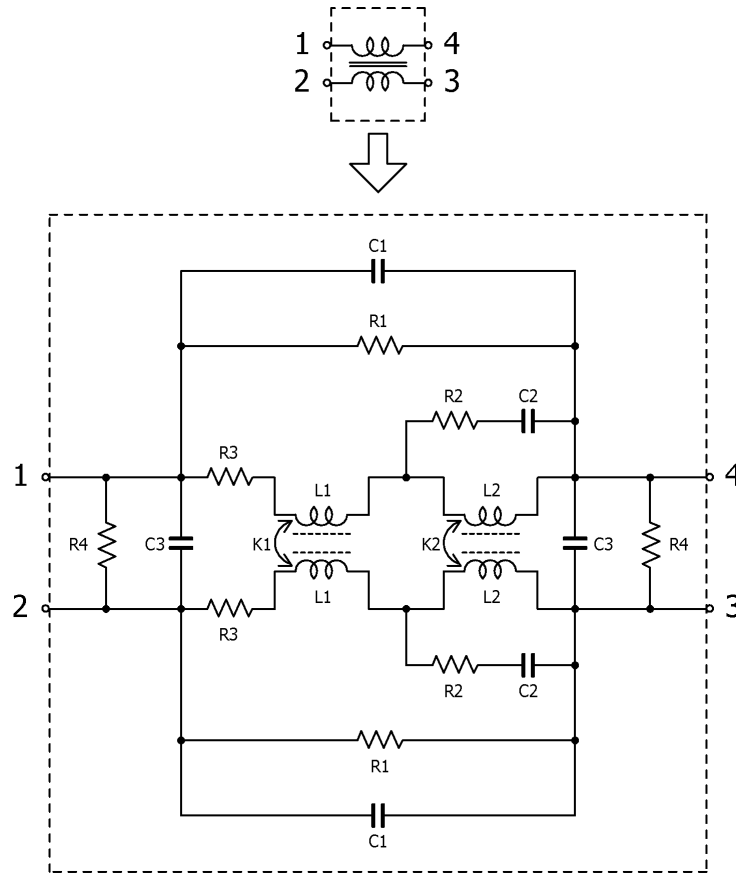

Circuit Parameters

Part No.	C1[pF]	C2[pF]	C3[pF]	L1[uH]	L2[uH]	R1[ohm]	R2[ohm]	R3[ohm]	R4[Gohm]	K1	K2
ACM90V-701-2PL-TL00	0.30	800	0.30	4	4	1,800	400	0.006	10	0.94	0.96