

Signal Line Common Mode Chokes/Filters

Feb. 27, 2026
Simple Model

Automotive Grade for Signal Line / ACT45R series

Circuit Diagram

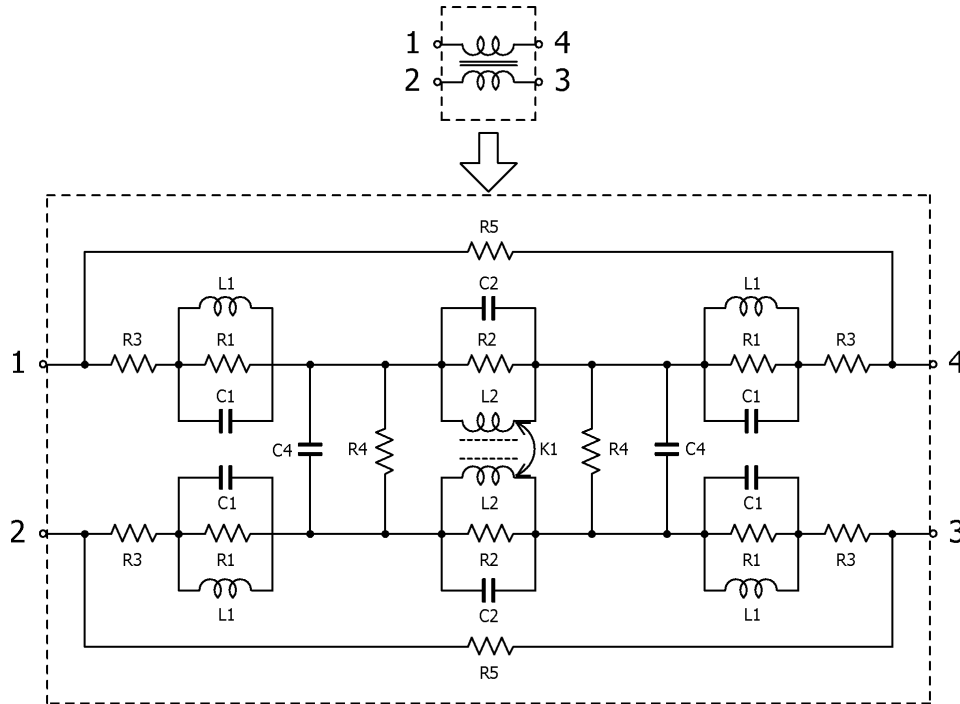

Circuit Parameters

Part No.	R1[ohm]	L1[nH]	C1[pF]	R2[ohm]	L2[nH]	C2[pF]	R3[ohm]	R4[Gohm]	C4[pF]	R5[Gohm]	K1
ACT45R-101-2P-TL001	29	31.7	0.01	50,100	100,000	0.074	0.525	1	11.70	1	1.00000