

Signal Line Common Mode Chokes/Filters

Feb. 27, 2026
Simple Model

Automotive Grade for Signal Line / MCZ1210AH series

Circuit Diagram

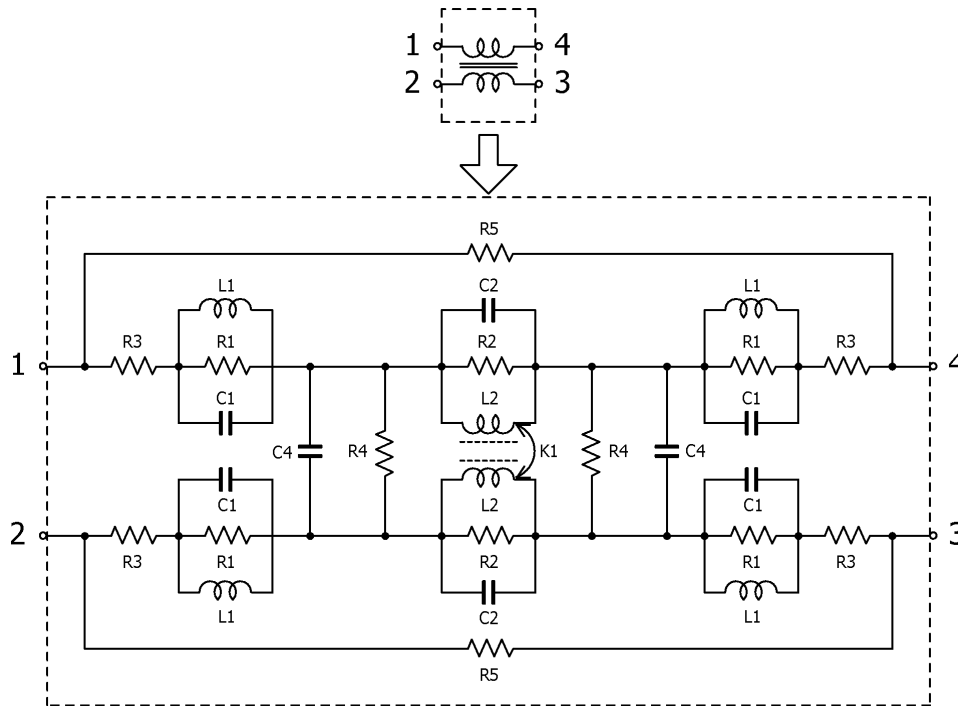

Circuit Parameters

Part No.	R1[ohm]	L1[nH]	C1[pF]	R2[ohm]	L2[nH]	C2[pF]	R3[ohm]	R4[Gohm]	C4[pF]	R5[Gohm]	K1
MCZ1210AH360L2TD0G	1,200	1.5	0.01	1,200	55.0	0.230	0.350	1	0.65	1	1.00000
MCZ1210AH900L2TD0G	1,200	2.0	0.01	950	140	0.150	0.500	1	0.65	1	1.00000